

ControlLogix Redundancy



Important User Information

Read this document and the documents listed in the additional resources section about installation, configuration, and operation of this equipment before you install, configure, operate, or maintain this product. Users are required to familiarize themselves with installation and wiring instructions in addition to requirements of all applicable codes, laws, and standards.

Activities including installation, adjustments, putting into service, use, assembly, disassembly, and maintenance are required to be carried out by suitably trained personnel in accordance with applicable code of practice.

If this equipment is used in a manner not specified by the manufacturer, the protection provided by the equipment may be impaired.

In no event will Rockwell Automation, Inc. be responsible or liable for indirect or consequential damages resulting from the use or application of this equipment.

The examples and diagrams in this manual are included solely for illustrative purposes. Because of the many variables and requirements associated with any particular installation, Rockwell Automation, Inc. cannot assume responsibility or liability for actual use based on the examples and diagrams.

No patent liability is assumed by Rockwell Automation, Inc. with respect to use of information, circuits, equipment, or software described in this manual.

Reproduction of the contents of this manual, in whole or in part, without written permission of Rockwell Automation, Inc., is prohibited

Throughout this manual, when necessary, we use notes to make you aware of safety considerations.



WARNING: Identifies information about practices or circumstances that can cause an explosion in a hazardous environment, which may lead to personal injury or death, property damage, or economic loss.



ATTENTION: Identifies information about practices or circumstances that can lead to personal injury or death, property damage, or economic loss. Attentions help you identify a hazard, avoid a hazard, and recognize the consequence.

IMPORTANT

Identifies information that is critical for successful application and understanding of the product.

Labels may also be on or inside the equipment to provide specific precautions.



SHOCK HAZARD: Labels may be on or inside the equipment, for example, a drive or motor, to alert people that dangerous voltage may be present.



BURN HAZARD: Labels may be on or inside the equipment, for example, a drive or motor, to alert people that surfaces may reach dangerous temperatures.



ARC FLASH HAZARD: Labels may be on or inside the equipment, for example, a motor control center, to alert people to potential Arc Flash. Arc Flash will cause severe injury or death. Wear proper Personal Protective Equipment (PPE). Follow ALL Regulatory requirements for safe work practices and for Personal Protective Equipment (PPE).

	Preface	9
	Summary of Changes	9
	Overview	9
	Additional Resources	9
	 Chapter 1	
About ControlLogix Redundancy Systems	Features of the ControlLogix Redundancy System	12
	Redundancy System Components	13
	I/O Modules in Redundancy Systems	14
	Redundancy System Operations	15
	System Qualification and Synchronization	15
	Switchovers	16
	Restrictions	18
	 Chapter 2	
Design a ControlLogix Redundancy System	Redundant Chassis	21
	Redundant Chassis Configuration Requirements	22
	Controllers in Redundant Chassis	22
	Redundancy Modules in Redundant Chassis	24
	Communication Modules in Redundant Chassis	25
	Power Supplies and Redundant Power Supplies in Redundancy Systems	27
	EtherNet/IP Networks with Redundant Systems	28
	Unicast Functionality	28
	Possible Communication Delays on EtherNet/IP and ControlNet Networks	28
	Bridge from an EtherNet/IP Network to a ControlNet Network	29
	ControlNet Networks with Redundant Systems	30
	ControlNet Network Requirements	30
	Redundant ControlNet Media	33
	Other Communication Networks	34
	I/O Placement	36
	1715 Redundant I/O Systems	36
Using HMI	38	
HMI Connected Via an EtherNet/IP Network	38	
HMI Connected Via a ControlNet Network	39	
	Optional Software	41

Install the Redundancy System	Chapter 3	
	Before You Begin.....	43
	Redundancy System Quick Start.....	43
	Install the Hardware.....	45
	Install the First Chassis.....	45
	Install the Redundancy Module.....	46
	Environment and Enclosure.....	47
	Prevent Electrostatic Discharge.....	47
	Removal and Insertion Under Power (RIUP).....	47
	European Hazardous Location Approval.....	48
	Safety-related Programmable Electronic Systems.....	48
	Optical Ports.....	48
	Small Form-factor Pluggable.....	48
	North American Hazardous Location Approval.....	49
	Laser Radiation Ports.....	50
	Install the Second Chassis.....	52
	Connect the Redundancy Modules.....	52
	Connect the Fiber-optic Communication Cable to Redundant Channels.....	54
	Connect the Fiber-optic Communication Cable to Single Channels.....	55
	Fiber-optic Cable.....	56
	Use Dual Fiber Ports with the 1756-RM2/A Redundancy Module.....	57
	Update Redundant Firmware.....	58
	Upgrade the Firmware in the First Chassis.....	58
	Upgrade the Firmware in the Second Chassis.....	61
	Designate the Primary and Secondary Chassis.....	61
	After Designation.....	62
	Conversion from a Non-redundant to a Redundant System... ..	62
	Qualification Status Via the RMCT.....	63
	Reset the Redundancy Module.....	63
	Remove or Replace the Redundancy Module.....	64
Configure the EtherNet/IP Network	Chapter 4	
	Requested Packet Interval.....	65
	CPU Usage.....	65
	IP Address Swapping.....	66
	Static Versus Dynamic IP Addresses.....	68
	Reset the IP Address for an EtherNet/IP Communication Module.....	68
	CIP Sync.....	69
	Produce/Consume Connections.....	72

	Configure EtherNet/IP Communication Modules in a Redundant System	73
	Before You Begin	73
	Options for Setting the IP Addresses of EtherNet/IP Communication Modules	74
	Half/Full Duplex Settings	74
	Use a Redundancy System with Device Level Ring	75
	Use a Redundancy System with Parallel Redundancy Protocol	76
	Chapter 5	
Configure the ControlNet Network	Produce/Consume Connections	77
	Network Update Time	79
	NUTs with Multiple ControlNet Networks	79
	Scheduled or Unscheduled Network	81
	Use a Scheduled Network	81
	Use an Unscheduled Network	81
	Add Remote ControlNet Modules While Online	82
	Schedule a New Network	82
	Update an Existing Scheduled Network	85
	Check the Network Keeper States	86
	Save the Project for Each Primary Controller	88
Automatic Keeper Crossloads	88	
	Chapter 6	
Configure the Redundancy Modules	About the Redundancy Module Configuration Tool (RMCT)....	89
	Determine If Further Configuration Is Required.....	90
	Use the RMCT	91
	Identify the RMCT Version.....	92
	Update the RMCT Version	93
	Module Info Tab.....	94
	Configuration Tab	96
	Auto-synchronization.....	97
	Chassis ID	98
	Enable User Program Control	98
	Redundancy Module Date and Time	98
	Synchronization Tab	99
	Commands in the Synchronization Tab	100
	Recent Synchronization Attempts Log	101
	Synchronization Status Tab	102
	System Update Tab	103
System Update Commands.....	104	
System Update Lock Attempts	107	
Locked Switchover Attempts	108	

Program the Redundant Controller

Chapter 7

- Configure the Redundant Controller 109
- Crossloads, Synchronization, and Switchovers 113
 - Changing Crossload and Synchronization Settings 113
 - Default Crossload and Synchronization Settings 114
 - Recommended Task Types 114
 - Continuous Task After Switchover 114
 - Multiple Periodic Tasks 116
- Crossloads and Scan Time 118
 - Estimate the Crossload Time 118
 - Redundancy Object Attributes for Crossload Times 118
 - Equation for Estimating Crossload Times 119
- Program to Minimize Scan Times 120
 - Use a ControlLogix 5570 Controller with a 1756-RM2/A Redundancy Module 120
 - Use Multiple Controllers 120
 - Minimize the Number of Programs 121
 - Manage Tags for Efficient Crossloads 122
 - Use Concise Programming 125
- Program to Maintain Data Integrity 127
 - Array (File)/Shift Instructions 127
 - Scan-dependent Logic 128
- Program to Optimize Task Execution 131
 - Specify a Larger System Overhead Time Slice 132
 - Change the System Overhead Time Slice 133
 - Use Periodic Tasks 135
- Conduct a Test Switchover 136
 - Synchronization After a Switchover 137
- Program Logic to Run After a Switchover 138
- Use Messages for Redundancy Commands 139
 - Verify User Program Control 139
 - Use an Unconnected Message 139
 - Configure the MSG Instruction 140
- Set the Task Watchdog 143
 - Minimum Value for the Watchdog Time 145
- Download the Project 145
- Store a Redundancy Project to Nonvolatile Memory 146
 - Store a Project While the Controller is in Program or Remote Program Mode 147
 - Store a Project While a System is Running 148
 - Load a Project 149
- Online Edits 149
 - Support for Partial Import Online 149
 - Plan for Test Edits 150
 - Finalize Edits with Caution 152
 - Reserve Memory for Tags and Logic 155

Monitor and Maintain a Redundancy System

Chapter 8

Controller Logging.....	157
Controller Log.....	158
Controller Logging in Redundancy Systems.....	158
Component Change Detection.....	158
Monitor System Status.....	159
Verify Date and Time Settings.....	161
Verify System Qualification.....	162
Check Qualification Status Via Module Status Displays.....	162
Check Qualification Status Via the RMCT.....	164
Check the EtherNet/IP Module Status.....	164
CPU Usage.....	165
Connections Used.....	165
Monitor the EtherNet/IP Network.....	165
Check the ControlNet Module Status.....	166
CPU Usage.....	167
Connections Used.....	167
Monitor the ControlNet Network.....	167

Troubleshoot a Redundant System

Chapter 9

General Troubleshooting Tasks.....	169
Check the Module Status Indicators.....	170
Use Programming Software to View Errors.....	171
Redundant Controller Major Fault Codes.....	173
Event Log Tab.....	174
Event Classifications.....	175
Access Extended Information about an Event.....	177
Interpret Extended Information for an Event.....	178
Export Event Log Data.....	178
Clear a Fault.....	183
System Event History.....	184
System Event History Column Descriptions.....	184
Edit a User Comment for a System Event.....	185
Save System Event History.....	185
Event Examples.....	186
Use the RMCT for Synchronization Attempts and Status.....	188
Recent Synchronization Attempts.....	188
Module-level Synchronization Status.....	189
Use the RMCT Event Log.....	190
Interpret Event Log Information.....	190
Export All Event Logs.....	194
Export Diagnostics.....	196
Contact Rockwell Automation Technical Support.....	198
Controller Events.....	198

	Keeper Status Causing Synchronize Failure.....	199
	Check the Module Status Display.....	199
	Check Keeper Status in RSNetWorx for ControlNet Software	199
	Valid Keeper Status and Signatures.....	200
	Partner Network Connection Lost	202
	Redundancy Module Connection Lost.....	204
	Redundancy Module Missing	205
	Qualification Aborted Due to a Non-redundant Controller	206
	Redundancy Module Status Indicators	207
	1756-RM2/A and 1756-RM2XT Status Indicators	207
	1756-RM/A and 1756-RM/B Status Indicators.....	210
	Redundancy Module Fault Codes and Display Messages	213
	Recovery Messages.....	214
	 Appendix A	
Convert from a Non-redundant System	Update the Configuration in Programming Software.....	216
	Replace Local I/O Tags.....	218
	Replace Aliases to Local I/O Tags.....	219
	Remove Other Modules from the Controller Chassis.....	220
	Add an Identical Chassis.....	221
	Upgrade to Redundancy Firmware.....	221
	Update the Controller Revision and Download the Project	221
	 Appendix B	
Redundancy Object Attributes	Table of Redundancy Object Attributes.....	223
	 Appendix C	
Redundancy System Checklists	Chassis Configuration Checklist.....	227
	Remote I/O Checklist	228
	Redundancy Module Checklist	228
	ControlLogix Controller Checklist	229
	ControlNet Checklist	230
	EtherNet/IP Module Checklist.....	231
	Project and Programming Checklist.....	232
	 Index	233

Summary of Changes

This table contains the changes that are made to this revision.

Topic	Page
Updated the HMI Blind Time Reduction During a Switchover section	17
Updated the section: Use a Redundancy System with Device Level Ring	75
Added the section: Use a Redundancy System with Parallel Redundancy Protocol	76
Updated Table 51 to reference firmware revision 31.052 and support for the 1756-EN2TP communication module.	220
Added the 1756-EN2TP communication module to tables in Appendix C: Redundancy System Checklists	227
RSLinX Enterprise is renamed FactoryTalk LinX	Throughout

Overview

This publication provides this information specific to redundancy systems:

- Design and planning considerations
- Installation procedures
- Configuration procedures
- Maintenance and troubleshooting methods

This publication is designed for use by anyone responsible for planning and implementing a ControlLogix® redundancy system:

- Application engineers
- Control engineers
- Instrumentation technicians

The contents of this publication are for anyone who already has an understanding of Logix 5000™ control systems, programming techniques, and communication networks.

IMPORTANT The 1756-RM2/A and 1756-RM2XT modules are interference-free regarding safety functions and can be used in ControlLogix SIL 2 applications.

Additional Resources

These documents contain additional information concerning related products from Rockwell Automation.

Table 1 - Additional Documentation

Resource	Description
1715 Redundant I/O System Specifications Technical Data, publication 1715-TD001	Contains specifications on a Redundant I/O system.
1756 ControlLogix Controllers Technical Data, publication 1756-TD001	Contains specifications on ControlLogix controllers and redundancy modules.
ControlFLASH™ Firmware Upgrade Software User Manual, publication 1756-UM105	Contains information on how to upgrade module firmware.
ControlLogix Redundancy Update and Module Replacement Guidelines Reference Manual, publication 1756-RM010	Provides instructions for replacing modules or updating firmware in a powered-up redundancy system.

Table 1 - Additional Documentation

Resource	Description
ControlLogix System Selection Guide, publication 1756-SG001	Provides information on how to select components for a ControlLogix system.
ControlLogix System User Manual, publication 1756-UM001	Contains information on how to install, configure, program, and operate a ControlLogix system.
ControlNet Network Configuration User Manual, publication CNET-UM001	Describes ControlNet® modules and how to use ControlNet modules with a Logix 5000 controller.
EtherNet/IP Parallel Redundancy Protocol Application Technique, publication ENET-AT006	Describes how to configure a Parallel Redundancy Protocol (PRP) network with the 1756-EN2TP EtherNet/IP™ communication module and a Stratix® 5400 or 5410 switch.
EtherNet/IP Device Level Ring Application Technique, publication ENET-AT007	Describes how to install, configure, and maintain linear and Device Level Ring (DLR) networks that use Rockwell Automation® EtherNet/IP devices with embedded switch technology.
EtherNet/IP Socket Interface Application Technique, publication ENET-AT002	Logix 5000 Describes the socket interface that you can use to program MSG instructions to communicate between a Logix 5000 controller via an EtherNet/IP module and Ethernet devices that do not support the EtherNet/IP application protocol.
EtherNet/IP Network Configuration User Manual, publication ENET-UM001	Describes how to use EtherNet/IP communication modules with your Logix 5000 controller and communicate with various devices on the Ethernet network.
Integrated Architecture and CIP Sync Configuration Application Technique, publication IA-AT003	Provides an explanation of CIP Sync™ technology and how you can synchronize clocks within the Rockwell Automation Integrated Architecture®.
Logix 5000 Controllers Common Procedures Programming Manual, publication 1756-PM001	Provides links to a collection of programming manuals that describe how to use procedures that are common to all Logix 5000 controllers projects.
Logix 5000 Controllers General Instructions Reference Manual, publication 1756-RM003	This manual provides details about each available instruction for a Logix-based controller.
Logix 5000 Controllers Information and Status Programming Manual, publication 1756-PM015	Describes how Logix 5000 controllers use connections with other devices.
Logix 5000 Controllers I/O and Tag Data Programming Manual, publication 1756-PM004	Provides information on how to access I/O and tag data in Logix 5000 controllers.
Logix 5000 Controllers Major, Minor, and I/O Faults Programming Manual, publication 1756-PM014	Describes how to monitor and handle major and minor controller faults.
Logix 5000 Controllers Nonvolatile Memory Card Programming Manual, publication 1756-PM017	Provides information on how to access and use a memory card in Logix 5000 controllers.
Logix 5000 Produced and Consumed Tags Programming Manual, publication 1756-PM011	Provides information to produce and consume system-shared tags and produce a large array with a Logix 5000 controller.
Logix 5000 Controllers Quick Start, publication 1756-QS001	Provides information to program and maintain Logix 5000 controllers.
Logix 5000 Controllers Tasks, Programs, and Routines Programming Manual, publication 1756-PM005	Provides information to configure controller tasks and the programs and routines for the proper execution of these tasks.
PlantPAx Process Automation System Reference Manual, publication PROCES-RM001	Elaborates on the application rules that are required to configure a PlantPAx® system.
Using ControlLogix in SIL 2 Applications Safety Reference Manual, publication 1756-RM001	Provides safety-related information specific to the use of ControlLogix modules in SIL 2 systems.
Redundant I/O System User Manual, publication 1715-UM001	Contains information on how to install, configure, program, operate, and troubleshoot a Redundant I/O system.
Industrial Automation Wiring and Grounding Guidelines, publication 1770-4.1	Provides general guidelines for installing a Rockwell Automation industrial system.
Product Certifications website, http://www.rockwellautomation.com/global/certification/overview.page	Provides declarations of conformity, certificates, and other certification details.

You can view or download publications at <http://www.rockwellautomation.com/global/literature-library/overview.page>. To order paper copies of technical documentation, contact your local Allen-Bradley distributor or Rockwell Automation sales representative.

About ControlLogix Redundancy Systems

Topic	Page
Features of the ControlLogix Redundancy System	12
Redundancy System Components	13
Redundancy System Operations	15
Restrictions	18

The ControlLogix® Redundancy System is a system that provides greater availability. The system has greater availability because it uses a redundant chassis pair. The redundant chassis pair maintains process operation when events, such as a fault on a controller, occur that stop process operation on non-redundant systems.

The redundant chassis pair includes two synchronized ControlLogix chassis with identically specific components in each. For example, one redundancy module and at least one ControlNet® or EtherNet/IP™ communication module are required.

Controllers are typically used in redundancy systems, but are not required if your application only requires communication redundancy. Your application operates from a primary chassis, but can switch over to the secondary chassis and components if necessary.

Features of the ControlLogix Redundancy System

The software and hardware components that are required to configure and use a ControlLogix redundancy system provide these features:

- Redundancy module speeds of up to 1000 Mbps when using a 1756-RM2/A module with another 1756-RM2/A module. Redundancy module speeds up to 100 Mbps when using a 1756-RM/A with another 1756-RM/A module, and a 1756-RM/B module with another 1756-RM/B module.
- Redundant fiber ports for crossloading; no single point of failure of a fiber cable.
- Plug-and-play-style commissioning and configuration that does not require extensive programming.
- ControlNet and EtherNet/IP network options for the redundant chassis pair.
- Easy-to-use, fiber-optic communication cable that connects redundant chassis pairs. Use the same cable for the 1756-RM2/A or 1756-RM/B modules.
- Simple redundant controller configuration by using a checkbox in the Controller Properties dialog box in the Studio 5000 Automation & Engineering Design Environment® programming software.
- A redundancy system ready to accept commands and monitor the redundant system states after basic installation, connection, and powerup.
- Switchovers occur as fast as 20 ms.
- Support for these FactoryTalk® applications for Ethernet communication modules:
 - FactoryTalk Alarms and Events
 - FactoryTalk Batch
 - FactoryTalk PhaseManager™
- Support for CIP Sync™ technology over an EtherNet/IP network to establish time coordination across the redundant system.
- Access to remote I/O modules over an EtherNet/IP network.
- Access to 1715 Redundant I/O systems over an EtherNet/IP network.
- Ethernet socket support.
- Supports DLR topologies. For more information about DLR, see the EtherNet/IP Device Level Ring Application Technique, publication [ENET-AT007](#).

Features Not Supported

- Any motion feature
- Any SIL 3 functional safety feature within the redundancy controllers
- Firmware Supervisor
- Event Tasks

IMPORTANT For Ethernet modules, signed and unsigned firmware are available. Signed modules provide the assurance that only validated firmware can be upgraded into a module.

Signed and unsigned firmware:

- Both signed and unsigned firmware are available.
- Product is shipped with unsigned firmware. To obtain signed firmware, you must upgrade the firmware for your product.
- To obtain signed and unsigned firmware, go to <http://www.rockwellautomation.com/global/support/firmware/overview.page>.
- Once signed firmware is installed, subsequent firmware updates must be signed also.

There are no functional/feature differences between signed and unsigned communication modules.

Redundancy System Components

Communication between a redundant chassis pair that includes components that match components makes redundancy possible.

Each chassis in the redundant chassis pair contains these ControlLogix components:

- One ControlLogix power supply - Required
- One ControlLogix redundancy module - Required
- Redundancy modules link the redundant chassis pair to monitor events in each of chassis and initiate system responses as required.
- At least one ControlLogix ControlNet or EtherNet/IP communication module - up to seven, optional (any combination)
- At least one controller - up to two controllers in the same family, optional

In addition, redundant chassis are connected to other components outside the redundant chassis pair, for example, remote I/O chassis or human machine interfaces (HMIs).

For more information about components you can use in a redundancy system, see [Chapter 2, Design a ControlLogix Redundancy System on page 21](#).

I/O Modules in Redundancy Systems

In a redundancy system, you can use only I/O modules in a remote chassis. You **cannot use I/O modules in the redundant chassis pair.**

This table describes differences in network use for I/O in redundancy systems.

Remote I/O Module Placement	Available with Redundancy System, Revision 19 and Later	Available with Redundancy System, Revision 16 or Earlier
EtherNet/IP I/O network	x	-
1715 Redundant I/O System	x	-
ControlNet network	x	x
DeviceNet® network ⁽¹⁾	x	x
Data Highway Plus™ ⁽¹⁾	x	x
Universal remote I/O ⁽¹⁾	x	x

(1) In a redundancy system, you can access remote I/O modules on this network only via a ControlNet or EtherNet/IP network bridge.

For more information on how to use remote and 1715 redundant I/O over an Ethernet network, see [I/O Placement on page 36](#) and the Redundant I/O System User Manual, publication [1715-UM001](#).

Redundancy System Operations

Once the redundancy modules in the redundant chassis pair are connected and powered, they determine which chassis is the primary chassis and which is the secondary chassis.

The redundancy modules in both the primary and secondary chassis monitor events that occur in each of the redundant chassis. If certain faults occur in the primary chassis, the redundancy modules execute a **switchover** to the unfaulted, secondary chassis.

System Qualification and Synchronization

When the redundant system is first started, the redundancy modules run checks on the redundant chassis. These checks determine if the chassis contain the appropriate modules and firmware to establish a redundant system. This stage of checks is referred to as **qualification**.

After the redundancy modules complete qualification, synchronization can take place. **Synchronization** is a state in which the redundancy modules execute these tasks:

- Verify that the connection between redundancy modules is ready to facilitate a switchover
- Verify that the redundant chassis continue to meet qualification requirements
- Synchronize the data between the redundant controllers, also called **crossloading**

This data is crossloaded:

- Updated tag values
- Force values
- Online edits
- Other project information

Synchronization always takes place immediately following qualification. Also, depending on your system configuration, synchronization takes place at the end of each program that is run within the controller project, or at other intervals that you specify.

Switchovers

During redundant system operation, if certain conditions occur on the primary chassis, primary control is switched to the secondary chassis. These conditions cause a switchover:

- Loss of power
- Major fault on the controller
- Removal or insertion of any module
- Failure of any module
- Damage to a ControlNet cable or tap - This event only causes a switchover if it results in the ControlNet communication module transition to a lonely state, that is, the module does not see any devices on the network.
- Loss of an EtherNet/IP connection - This event only causes a switchover if it results in the EtherNet/IP communication module transition to a lonely state, that is, the module does not see any devices on the network.
- A program-prompted command to switchover
- A command that is issued via the Redundancy Module Configuration Tool (RMCT)

After a switchover occurs, the new primary controller continues to execute programs, which begin with the highest-priority task that had been executing on the previous primary controller.

For more information about how tasks execute after a switchover, see [Crossloads, Synchronization, and Switchovers on page 113](#).

Your application can require some programming considerations and potential changes to accommodate a switchover. For more information on these considerations, see [Chapter 7, Program the Redundant Controller on page 109](#).

IMPORTANT During a switchover of the fiber channels of the 1756-RM2/A module, scan time encounters a delay of ~10 ms; however, the chassis always remains synched.

HMI Blind Time Reduction During a Switchover

HMI Blind Time is the time during a switchover from primary to secondary, when tag data from the controller is unavailable for reading or writing. HMI Blind Time is associated with visualizing process operations from an HMI. However, HMI Blind Time is applicable to any software that uses tag data, such as data loggers, alarming systems, or historians. HMI Blind Time reduction is important to increase the availability of the HMI system.

Brief communication interruption occurs between FactoryTalk Linx software and the redundant chassis pair when a switchover occurs. After the switchover is complete, communication resumes automatically.

-
- IMPORTANT**
- Prior to firmware revision 30.051, the communication delays apply only when communication is exclusively over EtherNet/IP networks.
 - With firmware revision 30.051 or later, the communication delays apply to both EtherNet/IP and ControlNet networks.
-

The time between the communication (updating active data) interruption and the restoration (resumes updates) is often referred to as ‘HMI Blind Time.’

-
- IMPORTANT** FactoryTalk Linx software is part of FactoryTalk Services, which has been releasing a series of Service Releases (SRs) that are backward compatible with any CPR 9 products. Existing and new users who are using FactoryTalk View version 5.0 (CPR9) or later can use the HMI Blind Time feature.
-

As of revision 31.052, the communication delays over Ethernet during a switchover event have been reduced significantly. The following are required to take advantage of this:

- A dedicated pair of ControlLogix Communication Modules (1756-EN2TP, 1756-EN2TR, 1756-EN2T), that do not swap IP addresses
- ControlLogix 5570 redundancy controllers with redundancy firmware revision 31.052 or later
- FactoryTalk Linx 6.00 with the FactoryTalk Linx patch available from Rockwell Automation Knowledgebase Answer ID 1073788, or later versions of FactoryTalk Linx.

The patch is available at <https://rockwellautomation.custhelp.com/>

- Redundant ControlLogix Controller shortcut type in FactoryTalk Linx that points to the Primary and Secondary controllers through the communication modules, without swapping IP addresses. For information on shortcuts in FactoryTalk Linx, see the FactoryTalk Linx Getting Results Guide, publication [LNXENT-GR001](#).

Some communication delays can occur during qualification. The existence and duration of these delays depend on:

- Quantity and types of tags on scan in FactoryTalk Linx software
- Client screen and tag update rates (e.g. FactoryTalk Live Data/FactoryTalk Historian)
- Number of data subscribers (i.e. FactoryTalk Alarms and Events, FactoryTalk Batch)
- Size of the application in the redundant controller
- Controller loading, which includes the following:
 - Number of tasks and scan rates (assumes no continuous task)
 - Number of programs
 - Memory usage
 - Null task percentage available
 - Network traffic

Restrictions

There are restrictions that you must consider when using a redundancy system. Most of these restrictions apply to all redundancy system revisions. Exceptions are noted:

- See the release notes of the redundancy bundles for compatible products, versions, and revisions
- The redundant controller program cannot contain these tasks:
 - Event tasks
 - Inhibited tasks

For recommendations and requirements that are related to programming the redundant controller, see [Program the Redundant Controller on page 109](#).

- You cannot use the Match Project to Controller feature available in Studio 5000 Logix Designer® in a redundancy system.
- You cannot use program motion in a redundant controller program.
- You cannot use consumed Unicast connections in a redundancy system. If you attempt to use consumed Unicast connections, disqualification occurs and qualification of an unsynchronized redundant chassis pair is not allowed. You can use produced Unicast connections that remote consumers consume.
- You can use a maximum of two controllers and seven ControlNet or EtherNet/IP communication modules in each chassis of a redundant chassis pair.

You can execute the tasks that were supported previously in a redundancy system, revision 19.052 or greater.

This graphic shows an example ControlLogix redundancy system, revision 19.053 or greater, which uses EtherNet/IP networks.

Figure 1 - Example ControlLogix Redundancy System, Revision 19.053 or greater, using an EtherNet/IP Network

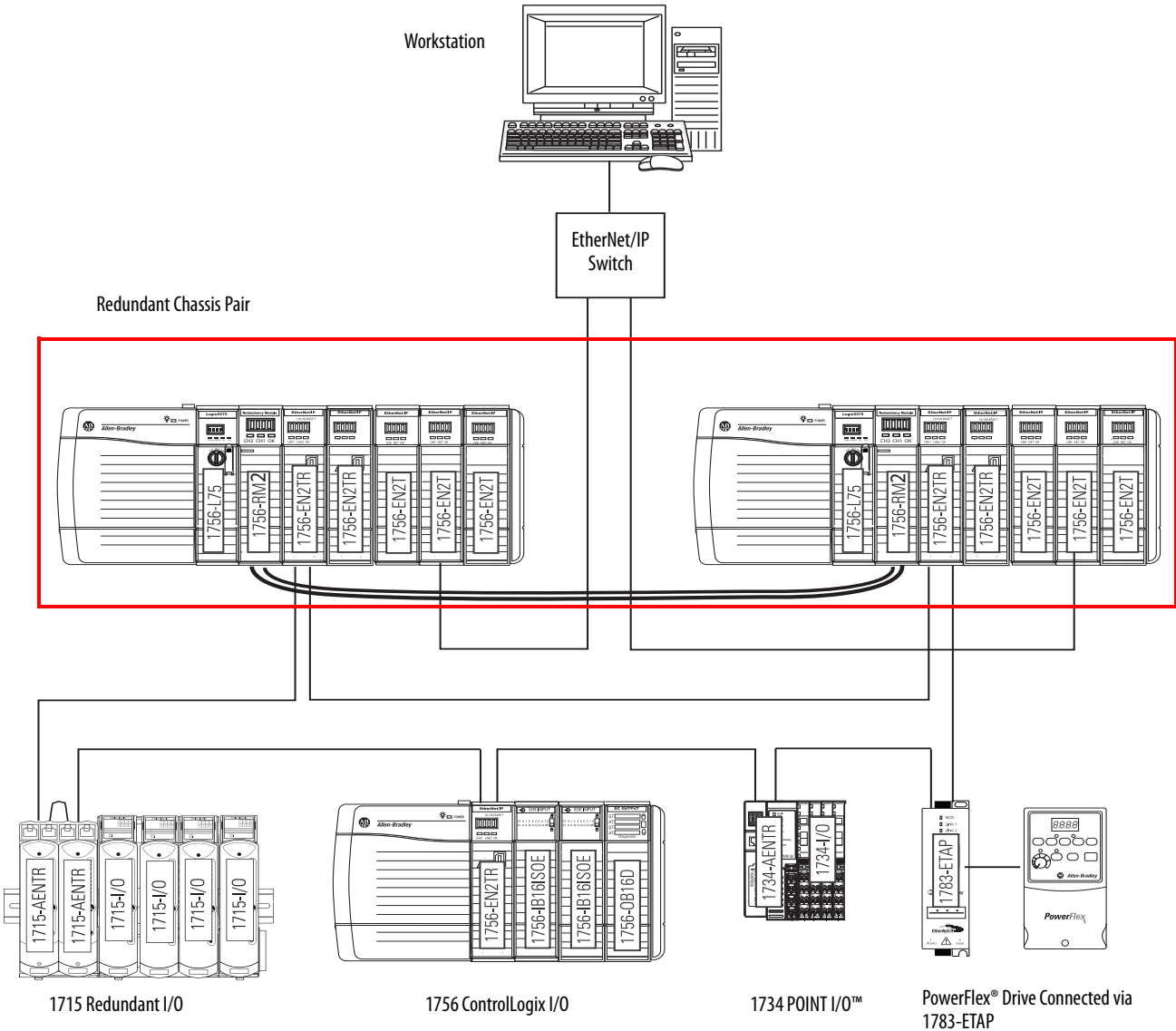

Notes:

Design a ControlLogix Redundancy System

Topic	Page
Redundant Chassis	21
Controllers in Redundant Chassis	22
EtherNet/IP Networks with Redundant Systems	28
ControlNet Networks with Redundant Systems	30
Other Communication Networks	34
I/O Placement	36
Using HMI	38
Optional Software	41

This chapter explains how to use the required and optional components to design a redundancy system.

IMPORTANT There are module series level, firmware revision, and software version requirements for redundancy systems. For more information on these module series level, firmware revision, and version requirements, see the current release notes at: <http://www.rockwellautomation.com/global/literature-library/overview.page>

Redundant Chassis

You can use any ControlLogix® or ControlLogix-XT™ chassis in a redundant chassis pair as long as the two chassis that are used are the same size. For example, if the primary chassis in your redundant chassis pair uses a 1756-A4 chassis, the secondary chassis must use a 1756-A4 chassis.

TIP When using 1756-L72, 1756-L73, 1756-L74, or 1756-L75 Redundant controllers in your system, you must use firmware revision 19.053 or greater. When using a 1756-L71 Redundant controller, you must use firmware 20.054 or greater.

Redundant Chassis Configuration Requirements

These configuration parameters must match for the components in a redundant chassis pair during normal system operation:

- Module type
- Chassis size
- Slot placement
- Firmware revision
- Series level. See [page 25](#)

Figure 2 - Example of Redundant Chassis Pair

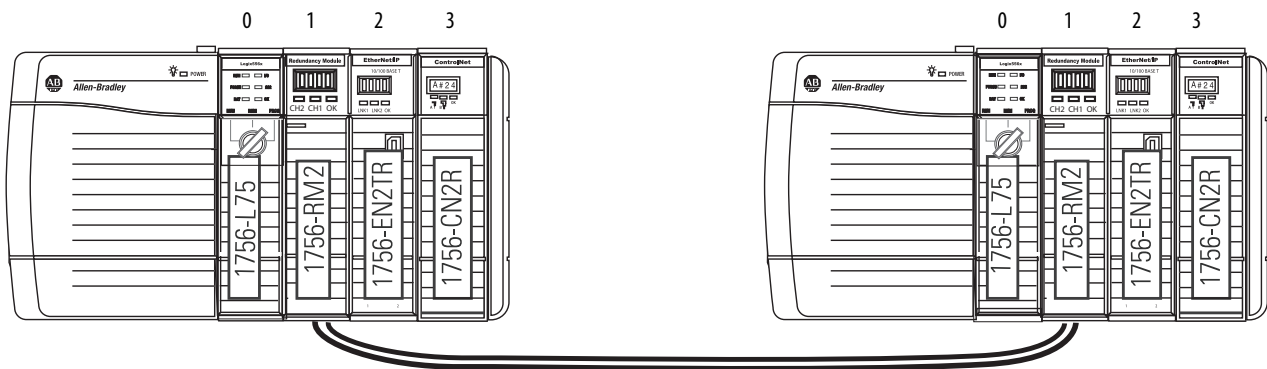

Controllers in Redundant Chassis

Remember these points when you place controllers in the redundant chassis pair:

- Controllers are typically included, but not required, in redundancy systems. If you have a redundancy system without controllers, you have only a redundant gateway rack.
- You can place up to two controllers in the same chassis. When you use two controllers in the same chassis, they must be of the same product family. The series of the controller in the primary and secondary chassis do not need to match.

For example, you cannot place a ControlLogix 5560 controller and a ControlLogix 5570 controller in the same chassis.

IMPORTANT When using a ControlLogix redundancy system, revision 16.081 or earlier, you cannot use two 1756-L64 controllers in the same chassis. You can, however, use a 1756-L64 controller in the same chassis as a 1756-L61, 1756-L62, or 1756-L63 controller.

- You can use different catalog numbers from the same product family in the same chassis. For example, you can use two ControlLogix 5560 controllers in a chassis.
- Each controller must have enough data memory to store twice the amount of tag data that is associated with a redundant controller project.
- Each controller must have enough I/O memory to store twice the amount of I/O memory used. To check the I/O memory that is used and available, access the Memory tab of the Controller Properties dialog box in the programming software.

For more information about data and I/O memory, see Knowledgebase Answer ID 28972, accessible at:

<https://rockwellautomation.custhelp.com>.

A login is required to access the article.

- When you use the redundancy system update (RSU) feature to update a redundancy system while the system continues operation, the updated secondary controllers must provide the same or greater memory than the primary controllers.

A secondary controller provides greater memory than the primary controller if it is a higher catalog number, for example, a 1756-L63 primary controller and a 1756-L65 secondary controller.

This table describes the secondary controllers to which you can upgrade, based on the primary controller that is used, when using RSU.

Differences in controller types between chassis can exist only during the system upgrade process. When you complete the system upgrade, the controllers in the redundant chassis pair **must match** for the system to synchronize.

Plan for Controller Connections

Consider these conditions when you plan controller connection use:

- **ControlLogix 5560 controllers provide 250 total connections.**
- **ControlLogix 5570 controllers provide 500 total connections.**

If you use the redundant controller at, or very near the connection limits, you can experience difficulty synchronizing your chassis.

Redundancy Modules in Redundant Chassis

Two redundancy modules, one in each chassis of the redundant chassis pair, jointly supervise the control system operating states and transitions, which establishes the framework for system redundancy. This bridge between chassis facilitates the exchange of control data and synchronization of operations.

The redundancy modules let you commission the redundant system in a plug-and-play manner without any programming. You connect a redundancy module pair with the default configuration in the redundant chassis pair and configure the redundant system.

You can establish redundancy between chassis in either of these manners:

- Insert a redundancy module pair into two powered chassis that contain redundancy-compliant components and redundancy-enabled application programs, and then connect the redundancy modules.
- Insert and connect the redundancy modules in two chassis and then insert redundancy-compliant components into each chassis.

IMPORTANT You are not required to develop any programming to migrate from a non-redundant to a redundancy system if your application meets these conditions:

- Your application meets the points that are listed in [Restrictions on page 18](#).
- The controller properties dialog box in your project has Redundancy enabled.

Once the redundant chassis pair contains all desired components and is powered, no further tasks are required in the redundancy modules to activate system redundancy. The redundancy modules automatically determine the operational state of each of the chassis pair and are ready to accept commands and provide system monitoring.

Communication Modules in Redundant Chassis

Remember these points when placing ControlLogix ControlNet® and EtherNet/IP™ communication modules in the redundant chassis pair:

- You must use enhanced communication modules in redundancy systems. Enhanced communication modules contain a '2' in their catalog number. For example, the 1756-EN2T module.

Standard ControlNet and EtherNet/IP communication modules are not supported.

- You can use the **1756-EN2TR module** only with a redundancy system, **revision 19.052** or later.
- You can use the **1756-EN2TP module** only with a redundancy system, **revision 31.052** or later.
- You can use any combination of up to seven enhanced communication modules in each redundant chassis.
- If you use a ControlNet network in your redundant chassis pair, you must have two ControlNet communication modules outside the redundant chassis pair. When you assign node address numbers, assign the lowest node number address to a ControlNet communication module outside the redundant chassis pair.

For more information, see [Use at Least Four ControlNet Network Nodes on page 30](#) through [Assign Lowest Node Numbers to Remote ControlNet Modules on page 31](#).

- You cannot use Series A ControlNet communication modules in a redundancy system.
- The Series for EtherNet/IP communication modules is not required to match in a partnered set. However, the firmware levels must be the same in a partnered set. Also, if your application requires a feature specific to a module series level, you must use the same series level for each module in a partnered set.

For example, only the 1756-EN2T/C communication module only offers the double-data rate (DDR) feature. You must use 1756-EN2T/C modules in each chassis of the redundant chassis pair to use DDR.

- **Do not use the USB ports** of communication modules to access the redundant system network while the system is running, that is, online. Use of the USB ports while online can result in a loss of communication after a switchover.

Plan for Communication Module Connections

A CIP™ connection is a point-to-point communication mechanism that is used to transfer data between a producer and a consumer. These mechanisms are examples of CIP connections:

- Logix 5000™ controller message transfer to Logix 5000 controller
- I/O or produced tag
- Program upload
- RSLinx® DDE/OPC client
- PanelView™ polling of a Logix 5000 controller

ControlLogix **ControlNet communication modules** provide 131 total CIP connections. Consider these points when using CIP connections with ControlLogix ControlNet communication modules:

- Three of the 131 CIP connections are reserved for redundancy. The three redundant-system CIP connections always appear to be in use, even when no connections are open.
- You can use the remaining 128 CIP connections in any manner that your application requires, such as the examples listed previously.

ControlLogix **EtherNet/IP communication modules** provide 259 total CIP connections. Consider these points when using CIP connections with ControlLogix EtherNet/IP communication modules:

- Three of the 259 CIP connections are reserved for redundancy.
- You can use the remaining 256 connections in any manner that your application requires, such as the examples listed previously.

Power Supplies and Redundant Power Supplies in Redundancy Systems

Typically, redundancy systems use standard power supplies. You can choose to use redundant power supplies to maintain power to a ControlLogix chassis if one of the supplies loses power. Use these hardware components to connect redundant power supplies:

- Two redundant power supplies for each chassis
- One 1756-PSCA chassis adapter for each redundant chassis
- Two 1756-CPR cables for each redundant chassis to connect the power supplies to the 1756-PSCA adapter
- Optional, user-supplied annunciator wiring to connect the power supplies to remote input modules

Figure 3 - Redundant Power Supplies with Redundant Chassis

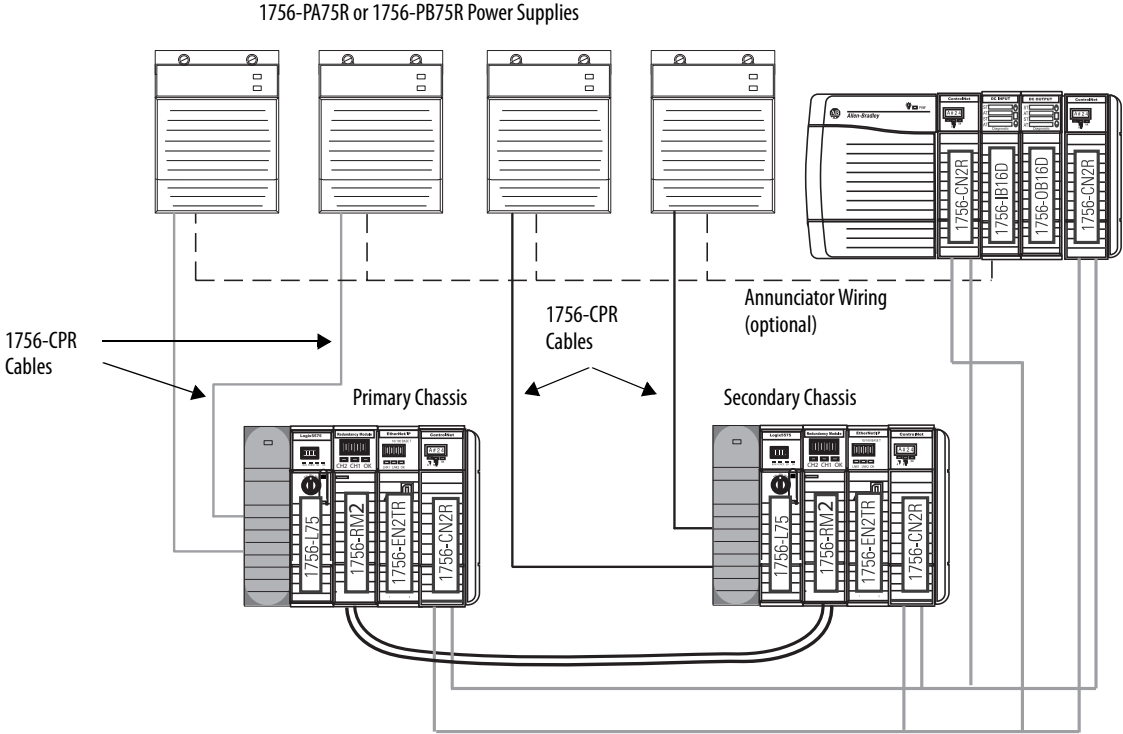

For more information about redundant power supplies, see the ControlLogix System Selection Guide, publication [1756-SG001](#).

EtherNet/IP Networks with Redundant Systems

The use of EtherNet/IP networks in a redundancy system is primarily dependent on your system revision.

IMPORTANT A remote chassis can be accessed over an EtherNet/IP network by using any EtherNet/IP module that works in a non-redundant chassis with no additional firmware requirement with the following exception. If the remote chassis contains a controller that consumes a tag that is produced in the redundant chassis pair, it can only consume the tag with the required firmware revisions.

For more information on how to use an EtherNet/IP network in your redundancy system, see [Chapter 5, Configure the ControlNet Network on page 77](#).

Unicast Functionality

Redundancy systems support unicast produced tags. Unicast consumed tags are **not supported** in redundancy systems. Unicast I/O is not supported in a redundancy system.

Possible Communication Delays on EtherNet/IP and ControlNet Networks

The connection between a component and the redundant chassis pair can experience brief communication delays during a switchover. After the switchover is complete, communication resumes automatically.

These connection types can experience the communication delay when the switchover occurs:

- HMI to redundant chassis pair
- FactoryTalk® Batch server to redundant chassis pair
- FactoryTalk Alarms and Events Service to redundant chassis pair

IMPORTANT

- Prior to firmware revision 30.051, the communication delays apply only when communication is exclusively over EtherNet/IP networks.
- With firmware revision 30.051 or later, the communication delays apply to both EtherNet/IP and ControlNet networks.

Bridge from an EtherNet/IP Network to a ControlNet Network

Bridge from an EtherNet/IP network to a ControlNet network if you must maintain the connection between the component and a redundant chassis pair during a switchover.

IMPORTANT You can bridge from an EtherNet/IP network to a ControlNet network to maintain the connection between the component and a redundant chassis only in redundancy firmware revisions prior to revision 30.051.

See [HMI Blind Time Reduction During a Switchover on page 17](#).

This example graphic shows the recommended method to connect an HMI to a redundant chassis pair if connection drops are a concern in your application. In this graphic, the remote chassis contains I/O modules and the EtherNet/IP and ControlNet communication modules. The I/O modules are not required and are shown for example Minimize only.

Figure 4 - Configuration Used to Eliminate Communication Delays on Switchover

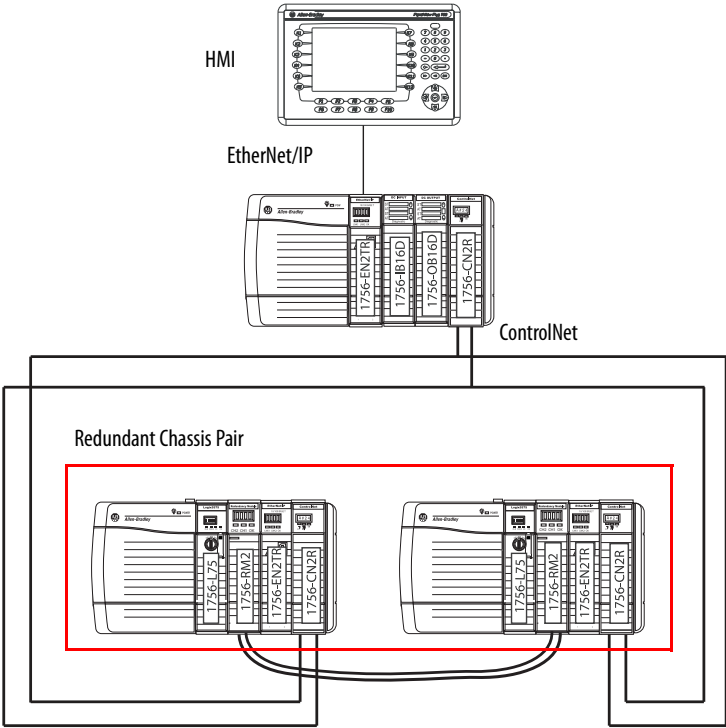

ControlNet Networks with Redundant Systems

ControlNet networks are used to connect redundant control chassis to remote I/O and to other devices in the system.

IMPORTANT A remote chassis can be accessed over a ControlNet network that uses any ControlNet module that works in a non-redundant chassis with no additional firmware requirement.

ControlNet Network Requirements

If you use a ControlNet network in your redundancy system, you must consider the following when using ControlNet networks in your redundancy system:

- [Use at Least Four ControlNet Network Nodes](#)
- [Assign Lowest Node Numbers to Remote ControlNet Modules](#)
- [Set Partnered ControlNet Module Switches to the Same Address](#)
- [Reserve Consecutive Node Addresses for Partner Modules](#)

Use at Least Four ControlNet Network Nodes

With redundant systems, at least four ControlNet network nodes are required. This configuration is required because two or more ControlNet nodes must be used with the two ControlNet modules that are used in the redundant chassis. One of the two nodes outside of the redundant chassis must be at a lower node address than the ControlNet modules in the redundant chassis.

If your ControlNet uses fewer than four nodes, and a switchover occurs, connections can drop and outputs connected to that node can change state during the switchover.

You can include these ControlNet modules and redundant ControlNet nodes:

- ControlNet bridges in remote chassis
- Any other ControlNet devices on the ControlNet network
- A workstation running RSLinx Classic communication software that is connected via a ControlNet network

Assign Lowest Node Numbers to Remote ControlNet Modules

Do not assign the lowest ControlNet node addresses to ControlNet modules in the redundant chassis pair.

If you assign the lowest ControlNet node addresses to ControlNet modules in the redundant chassis pair, you can experience these system behaviors:

- Upon a switchover, you can lose communication with I/O modules, produced tags, and consumed tags.
- If you remove a ControlNet module from the redundant chassis, it can result in lost communication with I/O modules, produced tags, and consumed tags.
- If the entire system loses power, you can be required to cycle power to the primary chassis to restore communication.

Set Partnered ControlNet Module Switches to the Same Address

Where ControlNet modules are used as partners in a redundant chassis pair, you must set the node address switches to the same node address. The primary ControlNet modules can be at even or odd node addresses.

For example, if partnered ControlNet modules are assigned to nodes 12 and 13 of the ControlNet network, set the node address switches of the modules to the same address of 12.

Figure 5 - Example of Switch Address for Partnered ControlNet Modules

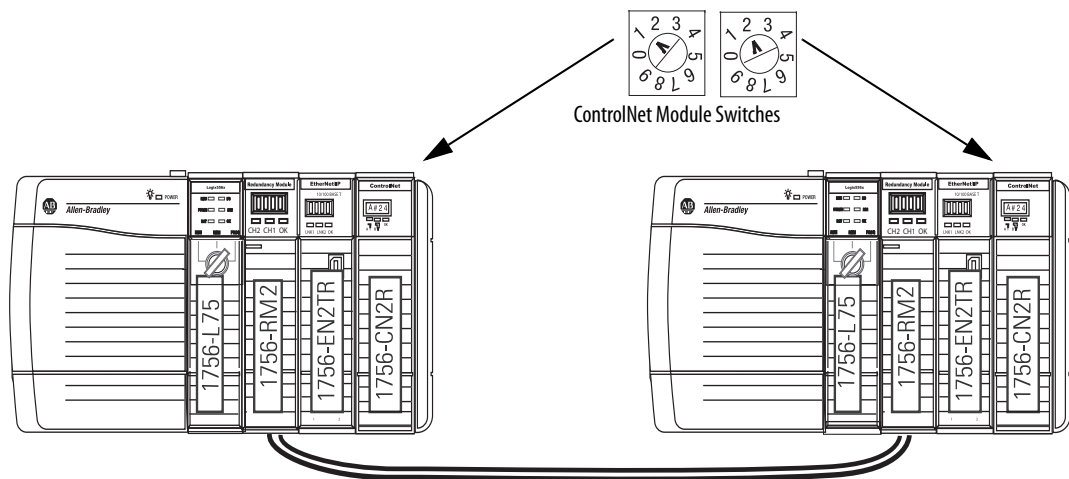

Reserve Consecutive Node Addresses for Partner Modules

Where ControlNet modules are used as partners in redundant chassis, plan consecutive node numbers for those partnered modules. Plan for consecutive node addresses because the redundant system automatically assigns the consecutive node address to the secondary ControlNet module.

For example, partnered ControlNet modules with address switches set at 12 are assigned ControlNet node numbers 12 and 13 by the system.

TIP The primary chassis always assumes the lower of the two node addresses.

Figure 6 - Example of Redundant ControlNet Modules at Consecutive Addresses

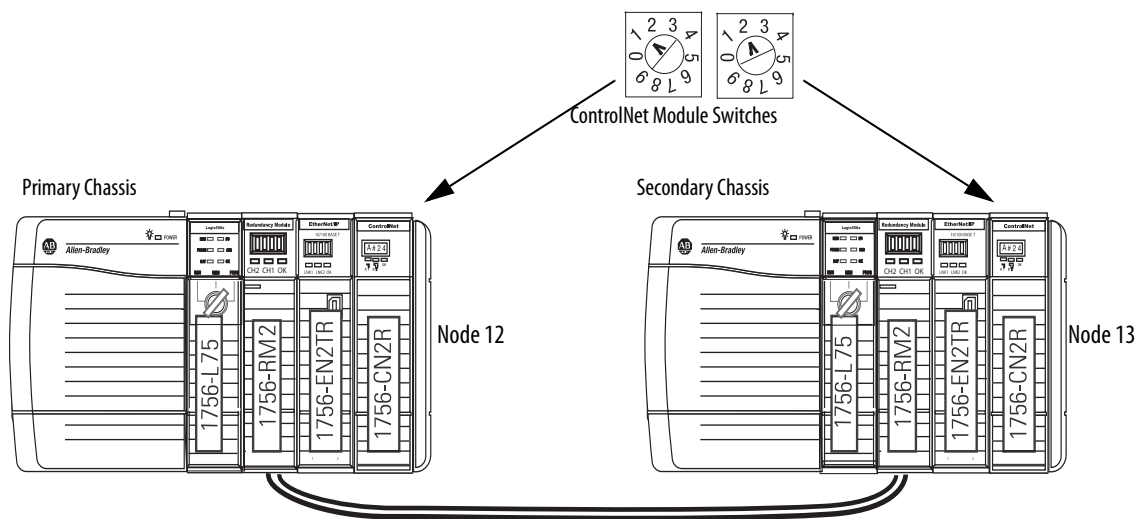

Redundant ControlNet Media

The use of redundant ControlNet media helps to prevent a loss of communication if a trunkline or tap is severed or disconnected. A system that uses redundant ControlNet media uses these components:

- 1756-CN2R, series B or later, communication modules in each redundant chassis
- ControlNet modules that are designed for redundant media at each ControlNet node on the network
- Redundant trunk cabling
- Redundant tap connections for each ControlNet module connected

Figure 7 - Redundant ControlNet Media with Redundant ControlLogix Chassis

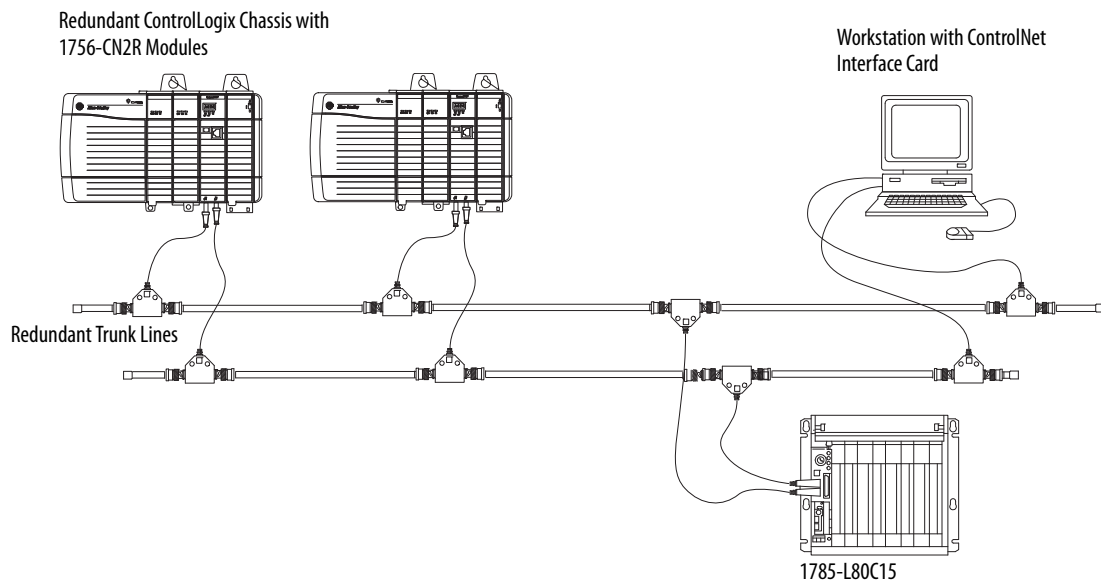

Other Communication Networks

You can use only EtherNet/IP and ControlNet networks, and corresponding modules, in redundancy systems.

IMPORTANT Do not use the redundant chassis to bridge between networks. Bridging through the redundant chassis to the same or different networks, or routing messages through redundant chassis is not supported.

You can bridge to other communication networks outside of the redundant chassis. For example, you can bridge to a universal remote I/O network via a remote chassis.

Figure 8 - Example of Bridging to Remote I/O on Various Networks

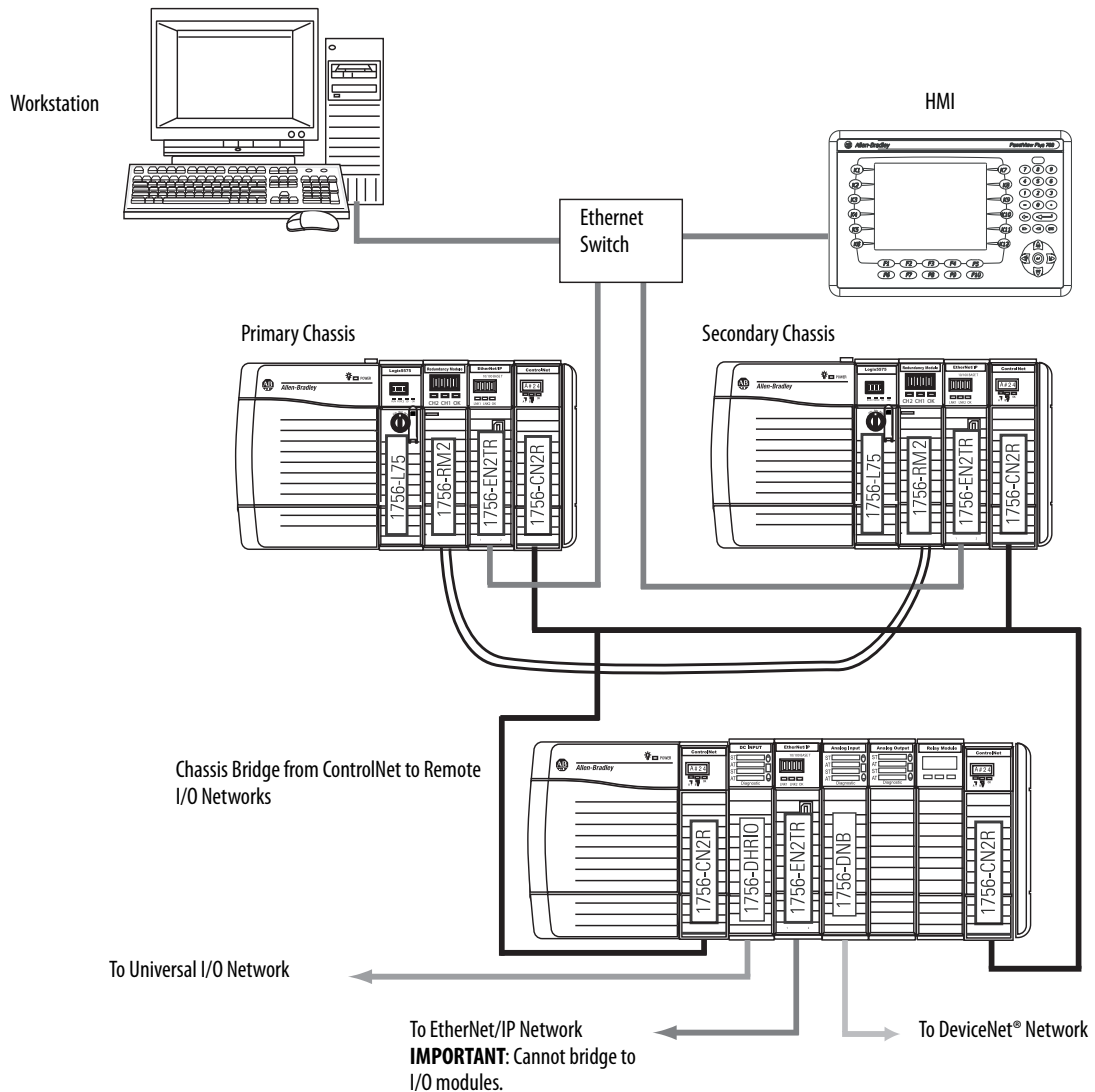

You can bridge these networks via a remote chassis:

- ControlNet
- DeviceNet
- EtherNet/IP
- Universal remote I/O
- Data Highway Plus™

This table indicates what system components to use with each network that is connected to a redundant system.

Table 2 - Communication Networks Available for Use with Redundancy Systems

Network	Connection to Redundant System	Component	
		I/O	HMI
ControlNet	Directly to redundant chassis	Yes	Yes
	Via a bridge	No	Yes
DeviceNet	Via a bridge	Yes	Yes
EtherNet/IP	Directly to redundant chassis	Yes - Redundancy System, Revision 19.052 or later	Yes ⁽¹⁾
	Via a bridge	No	Yes
Universal remote I/O	Via a bridge	Yes	Yes
Data Highway Plus	Via a bridge	Yes	Yes

(1) Prior to redundancy firmware revision 30.051, you can connect the HMI to the redundant chassis pair via a bridge from an EtherNet/IP network to a ControlNet network to help prevent a brief loss of communication with the redundant chassis pair if a switchover occurs. For more information, see [Possible Communication Delays on EtherNet/IP and ControlNet Networks on page 28](#).

I/O Placement

In a redundancy system, you can place I/O modules in these locations:

- Same ControlNet network as redundant controllers and communication modules
- Same EtherNet/IP network as redundant controllers and communication modules
- DeviceNet network that is connected via a bridge
- Universal remote I/O network that is connected via a bridge

IMPORTANT You **cannot** install I/O modules in the redundant chassis pair. You can only install I/O modules in remote locations that are accessed over the networks in this list.

You can connect to remote I/O modules over an EtherNet/IP network in a redundancy system, **revision 19.052 or later**.

1715 Redundant I/O Systems

With a redundancy system revision 19.052 or greater, you can connect to 1715 Redundant I/O systems over an EtherNet/IP network.

The 1715 Redundant I/O system lets a controller communicate to a remote, redundant I/O chassis over an EtherNet/IP network. The 1715 Redundant I/O system provides high availability and redundancy for critical processes by using a redundant adapter pair and multiple I/O modules that have diagnostics and are easily replaceable.

The 1715 Redundant I/O system consists of one, two-slot, adapter base unit that houses a redundant adapter pair. The adapter base unit is connected to up to 8, three-slot, I/O base units, which can hold up to 24 fully configurable digital and analog I/O modules. You can configure a 1715 Redundant I/O system in a Ring or Star topology.

Each 1715 Redundant I/O system uses one IP address as the primary IP address for all communication. The redundant adapter pair consists of two active modules, a primary adapter and its partner, a secondary module.

Figure 9 - Example of I/O Placement Options

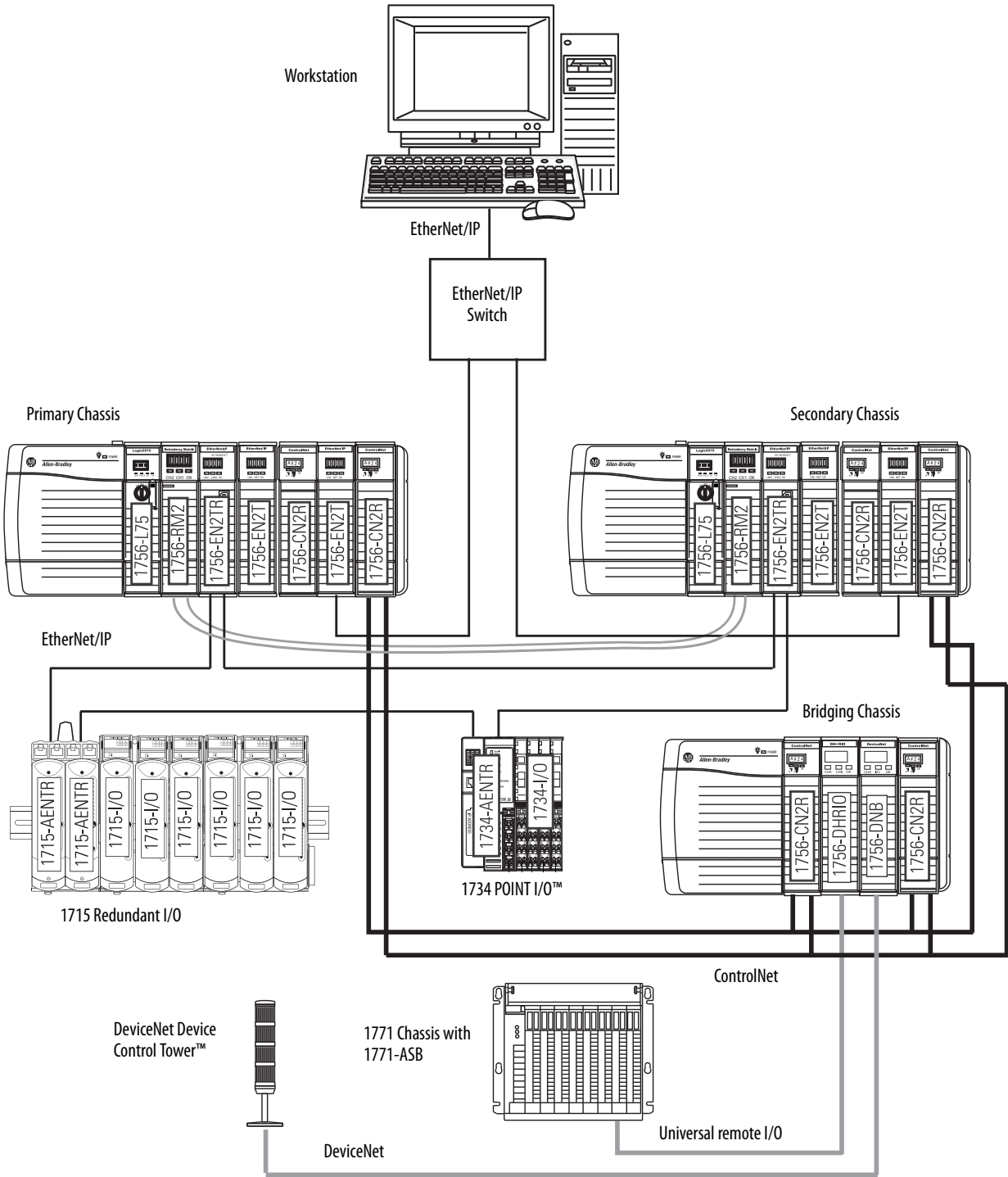

Using HMI

Depending on the network that is used to connect the redundant system to HMIs, plan for certain placement and configuration requirements. You can connect an HMI to a primary chassis over either of these networks:

- EtherNet/IP
- ControlNet

HMI Connected Via an EtherNet/IP Network

This table describes redundant system considerations specific to the HMI being used on the EtherNet/IP network.

Type of HMI Used	Considerations						
PanelView Standard terminal	Same as a non-redundant system.						
<ul style="list-style-type: none"> • PanelView Plus terminal • VersaView® industrial computer that runs the Windows CE operating system 	<ul style="list-style-type: none"> • Use FactoryTalk Linx software, version 5.0 or later. • Set aside connections for each PanelView Plus or VersaView CE terminal as indicated in this table. <table border="1" style="margin-left: auto; margin-right: auto;"> <thead> <tr> <th>In this module</th> <th>Reserve</th> </tr> </thead> <tbody> <tr> <td>Controller</td> <td>5 connections</td> </tr> <tr> <td>1756-EN2T</td> <td>5 connections</td> </tr> </tbody> </table>	In this module	Reserve	Controller	5 connections	1756-EN2T	5 connections
In this module	Reserve						
Controller	5 connections						
1756-EN2T	5 connections						
FactoryTalk View Supervisory Edition software with FactoryTalk Linx software	<ul style="list-style-type: none"> • Use FactoryTalk Linx communication software, version 5.0 or later. • Keep the HMI and both redundant chassis on the same subnet. • Configure the network to use IP swapping. 						
<ul style="list-style-type: none"> • FactoryTalk View Supervisory Edition software with RSLinx Classic software, version 2.52 or later • RSView®32 software • Any other HMI client software that uses RSLinx Classic software, version 2.52 or later 	Limit the number of RSLinx servers that a controller uses to 1...3 servers, where the use of one server is ideal.						

HMI connected to a redundant chassis pair exclusively over an EtherNet/IP network can briefly drop the connection when a switchover occurs. The connection is re-established, however, after the switchover is complete.

HMI Connected Via a ControlNet Network

This table describes redundant system considerations specific to the HMI being used on the ControlNet network.

Type of HMI Used	Considerations						
<ul style="list-style-type: none"> PanelView Standard terminal PanelView 1000e or PanelView 1400e terminal 	<ul style="list-style-type: none"> If your HMI communicates via unscheduled communication, use four terminals per controller. If your HMI does not communicate via unscheduled communication, use the number of terminals that are required for your application. 						
<ul style="list-style-type: none"> PanelView Plus terminal VersaView industrial computer that runs the Windows CE operating system 	Set aside connections for each PanelView Plus or VersaView CE terminal. <table border="1" style="margin-left: auto; margin-right: auto;"> <thead> <tr> <th>In this module</th> <th>Reserve</th> </tr> </thead> <tbody> <tr> <td>Controller</td> <td>5 connections</td> </tr> <tr> <td>1756-CN2⁽¹⁾ 1756-CN2R⁽¹⁾</td> <td>5 connections</td> </tr> </tbody> </table> <p>(1) You can use series B or later modules.</p>	In this module	Reserve	Controller	5 connections	1756-CN2 ⁽¹⁾ 1756-CN2R ⁽¹⁾	5 connections
In this module	Reserve						
Controller	5 connections						
1756-CN2 ⁽¹⁾ 1756-CN2R ⁽¹⁾	5 connections						
<ul style="list-style-type: none"> FactoryTalk View Supervisory Edition software with RSLinx Classic software, version 2.52 or later RSView32 software Any other HMI client software that uses RSLinx Classic software, version 2.52 or later 	Limit the number of RSLinx servers that a controller uses to 1 (ideal) to 3 (maximum).						

For redundancy firmware revisions earlier than revision 30.051, an HMI connected to a primary chassis exclusively over a ControlNet network or bridge from an EtherNet/IP network to a ControlNet network maintains its connections during a switchover.

For redundancy firmware revisions 30.051 or later, HMI connections are no longer maintained on switchover with communications over ControlNet. After the switchover is complete, the connection is re-established. This causes a Batch server to go to a held state.

Figure 10 shows an example of how to connect an HMI to a primary controller over a ControlNet network.

Figure 10 - Connection from HMI Over a ControlNet Network

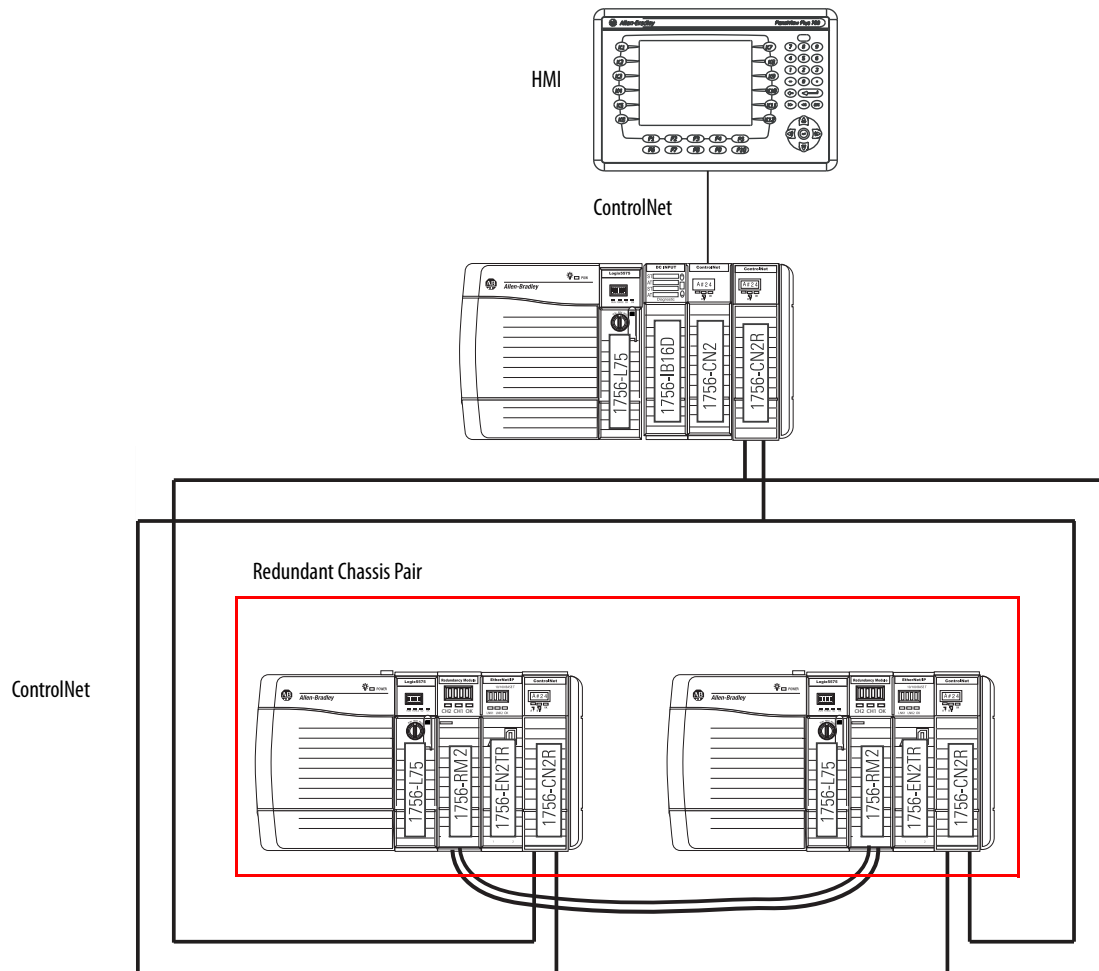

For an example of how to connect an HMI to a redundant chassis pair over a path that bridges from an EtherNet/IP network to a ControlNet network, see [Bridge from an EtherNet/IP Network to a ControlNet Network on page 29](#).

Optional Software

Optional software can be needed depending on your redundancy system program, configuration, and components. Optional software is listed in the following table.

If using	Then use this software
ControlNet network	RSNetWorx™ for ControlNet
EtherNet/IP network	RSNetWorx for EtherNet/IP
Alarms	FactoryTalk Alarms and Events
Batches or recipes	FactoryTalk Batch
HMI ⁽¹⁾	<ul style="list-style-type: none">• FactoryTalk View Site Edition• FactoryTalk View Machine Edition• FactoryTalk Linx software• RSVIEW32
Various FactoryTalk services	FactoryTalk Services Platform

(1) See [Using HMI on page 38](#) for additional information.

Notes:

Install the Redundancy System

Topic	Page
Before You Begin	43
Redundancy System Quick Start	43
Install the Hardware	45
Connect the Redundancy Modules	52
Update Redundant Firmware	58
Designate the Primary and Secondary Chassis	61

Before You Begin

Complete these tasks before you install the redundancy system:

- Verify that you have the components that are required to install your system.
- Read and understand the safety and environmental considerations explained in the installation instruction publication for each component.
- Order a 1756-RMCx fiber-optic communication cable if you do not have one.
- If you choose to make your own fiber-optic cable for lengths that the 1756-RMCx catalog numbers do not support, refer to [Fiber-optic Cable on page 56](#).

Redundancy System Quick Start

See these Quick Start steps when configuring your system for the first time.

1. Review the release notes for the firmware bundle that you are installing. Make sure that you have compatible hardware and the correct firmware revisions.
2. Install/update the workstation software and firmware bundle.
Software applications that are needed include:
 - Studio 5000 Logix Designer® application
 - RSLinx® Classic communication software
 - Redundancy Module Configuration Tool (RMCT). See [Install the Hardware on page 45](#)

IMPORTANT If RSLinx Classic software is already on your system, make sure to shut it down before installing/upgrading software.

3. To begin the hardware installation, determine the location of your modules in the chassis of the system. Plug in the communication modules, controller, and redundancy modules into the chassis, matching partners slot for slot.

Install the following:

- The first chassis and power supply, see [page 45](#).
 - The first chassis communication modules.
 - a. Determine the IP address for your Ethernet communication modules.

Both Ethernet communication modules of the same pair have the same IP address.
 - b. Set both Ethernet communication modules to the same IP address. (This rule also applies to ControlNet® networks.) See [Configure the EtherNet/IP Network on page 65](#).
 - The first chassis controller.
 - The first chassis redundancy module, see [page 46](#).
 - The second chassis, power supply, communication modules, controller, and redundancy module. See [page 52](#).
4. Plug in the fiber-optic communication cable to connect the redundancy modules in both chassis. See [Connect the Redundancy Modules on page 52](#).
 5. Upgrade the firmware of the redundant chassis modules. See [Update Redundant Firmware on page 58](#).
 - a. Update the firmware to the modules in the first chassis.
 - b. Apply power to the first chassis.
 - c. Launch ControlFLASH™ software and upgrade the firmware.
 - d. Upgrade the firmware of the redundancy module and verify that the status is PRIM.
 - e. Update all remaining modules in the chassis using ControlFLASH software.
 - f. Power off the first chassis.
 - g. Power on the second chassis.
 - h. Follow the same update process as the first chassis.
 - i. Power off the second chassis.
 6. Designate the primary chassis. See [Designate the Primary and Secondary Chassis on page 61](#).
 - a. Verify that power is removed from both chassis.
 - b. Apply power to the chassis you want designated as the primary. Wait for the status indicator to display PRIM.
 - c. Apply power to the chassis you want designated as the secondary.

Install the Hardware

Follow these steps to configure and install the hardware components of your system.

Install the First Chassis

When you install a redundancy system, install one chassis, and its necessary components, at a time.

Module Placement and Partnering

Each pair of controllers and communication modules must be composed of compatible partner modules. Two modules in the same slot are considered as compatible partners only if they contain compatible hardware and firmware and other rules that the module can enforce. Either the module in the primary chassis or its partner in the secondary chassis determines the compatibility status (Compatible or Incompatible).

The redundancy module pair must occupy the same slots in their respective chassis. The redundancy module pair does not consider the chassis pair to be partnered if the redundancy modules are placed in different slots. This outcome is true even if the partners of other modules are present in the same slot.

The redundancy module prevents certain redundancy operations, such as Qualification, if incompatible modules reside in the redundant-control chassis pair.

IMPORTANT For best performance, place the redundancy module in the chassis as close as possible to the controller.

Complete these tasks to install the first chassis in the redundant chassis pair:

- [Install the Redundancy Module](#)

TIP Do not apply power to the system until both chassis and their components are installed.

Then follow the steps that are described in [Update Redundant Firmware on page 58](#) to determine when to power each chassis.

Install the Redundancy Module

You must install one redundancy module in each chassis that is planned for your system. Available modules are as follows:

- 1756-RM2/A
- 1756-RM2XT
- 1756-RM/A
- 1756-RM/B
- 1756-RMXT

IMPORTANT Do not connect the primary redundancy module to the secondary redundancy module until all other components that are used in the redundant chassis pair are installed, updated to the correct firmware revision, and configured.

IMPORTANT Redundancy bundles version 24.052 and greater support only 1756-RM2 and 1756-RM2XT modules.

IMPORTANT 1756-RM2/A or 1756-RM2XT modules can only be used with other 1756-RM2/A or 1756-RM2XT modules. You cannot mix 1756-RM2/A and 1756-RM2XT modules with 1756-RM/A, 1756-RM/B, or 1756-RMXT modules.

Installation Requirements

Before you install the module, be sure to note the following:

- Understand redundant systems and redundant media
- Verify that the planned modules for each redundant chassis of the pair are identical - including firmware revisions
- Verify that your redundancy firmware revision is compatible with your planned redundant chassis modules
- The 1756-RM/B module offers a higher level of performance than a 1756-RM/A module. Both modules can coexist in a redundant system, but the highest system performance is achieved when the 1756-RM/B modules are used together when used with a ControlLogix® 5570 controller.
- The 1756-RM2/A module, when used with a ControlLogix 5570 controller, offers higher crossload speeds than the 1756-RM/B module.

Environment and Enclosure



ATTENTION: This equipment is intended for use in a Pollution Degree 2 industrial environment, in overvoltage Category II applications (as defined in IEC 60664-1), at altitudes up to 2000 m (6562 ft) without derating.

This equipment is not intended for use in residential environments and may not provide adequate protection to radio communication services in such environments.

This equipment is supplied as open-type equipment. It must be mounted within an enclosure that is suitably designed for those specific environmental conditions that will be present and appropriately designed to prevent personal injury resulting from accessibility to live parts. The enclosure must have suitable flame-retardant properties to prevent or minimize the spread of flame, complying with a flame spread rating of 5VA or be approved for the application if nonmetallic. The interior of the enclosure must be accessible only by the use of a tool. Subsequent sections of this publication may contain additional information regarding specific enclosure type ratings that are required to comply with certain product safety certifications.

In addition to this publication, see the following:

- Industrial Automation Wiring and Grounding Guidelines, Rockwell Automation publication [1770-4.1](#), for additional installation requirements
 - NEMA Standard 250 and IEC 60529, as applicable, for explanations of the degrees of protection provided by enclosure
-

Prevent Electrostatic Discharge



ATTENTION: This equipment is sensitive to electrostatic discharge, which can cause internal damage and affect normal operation. Follow these guidelines when you handle this equipment:

- Touch a grounded object to discharge potential static.
 - Wear an approved grounding wrist strap.
 - Do not touch connectors or pins on component boards.
 - Do not touch circuit components inside the equipment.
 - Use a static-safe workstation, if available.
 - Store the equipment in appropriate static-safe packaging when not in use.
-

Removal and Insertion Under Power (RIUP)



WARNING: When you insert or remove the module while backplane power is on, an electrical arc can occur. This could cause an explosion in hazardous location installations.

Be sure that power is removed or the area is nonhazardous before proceeding. Repeated electrical arcing causes excessive wear to contacts on both the module and its mating connector. Worn contacts may create electrical resistance that can affect module operation.

European Hazardous Location Approval

The following applies when the product bears the Ex Marking.

This equipment is intended for use in potentially explosive atmospheres as defined by European Union Directive 94/9/EC and has been found to comply with the Essential Health and Safety Requirements relating to the design and construction of Category 3 equipment intended for use in Zone 2 potentially explosive atmospheres, given in Annex II to this Directive.

Compliance with the Essential Health and Safety Requirements has been assured by compliance with EN 60079-15 and EN 60079-0.



ATTENTION: This equipment is not resistant to sunlight or other sources of UV radiation.



WARNING:

- This equipment must be installed in an enclosure providing at least IP54 protection when applied in Zone 2 environments.
 - This equipment shall be used within its specified ratings defined by Rockwell Automation.
 - This equipment must be used only with ATEX certified Rockwell Automation backplanes.
 - Do not disconnect equipment unless power has been removed or the area is known to be nonhazardous.
-

Safety-related Programmable Electronic Systems



ATTENTION: Personnel responsible for the application of safety-related programmable electronic systems (PES) shall be aware of the safety requirements in the application of the system and shall be trained in using the system.

Optical Ports



ATTENTION: Under certain conditions, viewing the optical port may expose the eye to hazard. When viewed under some conditions, the optical port may expose the eye beyond the maximum permissible-exposure recommendations.



Small Form-factor Pluggable



WARNING: When you insert or remove the small form-factor pluggable (SFP) optical transceiver while power is on, an electrical arc can occur. This could cause an explosion in hazardous location installations.

Be sure that power is removed or the area is nonhazardous before proceeding.

North American Hazardous Location Approval

The following information applies when operating this equipment in hazardous locations.	Informations sur l'utilisation de cet équipement en environnements dangereux.
<p>Products marked "CL I, DIV 2, GP A, B, C, D" are suitable for use in Class I Division 2 Groups A, B, C, D, Hazardous Locations and nonhazardous locations only. Each product is supplied with markings on the rating nameplate indicating the hazardous location temperature code. When combining products within a system, the most adverse temperature code (lowest "T" number) may be used to help determine the overall temperature code of the system. Combinations of equipment in your system are subject to investigation by the local Authority Having Jurisdiction at the time of installation.</p>	<p>Les produits marqués "CL I, DIV 2, GP A, B, C, D" ne conviennent qu'à une utilisation en environnements de Classe I Division 2 Groupes A, B, C, D dangereux et non dangereux. Chaque produit est livré avec des marquages sur sa plaque d'identification qui indiquent le code de température pour les environnements dangereux. Lorsque plusieurs produits sont combinés dans un système, le code de température le plus défavorable (code de température le plus faible) peut être utilisé pour déterminer le code de température global du système. Les combinaisons d'équipements dans le système sont sujettes à inspection par les autorités locales qualifiées au moment de l'installation.</p>
<div style="display: flex; align-items: center;">  <div> <p>AVERTISSEMENT: EXPLOSION HAZARD</p> <ul style="list-style-type: none"> • Do not disconnect equipment unless power has been removed or the area is known to be nonhazardous. • Do not disconnect connections to this equipment unless power has been removed or the area is known to be nonhazardous. Secure any external connections that mate to this equipment by using screws, sliding latches, threaded connectors, or other means provided with this product. • Substitution of components may impair suitability for Class I, Division 2. • If this product contains batteries, they must only be changed in an area known to be nonhazardous. </div> </div>	<div style="display: flex; align-items: center;">  <div> <p>AVERTISSEMENT: RISQUE D'EXPLOSION –</p> <ul style="list-style-type: none"> • Couper le courant ou s'assurer que l'environnement est classé non dangereux avant de débrancher l'équipement. • Couper le courant ou s'assurer que l'environnement est classé non dangereux avant de débrancher les connecteurs. Fixer tous les connecteurs externes reliés à cet équipement à l'aide de vis, loquets coulissants, connecteurs filetés ou autres moyens fournis avec ce produit. • La substitution de composants peut rendre cet équipement inadapté à une utilisation en environnement de Classe I, Division 2. • S'assurer que l'environnement est classé non dangereux avant de changer les piles. </div> </div>

Laser Radiation Ports



ATTENTION: Class 1 laser product. Laser radiation is present when the system is open and interlocks bypassed. Only trained and qualified personnel are allowed to install, replace, or service this equipment.

A redundant system is composed of two ControlLogix redundancy modules working together that supervise the operating states and state transitions that establish the basic framework for redundancy operations. The redundant pairs provide a bridge between chassis pairs that let other modules exchange control data and synchronize their operations. This illustration identifies the external features of the module.

Figure 11 - 1756-RM2/A or 1756-RM2XT Modules

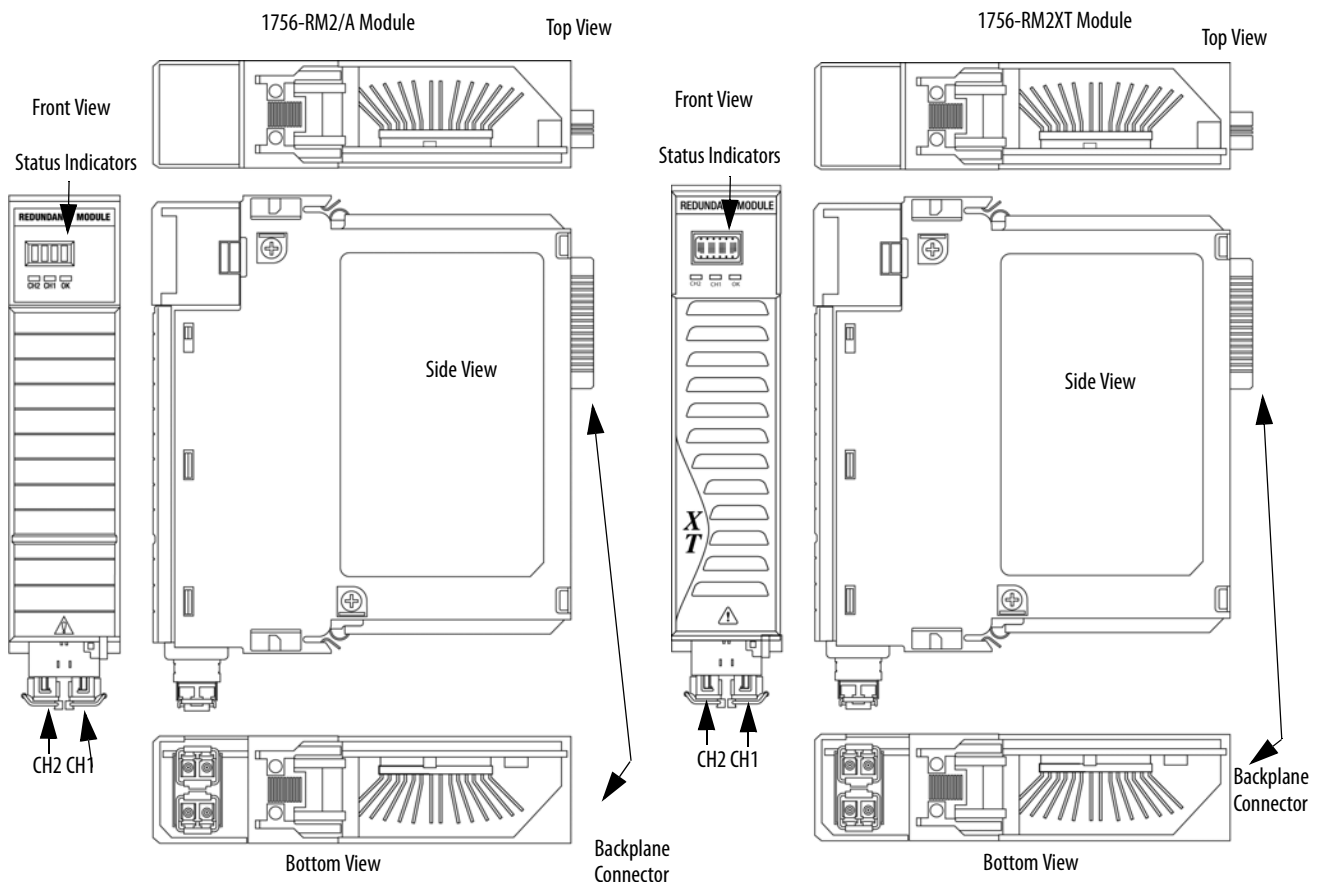

SFP transceivers are pre-installed in the redundant fiber ports

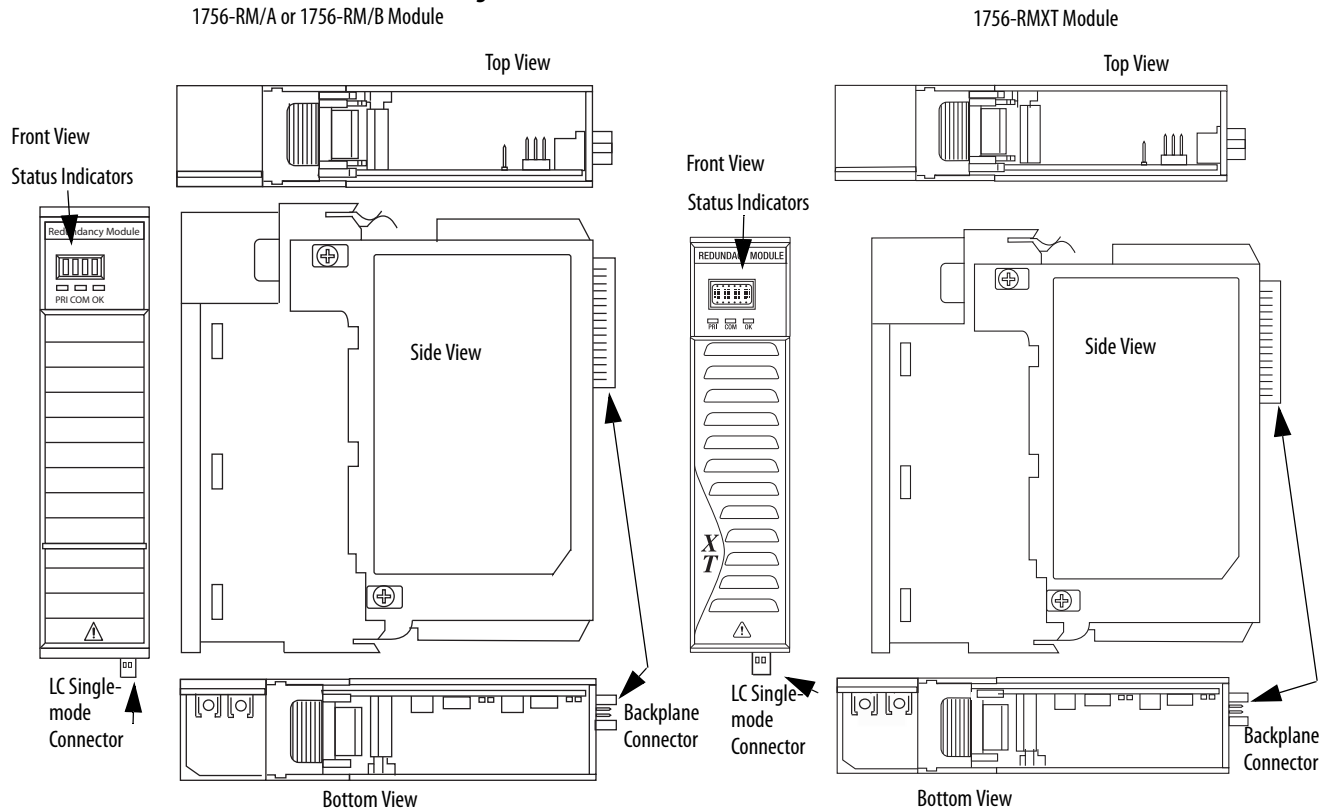
Figure 12 - 1756-RM/A or RM/B and 1756-RMXT Modules

To install the redundancy module, follow these steps.

1. Align the circuit board with top and bottom guides in the chassis.
2. Slide the module into the chassis and make sure that the module backplane connector properly connects to the chassis backplane.

The module is properly installed when it is flush with other installed modules.

IMPORTANT To remove the module, push the locking clips at the top and bottom of each module and slide the module out of the chassis.

IMPORTANT If you are adding redundancy to an already operational ControlLogix system, shut off your process to install the redundancy module. The first chassis that you install the redundancy module into and turn on, becomes the primary chassis.

You can also have to do the following:

- Use RSNetWorx™ software to configure keeper information in the secondary ControlNet® communication module if the master keeper for ControlNet communication is in the primary chassis
 - Enable redundancy in the programming software and remove any I/O modules from the chassis
-

The first chassis and its components are now installed. **Chassis power must remain off.**

Install the Second Chassis

Once the first chassis and its components are installed, you can install the second chassis of the redundant chassis pair.

See [Install the Redundancy Module on page 45](#) to install the second chassis.

IMPORTANT The components that are used in the first and second chassis must match exactly for the system to synchronize.

Connect the Redundancy Modules

Once the **first and second chassis and their components are installed**, you connect the redundancy modules via the 1756-RMC x fiber-optic communication cable. The cable is not included with the redundancy module. Before installation, order this fiber-optic communication cable separately.

Redundancy cables available from Rockwell Automation include the following.

Table 3 - Fiber-optic Cable Length

Fiber Cable Cat. No.	Length
1756-RMC1	1 m (3.28 ft)
1756-RMC3	3 m (9.84 ft)
1756-RMC10	10 m (32.81 ft)

The cable connection is made at the bottom of the module in a downward orientation. There is enough space between the transmit and receive connectors so you can use the LC connector coupler. The use of this coupler keeps the fiber-optic cable from bending so you can connect and disconnect the cable without removing the module from the chassis.



ATTENTION: Consider these points when connecting the fiber-optic cable:

- The redundancy module communication cable contains optical fibers. Avoid making sharp bends in the cable. Install the cable in a location where it will not be cut, run over, abraded, or otherwise damaged.
- The redundancy module contains a single-mode transmitter. Connecting this module to a multi-mode port will damage any multi-mode devices.
- Under certain conditions, viewing the optical port can expose the eye to hazard. When viewed under some conditions, the optical port can expose the eye beyond the maximum permissible-exposure recommendations.
- Media redundancy is achieved by installing modules with redundant ports and installing a redundant fiber cable system. If a cable failure occurs, or cable is degraded, the system uses the redundant network.
- When using a redundant system, route the two trunk cables (A and B) so that damage to one cable will not damage the other cable. This reduces both cables being damaged at the same time.
- Redundant cabling can tolerate one or more faults on a single channel. If a fault were to occur on both channels, the network operation would be unpredictable.

Connect the Fiber-optic Communication Cable to Redundant Channels

Follow this procedure to install the communication cable to redundant channels for the 1756-RM2/A module.

IMPORTANT The redundancy module communication cable contains optical fibers. Avoid making sharp bends in the cable. Install the cable in a location where it is not cut, run over, abraded, or otherwise damaged.

1. Remove the black protective plug on the first redundancy module in the redundant chassis pair.
2. Remove the protective caps from the cable.
3. Plug the cable connectors into the first redundancy module.

The ends must be inserted opposite each other.

4. If redundant fiber crossload cable is required, install the second fiber cable into the remaining port.
5. Plug the first end of the fiber cable into the CH1 port on the first chassis and plug the matching end into the matching CH1 port on the second chassis.

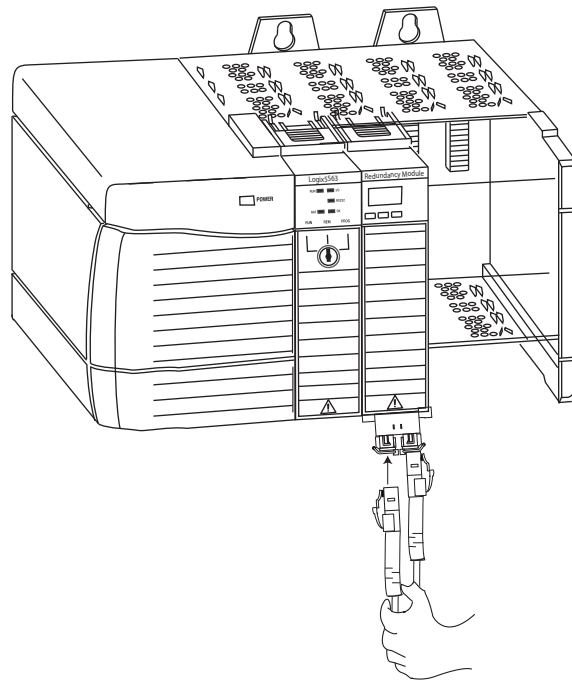

Connect the Fiber-optic Communication Cable to Single Channels

Follow this procedure to install the communication cable.

IMPORTANT The redundancy module communication cable contains optical fibers. Avoid making sharp bends in the cable. Install the cable in a location where it is not cut, run over, abraded, or otherwise damaged.

1. Remove the black protective plug on the first redundancy module in the redundant chassis pair.
2. Remove the protective caps from the cable.
3. Plug the cable connector into the first redundancy module.
4. Plug the remaining cable-connector end to the second redundancy module.

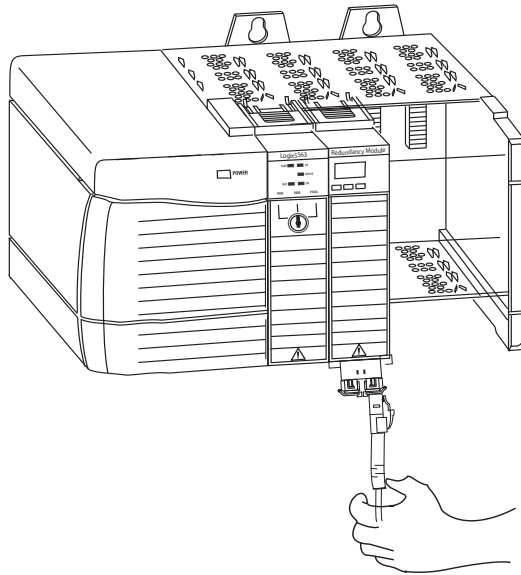

Fiber-optic Cable

If you choose to make your own fiber-optic cables, consider the following:

- Fiber-optic Communication Cable Specifications

Attribute	1756-RM2/A	1756-RM2XT	1756-RM/A or 1756-RM/B	1756-RMXT
Temperature, operating	0...60 °C (32...140 °F)	-25...70 °C (-13...158 °F)	0...60 °C (32...140 °F)	-25...70 °C (-13...158 °F)
Connector type	LC-type (fiber-optic)			
Cable type	8.5/125 micron single-mode fiber-optic cable			
Channels	1 (transmit and receive fiber)			
Length, max	10 km (10,000 m, 10936.13 yd)		4 km (4000 m, 4,374.45 yd) ⁽¹⁾	
Transmission	1000 Mbps		Less than or equal to 100 Mbps	
Wavelength	1310 nm		1300 nm	
SFP transceiver	Transceiver Rockwell Automation PN-91972 Connector/cable: LC duplex connector, 1000BASE-LX-compliant		—	

(1) Longer distances are supported based on the optical power budget of the system. See the [Optical Power Budget Ranges for 1756-RM2 and 1756-RM2XT Modules on page 56](#).

- Determine Optical Power Budget

You can determine the maximum optical-power budget in decibels (dB) for a fiber-optic link by computing the difference between the minimum transmitter-output optical power (dBm avg) and the lowest receiver sensitivity (dBm avg). As shown in [Table 4](#), the maximum optical power budget for the 1756-RM2 module is -9.5 - (-19) or 9.5 dB.

The optical-power budget provides the necessary optical-signal range to establish a working fiber-optic link. You must account for the cable lengths and the corresponding link penalties. All penalties that affect the link performance must be accounted for within the link optical power budget.

Table 4 - Optical Power Budget Ranges for 1756-RM2 and 1756-RM2XT Modules

Transmitter	Min	Typical	Max	Unit
Output optical power	-9.5	—	-3	dBm
Wavelength	1270	—	1355	nm
Receiver	Min	Typical	Max	Unit
Receiver sensitivity	—	—	-19	dBm
Receiver overload	—	—	-3	dbm
Input operating wavelength	1270	—	1355	nm

Use Dual Fiber Ports with the 1756-RM2/A Redundancy Module

The dual fiber ports of the 1756-RM2/A module constitute a redundant pair of communication channels between the partner 1756-RM2 modules in a redundant chassis pair. One of the channels is termed as 'ACTIVE', while the other channel is termed as 'REDUNDANT'. All data communication between the partner redundancy modules is conducted exclusively over the ACTIVE channel. If or when the ACTIVE channel fails, a 'Fiber Channel Switchover' is initiated automatically and all data communication shifts to the REDUNDANT channel, which then becomes the new ACTIVE channel.

Fiber Channel Switchover

Due to the fiber channel switchover, the redundant chassis pair remains synchronized even after a failure of the ACTIVE channel. Any of the following failures of the ACTIVE channel trigger an automatic fiber channel switchover to the REDUNDANT channel, provided the REDUNDANT channel is still operating in a normal condition:

- Signal attenuation along the fiber cable path that is routed between the partner redundancy modules
- A broken or damaged fiber cable that is routed between the partner redundancy modules
- Improper or loosely fit cable connector
- SFP transceiver fault
- Removal or loose connection of the SFP transceiver
- Data communication error (signaled by a failed CRC check)

Chassis synchronization is lost only when both of the channels have failed or are disconnected.

The fiber channel switchover can occasionally extend the completion of data communication packets between the partner redundancy modules. Therefore, the scan time of the controller can occasionally experience a delay of 10 ms or less.

Configuration

The use of dual fiber ports is entirely 'plug and play'. There is no user configuration that is needed for any of the operations of the active and redundant channels. The firmware automatically manages the selection of active and redundant channels. The dual fiber cables between the partner redundancy modules can be crossed over between CH1 and CH2 without any restriction.

Monitoring and Repair

Synchronization is preserved if the REDUNDANT channel has failed or is being repaired. The repair of the REDUNDANT channel can be performed online while the redundant chassis pair is running synchronized. To aid online repairs, the fiber cable connections and SFP transceiver can be removed and inserted under power.

It is not mandatory to have the REDUNDANT channel that is connected between the two redundancy modules. The redundant chassis pair can be synchronized with just one of the channels connected. The REDUNDANT channel can be installed later while the chassis is running synchronized.

The status indicators on the front panel and the indicators and counters that are displayed in the RMCT provide monitoring of the channel status.

Update Redundant Firmware

Use ControlFLASH software to upgrade the firmware of each module in each chassis.

IMPORTANT Apply power **ONLY** to the chassis that contains modules on which you are upgrading firmware.
Update firmware on only one module at a time.

IMPORTANT Redundancy module firmware that is contained in the redundancy system firmware bundle is designed for use with the 1756-RM, 1756-RM2, 1756-RMXT, and 1756-RM2XT redundancy modules.

Upgrade the Firmware in the First Chassis

Complete these steps to upgrade the firmware in the first chassis.

1. Apply power to the chassis.

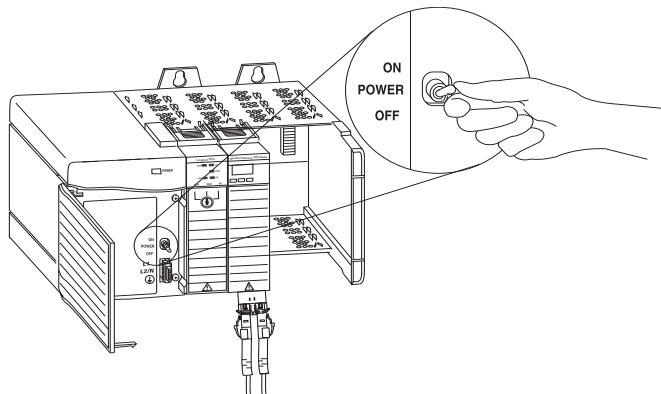

- Set the mode switch on the controller to REM.

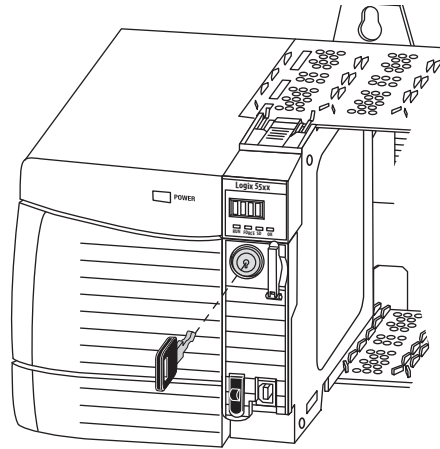

- Wait for the redundancy module to complete its start-up scroll messages. Check Module and status indicators. Wait 45 seconds before you begin updating the 1756-RM firmware. During this time, the redundancy module conducts internal operations to prepare for an update.

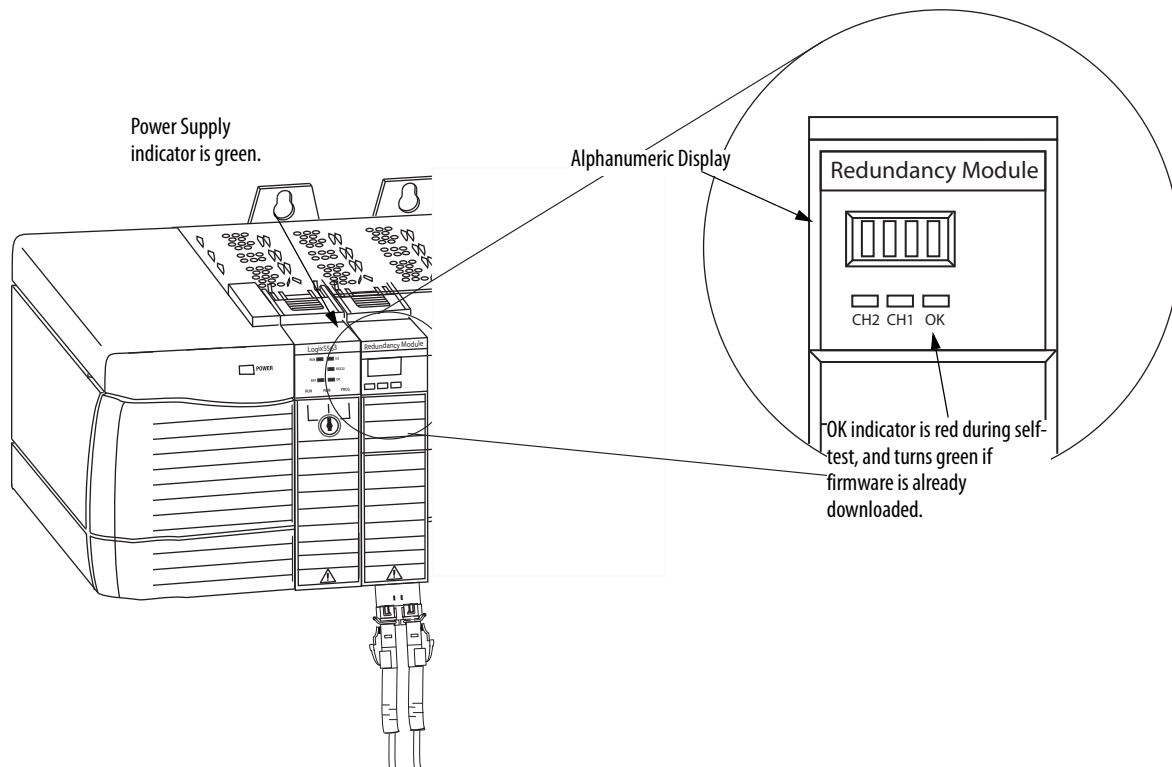

TIP If it is a new module, wait until APPLICATION UPDATE REQUIRED is displayed. The status indicator flashes red.

- Launch ControlFLASH software and click Next to begin the update process.

5. Select the catalog number of the module (upgrade the redundancy module first) and click Next.

IMPORTANT The 1756-RM2 module uses different firmware than the 1756-RM and 1756-RMXT modules.

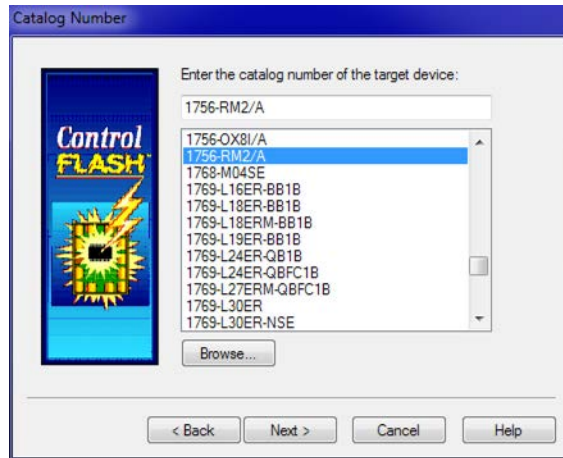

6. Expand the network driver to locate the redundancy module or module you are upgrading.

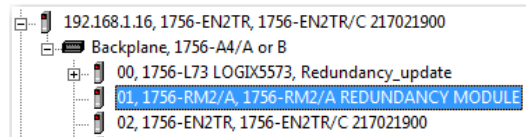

7. Select the module and click OK.
8. Select the firmware revision that you want to update to and click Next.
9. Click Finish.
10. On the confirmation dialog box that appears click Yes.

IMPORTANT This process can take a few minutes. The system can look like it is not doing anything, but it is. When the update is complete, the Update Status dialog box appears and indicates that the update has successfully completed.

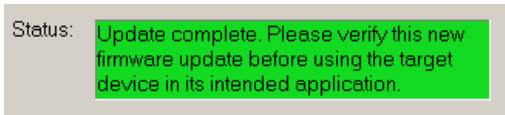

11. Click OK.
12. Verify that the redundancy module status displays PRIM, which indicates a successful upgrade.
13. Complete steps 4...12 for each module in the chassis.

IMPORTANT Power off the first chassis after you have verified a successful update of each module.

Upgrade the Firmware in the Second Chassis

Complete these steps to update the firmware for the modules in the second chassis.

1. Apply power to the second chassis.
2. Complete steps [3...12](#) in section [Upgrade the Firmware in the First Chassis](#) beginning on [page 58](#) for the modules in the second chassis.
3. Power off the second chassis after you have verified the successful upgrade of each module.

Designate the Primary and Secondary Chassis

Power on the chassis you want to designate as the primary chassis first. After you have applied power, qualify the system so that all module pairs are at compatible firmware revision levels.

IMPORTANT Do not apply power to the chassis until you have read the instructions for designating the primary chassis. Applying power to the chassis in the correct order is crucial to designating the primary and secondary chassis. Do not attempt to designate a primary chassis before loading in an application image. Before you designate the primary chassis and qualify the system, make sure that you have the latest firmware installed. See [Update Redundant Firmware on page 58](#).

Complete these steps to designate the primary and secondary chassis of a redundant pair.

1. Verify that power is removed from both chassis.
2. Apply power to the chassis you want to designate as the primary chassis and wait for the status indicators of the module to display **PRIM**.
3. Apply power to the chassis you want to designate as the secondary chassis.
4. Verify primary and secondary chassis designations by viewing the module status display and the PRI indicator.

See [Redundancy Module Status Indicators on page 207](#) for specific redundancy module display information.

IMPORTANT If both modules have power applied to them simultaneously, the module with the lowest IP address is designated as the primary chassis and displays PRIM on the four-character display of the module. In addition, the PRI status indicator on the primary redundancy module is green. The secondary chassis displays either DISQ or SYNC, depending on the state of the secondary chassis. In addition, the PRI status light on the secondary redundancy module is not illuminated.

After Designation

When you first apply power to the designated primary and secondary chassis, compatibility checks are carried-out between the redundant chassis. Then, because the default Auto-Synchronization parameter is set at Always, qualification begins.

TIP While the qualification occurs, the module status display transitions from DISQ (disqualified) to QFNG (qualifying) to SYNC (synchronized). The qualification s complete in 1...3 minutes and then module status display indicates the qualification status.

Use this table as a reference when interpreting the qualification status of the modules that are displayed on the module status display.

Module Status Display	Interpretation
QFNG	Qualification processes are in progress.
SYNC	SYNC displays after qualification processes are complete. This indicates that chassis configuration and the firmware revision levels are compatible and that the secondary chassis is ready to assume control if there is a major fault in the primary chassis.
DISQ...QFNG...DISQ	If DISQ continues to display after about 3 minutes, one of these anomalies exists: <ul style="list-style-type: none"> • Incorrect chassis configuration. That is, incompatible hardware is used. • Incompatible firmware revisions are used between the primary and secondary modules. • Keeper parameters between ControlNet module partners are not the same. • The partnered ControlNet modules are not set to the same node address. • The Auto-Synchronization parameter within the Redundancy Module Configuration Tool is set to Never or Conditional (default setting).

Conversion from a Non-redundant to a Redundant System

To upgrade the standalone chassis to a redundant chassis pair:

1. Insert a redundancy module in the standalone chassis and
2. Configure an identical chassis with compatible modules in the same slot as the standalone chassis (including the redundancy module).

If the partnered chassis contains non-redundant modules or non-redundancy-compliant firmware, and is designated as the secondary chassis, it stops functioning.

A partnered chassis that contains non-redundant modules or non-redundancy-compliant firmware stops functioning if it is designated as the secondary chassis.

For more information, see [Convert from a Non-redundant System on page 215](#).

Qualification Status Via the RMCT

To view the qualification attempt, access the Synchronization or Synchronization Status tabs of the RMCT. These tabs provide information about qualification attempts and redundant chassis compatibility.

For more information on how to use the RMCT, see [Chapter 6, Configure the Redundancy Modules on page 89](#).

Figure 13 - RMCT Synchronization Status Tab

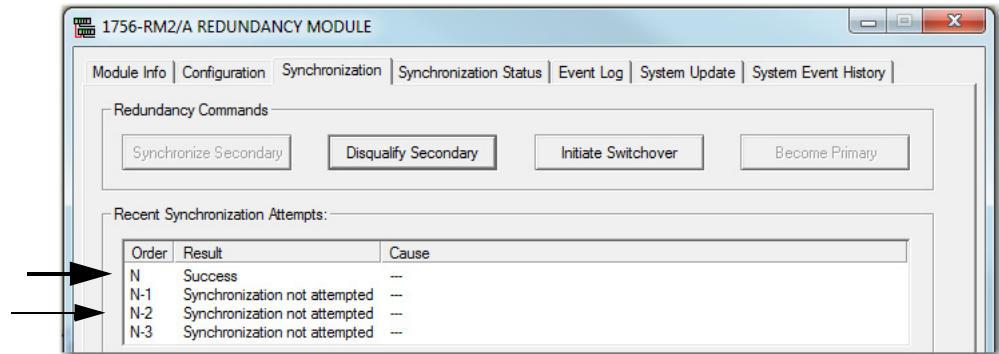

Figure 14 - Synchronization Status Tab for Chassis Compatibility

Chassis A: Primary with Synchronized Secondary
Auto-Synchronization State: Always

In addition, you can view events specific to qualification in the Event Log of the RMCT.

Figure 15 - Event Log with Qualification Events

Event	Log Time	Slot	Module Na...	Description	Classification
3407	12/16/2015 15:21:30:118	1	1756-RM2	(32) Autoqual. State Change	Configuration
3406	12/16/2015 15:21:30:117	1	1756-RM2	(F) Autoqual. Option Set to 'Always'	Configuration
3405	12/16/2015 15:05:47:592	1	1756-RM2	(1A) Chassis Redundancy State changed ...	State Changes
3404	12/16/2015 15:05:47:461	2	1756-EN2TR	(14) Enter Qualification Phase 4	Qualification
3403	12/16/2015 15:05:47:434	1	1756-RM2	(2E) Qualification Complete	Qualification
3402	12/16/2015 15:05:47:421	2	1756-EN2TR	(13) Enter Qualification Phase 3	Qualification
3401	12/16/2015 15:05:46:426	2	1756-EN2TR	(12) Enter Qualification Phase 2	Qualification
3400	12/16/2015 15:05:44:670	2	1756-FN2TR	(11) Enter Qualification Phase 1	Qualification

Reset the Redundancy Module

There are two ways to reset the module.

- Cycle power to the chassis.
- Remove the module from the chassis and reinsert the module.

IMPORTANT Do not choose to cycle power to the chassis if it causes you to lose control of your process.

Remove or Replace the Redundancy Module

To remove or replace the redundancy module, follow these steps.

1. To disengage the upper and lower module tabs, push them.
2. Slide the module out of the chassis.

IMPORTANT If you want to resume system operation with an identical module, you must install the new module in the same slot.

Configure the EtherNet/IP Network

Topic	Page
Requested Packet Interval	65
IP Address Swapping	66
CIP Sync	69
Produce/Consume Connections	72
Configure EtherNet/IP Communication Modules in a Redundant System	73
Use a Redundancy System with Device Level Ring	75
Use a Redundancy System with Parallel Redundancy Protocol	76

Requested Packet Interval

When using revisions earlier than 20.054, the RPI for I/O connections in a redundancy-enabled controller tree must be less than or equal to 375 ms. When using revision 20.054 or later, the RPI can be the same as a non-redundant chassis.

CPU Usage

[Table 5](#) describes CPU usage for EtherNet/IP™ communication modules.

Table 5 - System Resource Utilization Table

If the CPU utilization rate is	Then
0...80%	No action is required. Important: This range is the optimal rate.
Greater than 80%	<ul style="list-style-type: none"> Take steps to reduce your CPU utilization. See the EtherNet/IP Network Configuration User Manual, publication ENET-UM001. Adjust the requested packet interval (RPI) of your connection. Reduce the number of devices that are connected to your module. <p>Important: Your EtherNet/IP communication module can function at 100% CPU capacity, but at or near this rate, you run the risk of CPU saturation and performance problems.</p>

IP Address Swapping

IP address swapping is a feature available to EtherNet/IP communication modules in a redundancy system where a partnered set of EtherNet/IP communication modules swap IP addresses during a switchover.

IMPORTANT You must use IP address swapping to use remote I/O and produce/consume connections of an EtherNet/IP network.

Determine Use of IP Address Swapping

Depending on your EtherNet/IP network configuration, you can choose to use IP address swapping between your partnered EtherNet/IP communication modules in the event of a switchover.

If your partnered EtherNet/IP communication modules are on the	Then
Same subnet	use IP address swapping
Different subnets	do not use IP address swapping

If you are using different subnets, you are responsible for programming your system to use the address and subnet of the new primary chassis in the event of a switchover.

Use IP Address Swapping

If you use IP address swapping, assign the same values for these configuration parameters on both EtherNet/IP communication modules in the partnered set:

- IP address
- Subnet mask
- Gateway address

[Figure 16](#) shows a partnered set of EtherNet/IP communication modules during initial configuration.

Figure 16 - IP Addresses of EtherNet/IP Communication Modules During System Configuration

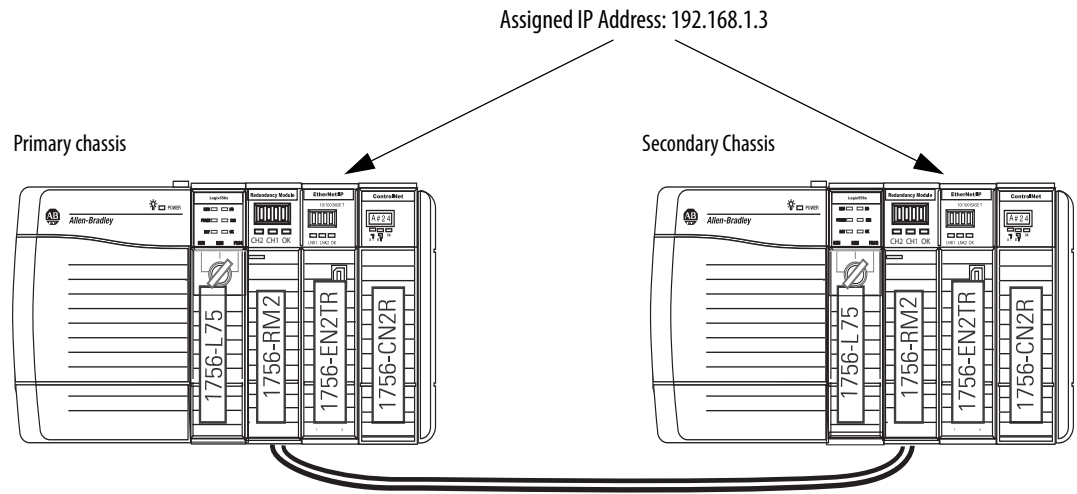

When a redundancy system begins operating, the primary EtherNet/IP communication module uses the IP address that is assigned during initial configuration. The secondary EtherNet/IP communication module automatically changes its IP address to the next highest value. When a switchover occurs, the EtherNet/IP communication modules swap IP addresses.

For example, if you assign IP address 192.168.1.3 to both EtherNet/IP communication modules in a partnered set, on initial system operation, the secondary EtherNet/IP communication module automatically changes its IP address to 192.168.1.4.

[Figure 17](#) shows a partnered set of EtherNet/IP communication modules after system operation begins.

Figure 17 - IP Addresses of EtherNet/IP Communication Modules After System Operation Begins

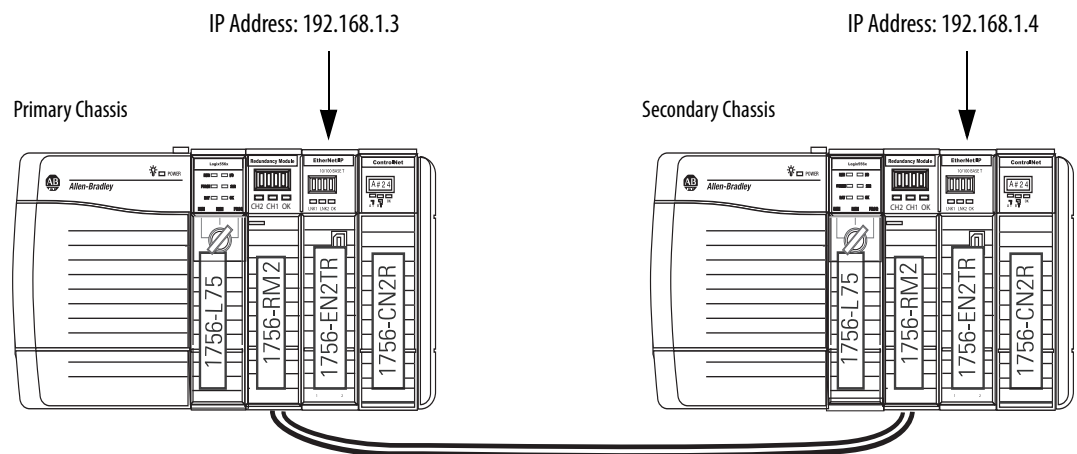

TIP Do not assign IP addresses to EtherNet/IP communication modules outside the partnered set to values that conflict with those values that are used in the partnered set.

In the previous example, the partnered set uses 192.168.1.3 and 192.168.1.4. Use 192.168.1.5 or higher for all EtherNet/IP communication modules outside the partnered set.

Figure 18 shows the partnered set of EtherNet/IP communication modules in RSLinx® Classic software after system operation begins.

Figure 18 - IP Addresses in RSLinx Classic Software

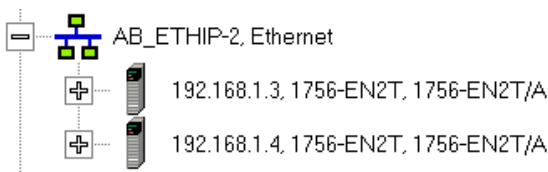

Static Versus Dynamic IP Addresses

We recommend that you use static IP addresses on EtherNet/IP communication modules in redundancy systems.



ATTENTION: If you use dynamic IP addresses and a power outage, or other network failure occurs, modules that use dynamic IP addresses can be assigned new addresses when the failure is resolved. If the IP addresses change, your application could experience a loss of control or other serious complications with your system.

You cannot use dynamic IP addresses with IP address swapping.

Reset the IP Address for an EtherNet/IP Communication Module

If necessary, you can reset the IP address of a 1756-EN2x communication module to the factory default value. To return to the factory default, set the rotary switches on the module to 888 and cycle power.

After you cycle power to the EtherNet/IP communication module, you can either set the switches on the module to the desired address, or set the switches to 999 and use one of these methods to set the IP address:

- BOOTP-DHCP server
- RSLinx Classic communication software
- Programming software

CIP Sync

With redundancy system revision 19.052 or greater, you can use CIP Sync™ technology. CIP Sync technology provides a mechanism to synchronize clocks between controllers, I/O devices, and other automation products in your architecture with minimal user intervention.

CIP Sync technology uses Precision Time Protocol (PTP) to establish a Master/Slave relationship among the clocks for each CIP Sync-enabled component in the system. One master clock, which is known as the Grandmaster, sets the clock to which all other devices on the network synchronize their clocks.

IMPORTANT Before you use this enhancement in a redundancy system, revision 19.052 or later, see these publications for a full understanding of CIP Sync technology in any system:

- Integrated Architecture™ and CIP Sync Configuration Application Technique, publication [IA-AT003](#)
 - ControlLogix® System User Manual, publication [1756-UM001](#)
-

Consider these points when you use CIP Sync technology in a redundancy system, revision 19.052 or later:

- If you enable CIP Sync Time Synchronization in the controllers in a redundant chassis pair, you must also enable Time Synchronization in the EtherNet/IP communication modules in the redundant chassis pair so all devices have one path to the Grandmaster.

If time synchronization is enabled in any controller in the primary chassis of a disqualified redundant chassis pair, and no other devices in the primary chassis have time synchronization enabled, the redundant chassis pair attempts to qualify. However, in these application conditions, the attempt to qualify fails.

- While CIP Sync technology can handle multiple paths between master and slave clocks, it resolves mastership most effectively if you configure the redundant paths so that Time Synchronization is enabled in only the minimum required number of EtherNet/IP communication modules.

For example, if your redundant chassis pair has three 1756-EN2T communication modules and all are connected to the same network, enable Time Synchronization in only one of the modules.

- If the primary controller is the Grandmaster, the redundancy system automatically manages the CIP Sync clock attributes so that the controller in the primary chassis is always set to be the Grandmaster instead of the secondary controller. This clock management makes sure of a change to a new Grandmaster when the redundancy system switches over.
- When a switchover occurs, these events take place:
 - The Grandmaster status transfers from the original primary controller to the new primary controller. This transfer can take longer to complete than if Grandmaster status was transferred between devices in a non-redundant system.
 - After the switchover is complete, system synchronization can take longer in a redundancy system, revision 19.052 or later, which uses CIP™ technology than one that does not.
- If you attempt to use the Redundant System Update (RSU) feature to update a redundancy system, revision 16.081 or earlier, which uses Coordinated System Time (CST), the redundancy system, revision 19.052 or later, does not permit a locked switchover and the update fails to complete.

To work around this restriction, first disable CST Mastership in the original redundancy system and then use RSU to update the redundancy system to revision 19.052 or later.

Figure 19 shows an example redundancy system, revision 19.052 or later, that uses CIP Sync technology.

Use of **ControlNet® is not required** when using CIP Sync technology in a redundancy system. It is included in Figure 19 for example purposes.

Figure 19 - Redundancy System, Revision 19.052 or greater, Using CIP Sync Technology

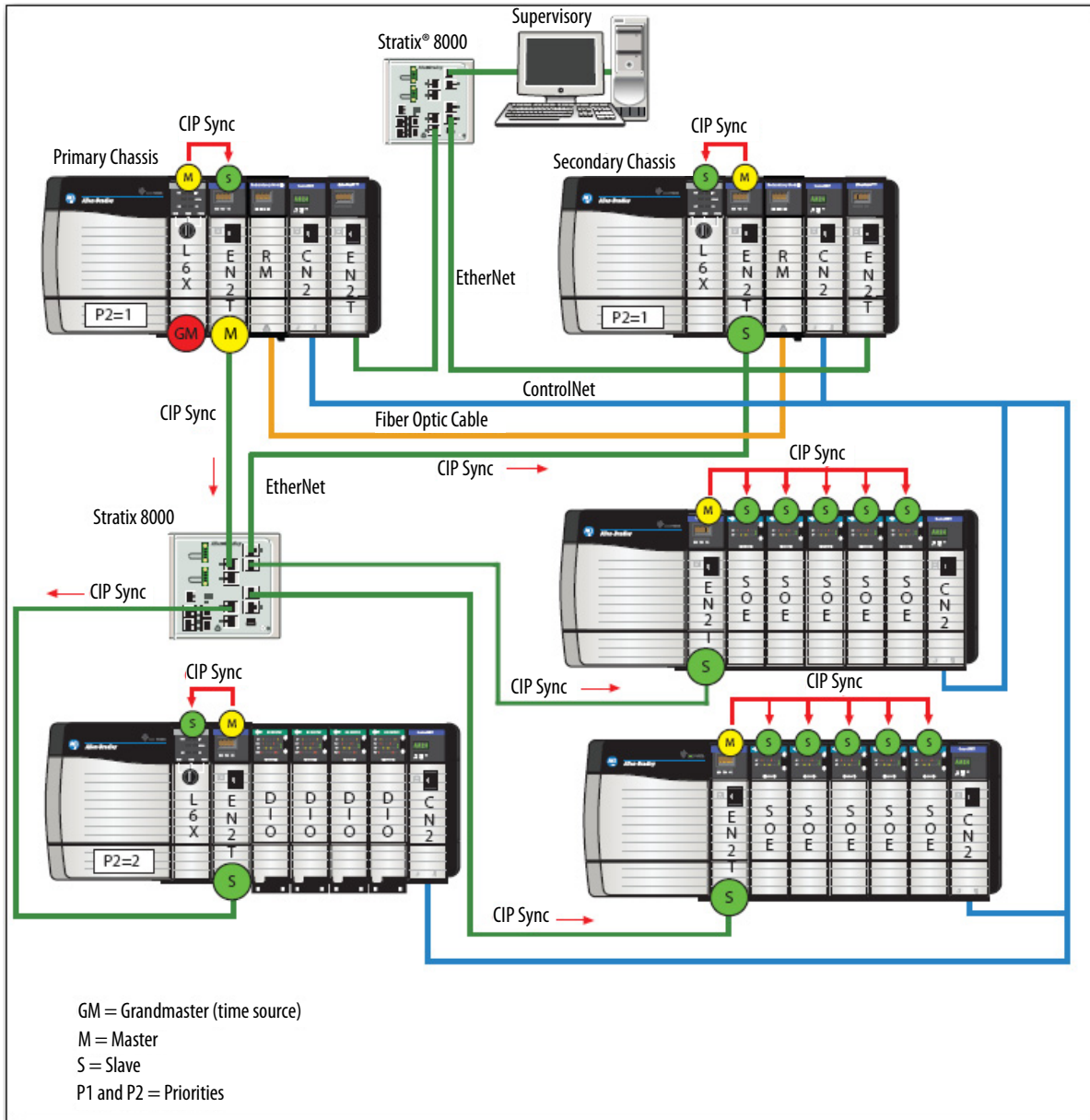

Produce/Consume Connections

With redundancy system revision 19.052 or later, you can use produce/consume connections over an EtherNet/IP network. Controllers let you produce (broadcast) and consume (receive) system-shared tags.

TIP When using ControlLogix 5570 controllers in your system, you must use revision 19.053 or greater.

Figure 20 - Example System Using Produced and Consumed Tags

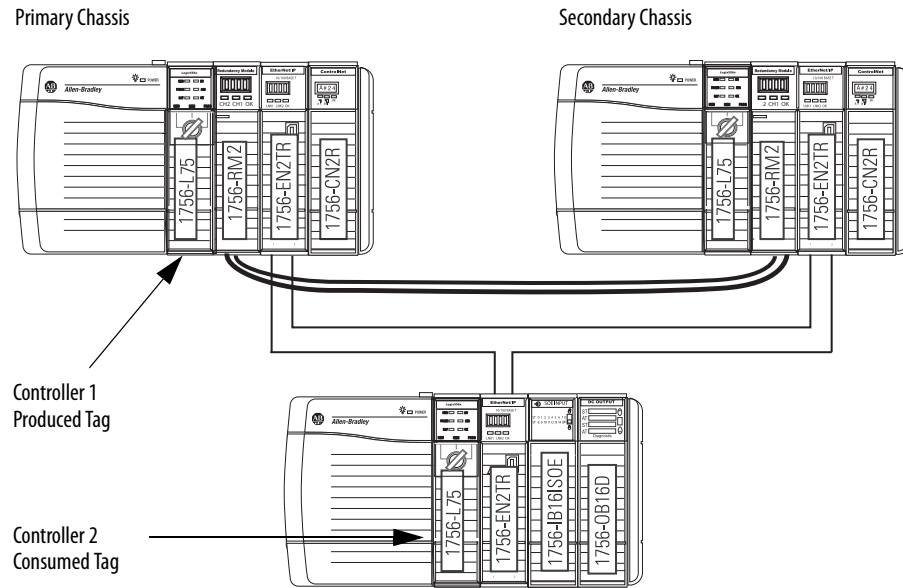

These requirements exist when you use produced and consumed connections over an EtherNet/IP network in a redundancy system, revision **19.052** or greater:

- You cannot bridge produced and consumed tags over two networks. For two controllers to share produced or consumed tags, both must be attached to the same network.
- Produced and consumed tags use connections in both the controllers and the communication modules being used.
- Because the use of produced and consumed tags uses connections, the number of connections available for other tasks, such as the exchange of I/O data, is reduced.

The number of connections available in a system depends on controller type and network communication modules used. Closely track the number of produced and consumed connections to leave as many as necessary for other system tasks.

- You must configure both connections, that is, the connection between the primary controller and the remote controller, and the connection between the remote controller and the primary controller, for Multicast. However, if the redundancy system is the producer, it can be Unicast, because that is configured in the remote controller, which is allowed.

IMPORTANT Sockets are supported in the 1756-EN2T, 1756-EN2TR and 1756-EN2F modules, firmware revision 5.008 or later. For additional information, see the EtherNet/IP Socket Interface Application Technique, publication [ENET-AT002](#).

IMPORTANT Unicast functionality in redundancy systems supports produced tags. Unicast consumed tags are not supported.

Configure EtherNet/IP Communication Modules in a Redundant System

Use these procedures to configure EtherNet/IP communication modules that are used in redundant chassis.

Before You Begin

Before you begin configuring the EtherNet/IP communication modules in the redundant chassis, verify that these tasks have been completed:

- The redundancy modules are installed and connected in the redundant chassis.
- A plan for IP address use has been executed:
 - If you are using IP address swapping, plan for the use of two consecutive IP addresses in the partnered set.
 - If you are not using IP address swapping, plan for the use of two IP addresses.
- Know the subnet mask and gateway address for the Ethernet network the redundant modules are to operate on.

Options for Setting the IP Addresses of EtherNet/IP Communication Modules

By default, ControlLogix EtherNet/IP communication modules ship with the IP address set to 999 and with Bootstrap Protocol (BOOTP)/Dynamic Host Configuration Protocol (DHCP)-enabled.

Use one of these tools to set the IP addresses for your EtherNet/IP communication modules:

- Rotary switches on the module
- RSLinx Classic communication software
- Programming software
- BOOTP/DHCP utility - Provided with programming software

Half/Full Duplex Settings

The redundancy system uses the duplex settings of the EtherNet/IP communication module that is the primary. After a switchover, the duplex settings of the new primary EtherNet/IP communication module are used. By default, the duplex setting is automatic. We recommend that you use this setting whenever possible.

To avoid communication errors, configure both the primary and secondary EtherNet/IP communication modules with the same duplex settings. If you use different duplex settings on partnered EtherNet/IP communication modules, then messaging errors can occur after a switchover.

Use a Redundancy System with Device Level Ring

Device Level Ring (DLR) is an EtherNet/IP protocol defined by the Open DeviceNet® Vendors' Association (ODVA). DLR provides a means for detecting, managing, and recovering from single faults in a ring-based network.

A DLR network includes the following types of ring nodes.

Node	Description
Ring supervisor	<p>A ring supervisor provides these functions:</p> <ul style="list-style-type: none"> • Manages traffic on the DLR network • Collects diagnostic information for the network <p>A DLR network requires at least one node to be configured as ring supervisor.</p> <p>IMPORTANT: By default, the supervisor function is disabled on supervisor-capable devices, so they are ready to participate on a linear or star network or as a ring node on a DLR network.</p> <p>In a DLR network, you must configure at least one of the supervisor-capable devices as the ring supervisor before physically connecting the ring. If you do not, the DLR network does not work.</p>
Ring participants	<p>Ring participants provide these functions:</p> <ul style="list-style-type: none"> • Process data that is transmitted over the network. • Pass on the data to the next node on the network. • Report fault locations to the active ring supervisor. <p>When a fault occurs on the DLR network, ring participants reconfigure themselves and relearn the network topology.</p>
Redundant gateways (optional)	<p>Redundant gateways are multiple switches connected to a single DLR network and also connected together through the rest of the network.</p> <p>Redundant gateways provide DLR network resiliency to the rest of the network.</p>

Depending on their firmware capabilities, both devices and switches can operate as supervisors or ring nodes on a DLR network. Only switches can operate as redundant gateways.

For more information about DLR, see the EtherNet/IP Device Level Ring Application Technique, publication [ENET-AT007](#).

Use a Redundancy System with Parallel Redundancy Protocol

Parallel Redundancy Protocol (PRP) is defined in international standard IEC 62439-3 and provides high-availability in Ethernet networks. PRP technology creates seamless redundancy by sending duplicate frames to two independent network infrastructures, which are known as LAN A and LAN B.

A PRP network includes the following components.

Component	Description
LAN A and LAN B	Redundant, active Ethernet networks that operate in parallel.
Double attached node (DAN)	An end device with PRP technology that connects to both LAN A and LAN B.
Single attached node (SAN)	An end device without PRP technology that connects to either LAN A or LAN B. A SAN does not have PRP redundancy.
Redundancy box (RedBox)	A switch with PRP technology that connects devices without PRP technology to both LAN A and LAN B.
Virtual double attached node (VDAN)	An end device without PRP technology that connects to both LAN A and LAN B through a RedBox. A VDAN has PRP redundancy and appears to other nodes in the network as a DAN.
Infrastructure switch	A switch that connects to either LAN A or LAN B and is not configured as a RedBox.

For more information about PRP topologies and configuration guidelines, see the EtherNet/IP Parallel Redundancy Protocol Application Technique, publication [ENET-AT006](#).

Configure the ControlNet Network

Topic	Page
Produce/Consume Connections	77
Network Update Time	79
Scheduled or Unscheduled Network	81
Schedule a New Network	82
Update an Existing Scheduled Network	85
Check the Network Keeper States	86

Produce/Consume Connections

You can use produce/consume connections over a ControlNet® network. Controllers let you produce (broadcast) and consume (receive) system-shared tags.

Figure 21 - Example System Using Produced and Consumed Tags

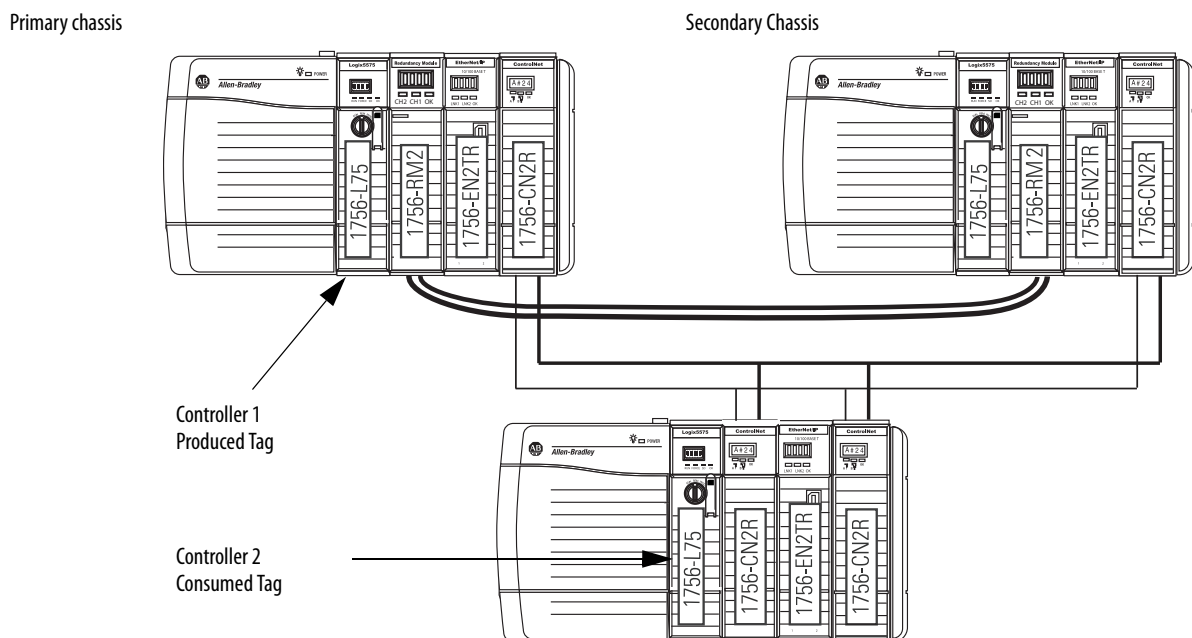

Keep these points in mind when you use produced and consumed connections over a ControlNet network in a redundancy system:

- During a switchover, the connection for tags that are consumed from a redundant controller can drop briefly.
 - The data does not update.
 - The logic acts on the last data that it received.

After the switchover, the connection is re-established and the data begins to update again.

- You cannot bridge produced and consumed tags over two networks. For two controllers to share produced or consumed tags, both must be attached to the same network.
- Produced and consumed tags use connections in both the controllers and the communication modules being used.
- Because the use of produced and consumed tags uses connections, the number of connections available for other tasks, such as the exchange of I/O data, is reduced.

The number of connections available in a system depends on controller type and network communication modules used. Closely track the number of produced and consumed connections to leave as many as necessary for other system tasks.

Network Update Time

The network update time (NUT) that you specify for your redundant system affects your system performance and your switchover response time. Typical NUTs used with redundant systems range from 5...10 ms.

NUTs with Multiple ControlNet Networks

You can choose to use multiple ControlNet networks with your redundancy system.

Figure 22 - Example of Two ControlNet Networks

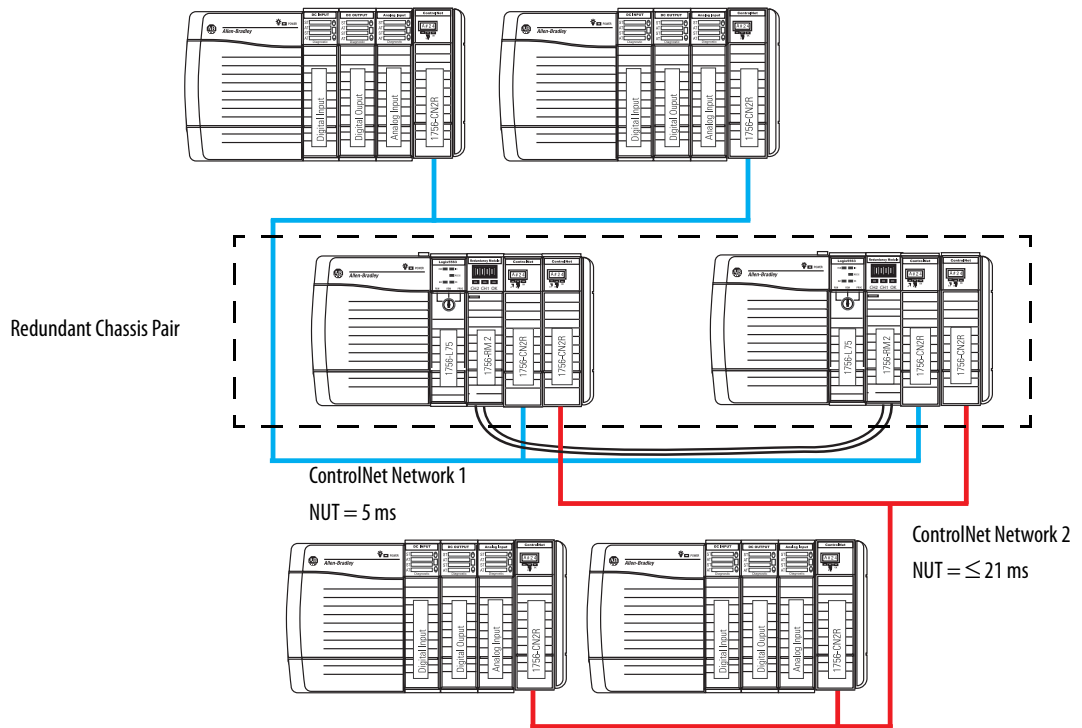

When you use multiple ControlNet networks, the networks must use compatible NUTs. Compatible NUTs are determined based on the network that uses the smallest NUT.

Use [Table 6](#) to determine the compatible NUTs for your system.

Table 6 - Compatible NUT Values for Multiple ControlNet Networks

If the smallest NUT of a network is (ms)	Then the largest NUT of any other network must be less than or equal to (ms)
2	15
3	17
4	19
5	21
6	23
7	25
8	27
9	29
10	31
11	33
12	35
13	37
14	39
15	41
16	43
17	46
18	48
19	50
20	52
21	55
22	57
23	59
24	62
25	64
26	66
27	68
28	71
29	73
30	75
31	78
32	80
33	82
34	84
35	87
36	89
37...90	90

Scheduled or Unscheduled Network

It is up to you to if you want to use a scheduled or unscheduled network.

Use a Scheduled Network

Schedule or reschedule your ControlNet network when you execute these tasks:

- Commission a new redundant system.
- Add a chassis of remote ControlLogix® I/O that is set to use the Rack Optimized communication format.
- Add any remote I/O besides ControlLogix I/O. For example, if you add FLEX™ I/O modules, you must schedule the network.
- Use produced/consumed data. If you add a produced/consumed data tag, you must reschedule the ControlNet network.

To schedule or reschedule your ControlNet network, you put your redundant system in Program mode.

Use an Unscheduled Network

You can use an unscheduled network when you:

- Add a remote I/O chassis of ControlLogix I/O that does not use the Rack Optimized communication format. That is, direct connections to the I/O are used.
- Add a ControlLogix I/O module to a chassis that has already been scheduled and uses the Rack Optimized communication format.
- Add some drives that support adding I/O while online.
- Use ControlNet to monitor HMI or the controller program.

You can add those components to the unscheduled network while your redundant system is online and in Run mode. We recommend that you do not use an unscheduled network for all of your I/O connections.

The use of 1756-CN2/B, 1756-CN2R/B, and 1756-CN2RXT modules provide increased capacity for adding I/O while online compared to 1756-CNB or 1756-CNBR modules. With this increased capacity, you can easily add I/O and increase ControlNet connections that are used without affecting your redundant system performance.

Add Remote ControlNet Modules While Online

If you are adding a remote I/O chassis that is composed of a ControlLogix ControlNet module and ControlLogix I/O while your redundant system is running (online), make these considerations:

- Do not use Rack Optimized communication formats. The ControlNet module and I/O must be configured for direct connections.
- For each remote I/O module used, plan for one direct connection to be used.

Schedule a New Network

Complete these steps to schedule a new ControlNet network for a redundancy system.

IMPORTANT Before you schedule a ControlNet network, turn on the power to both redundant chassis.

If you schedule a ControlNet network while the secondary chassis is off, the keeper signature of a 1756-CN2/B or 1756-CN2R/B module can mismatch its partner. This action can cause the secondary chassis to fail to synchronize.

1. Turn on the power to each chassis.
2. Start RSNetWorx™ for ControlNet software.
3. From the File menu, choose New.
4. At the New File dialog box, choose a configuration type.

This example uses ControlNet Configuration.

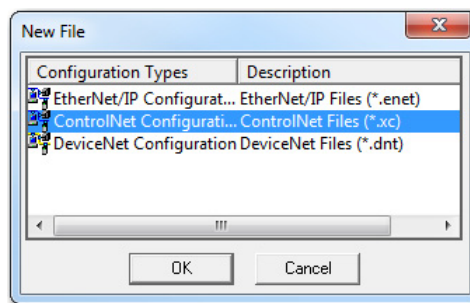

5. From the Network menu, choose Online.
6. Select your ControlNet network and click OK.

7. From the Network menu, choose Enable Edits.

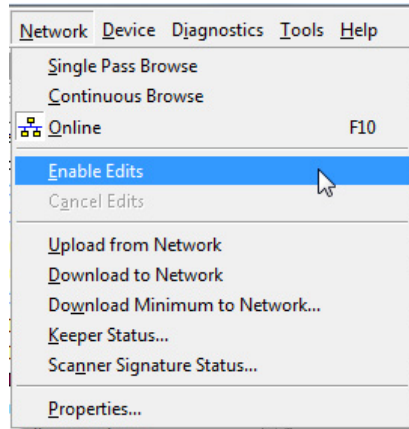

8. From the Network menu, choose Properties.

9. In the Network Parameters tab, enter the parameters that are appropriate for your system.

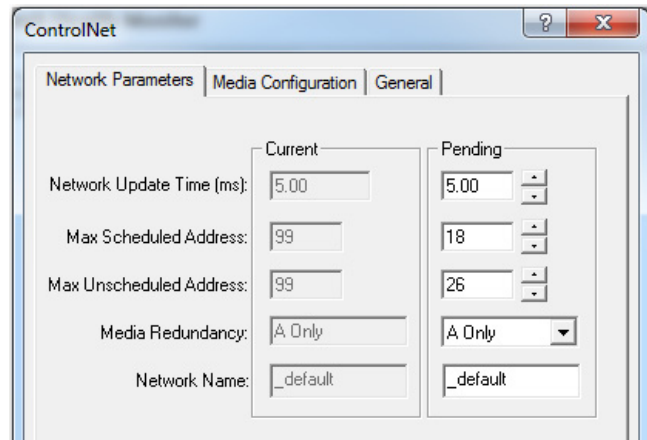

Parameter	Specify
Network Update Time (ms)	The minimum repetitive interval when data is sent over the ControlNet network.
Max Scheduled Address	The highest node number that uses scheduled communication on the network.
Max Unscheduled Address	The highest node number that you use on the network.
Media Redundancy	The ControlNet channels that you are using.
Network Name	A name for identifying the ControlNet network.

10. If you have repeaters or fibers, make the necessary selections in the Media Configuration tab.

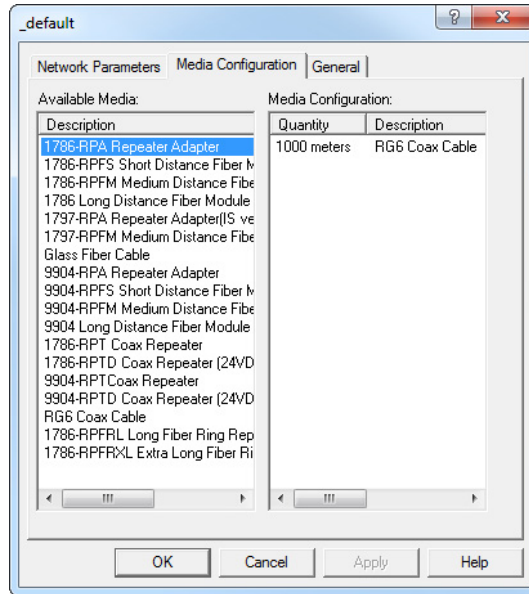

11. Click Apply.
12. Click OK.
13. From the Network menu, choose Single Pass Browse.
14. From the File menu, choose Save.
15. Type a name for the file that stores the network configuration, then click Save.
16. Click Optimize and rewrite Schedule for all Connections (default) and click OK.

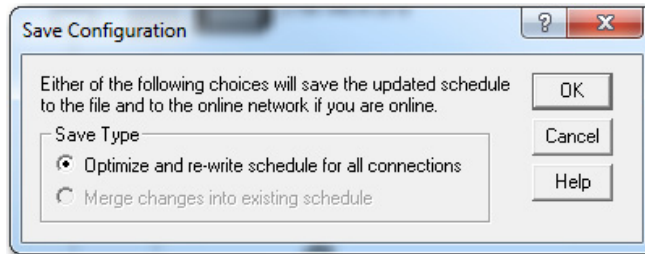

You have finished scheduling your new ControlNet network.

Update an Existing Scheduled Network

If you are adding the redundant chassis to an existing ControlLogix system that uses a ControlNet network, complete these steps to update the existing ControlNet network.

1. Turn on the power to each chassis.
2. Start RSNetWorx for ControlNet software.
3. From the File menu, choose Open.
4. Select the file for the network and click Open.
5. From the Network menu, choose Online.
6. From the Network menu, choose Enable Edits.

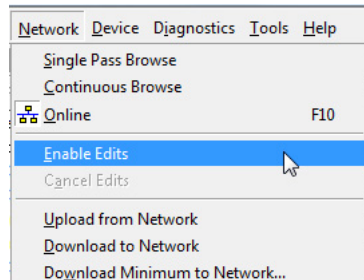

7. From the Network menu, choose Properties.
8. In the Network Parameters tab, update the parameters specific to your system.

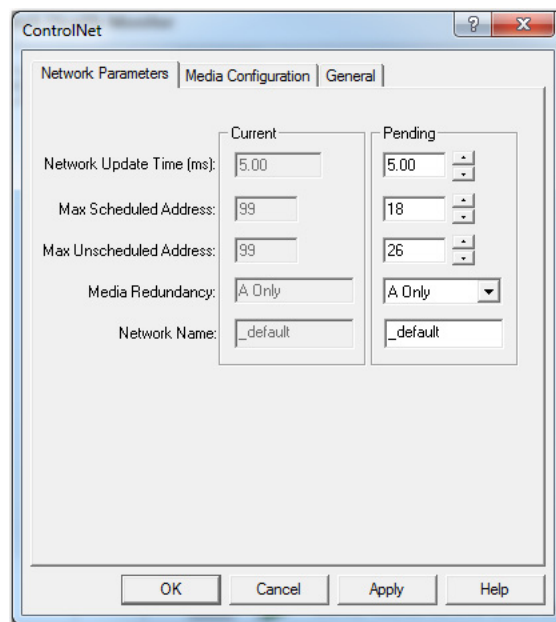

9. Click OK.
10. From the Network menu, choose Single Pass Browse.
11. From the File menu, choose Save.

- Click Optimize and rewrite schedule for all connections and click OK.

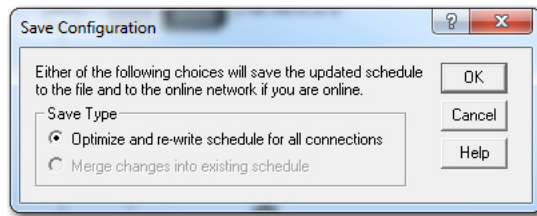

- Click OK.

You have completed updating your scheduled ControlNet network.

Check the Network Keeper States

After you schedule your ControlNet network, check the states of keeper-capable nodes. Checking the status of keeper-capable nodes is important because if a major network disruption occurs, the keepers provide network configuration parameters that are required to recover.

For more information about keepers and their function in a ControlNet network, see the ControlNet Network Configuration User Manual, publication [CNET-UM001](#).

To check the status of keepers on the ControlNet network, complete these steps.

- In RSNetWorx for ControlNet software, from the Network menu choose Keeper Status.

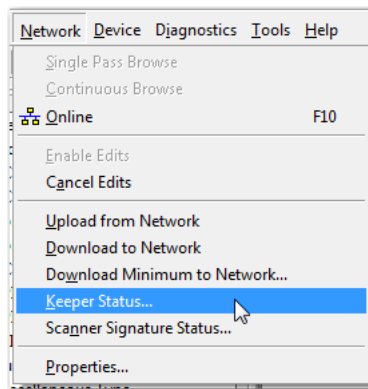

- Verify that one keeper-capable device outside the redundant chassis is indicated as active and valid.

3. Verify that all keeper-capable devices on the network are valid.

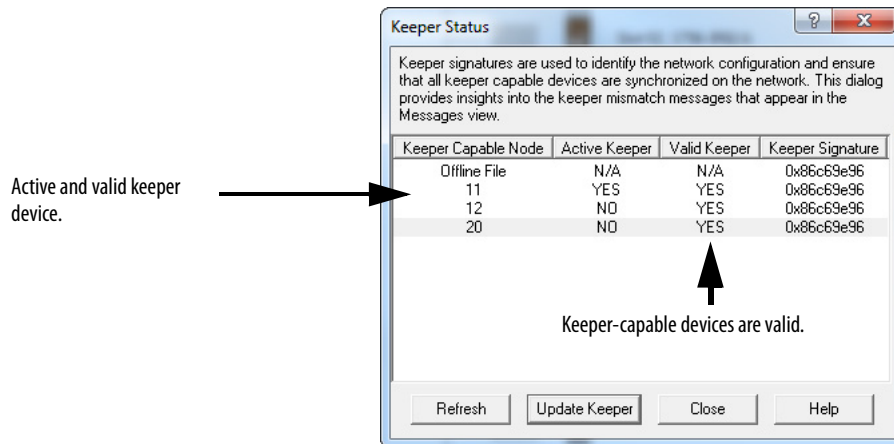

4. Verify that all nodes on the network have the same keeper signature.

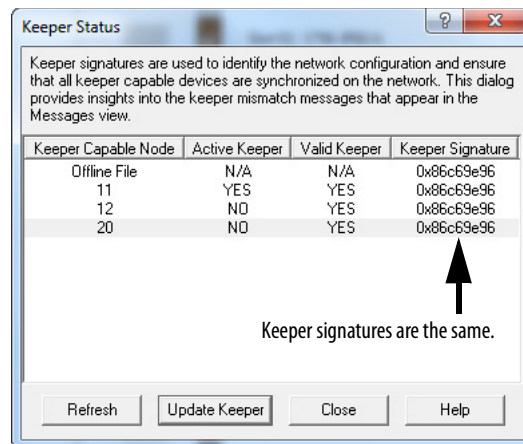

TIP If the keeper signatures of partnered ControlNet modules are different, your redundant chassis can fail to synchronize.

If the keeper signatures of your partnered ControlNet modules are different, update the keepers of the redundant ControlNet modules.

Save the Project for Each Primary Controller

After you have scheduled your ControlNet networks, go online with each controller in your primary chassis and save the project. This process makes downloading a project easier in the future because you won't be required to reschedule the network after completing the download.

Automatic Keeper Crossloads

The 1756-CN2/B, 1756-CN2R/B, and 1756-CN2RXT ControlNet modules have an Automatic Keeper Crossload feature that makes replacing a ControlNet module in a redundant chassis easier. The Automatic Keeper Crossload feature also reduces the need to use RSNetWorx for ControlNet software once the system is running.

With the Automatic Keeper Crossload feature, ControlNet modules can automatically upload the keeper signature and network parameters from the active keeper of a ControlNet network.

To replace a ControlNet module that has been configured and scheduled on the ControlNet network, remove the existing module and insert a 1756-CN2/B, 1756-CN2R/B, or 1756-CN2RXT module. The module that you are inserting must be unconfigured or have a keeper signature of all zeros.

TIP To clear the keeper signature of a 1756-CN2, 1756-CN2R, or 1756-CN2RXT module, complete these steps.

1. Disconnect the module from the ControlNet network and remove it from the chassis.
2. Set the node address switches to 00.
3. Insert the module back into the chassis and wait for the status display to indicate Reset Complete.
4. Remove the module and set the node address switches to the intended node address.
5. Insert the module into the chassis.

After being inserted and connected to the ControlNet network, the unconfigured 1756-CN2, 1756-CN2R, and 1756-CN2RXT modules crossload the appropriate configuration from the active keeper on the ControlNet network. The modules then become configured with the appropriate keeper signature.

Configure the Redundancy Modules

Topic	Page
About the Redundancy Module Configuration Tool (RMCT)	89
Determine If Further Configuration Is Required	90
Use the RMCT	91
Module Info Tab	94
Configuration Tab	96
Synchronization Tab	99
Synchronization Status Tab	102
System Update Tab	103

About the Redundancy Module Configuration Tool (RMCT)

The Redundancy Module Configuration Tool (RMCT) is used to configure the redundancy modules and to determine the status of the redundancy system.

Use the RMCT to complete these configuration-related tasks:

- Set Auto-Synchronization parameters.
- Set the time and date of redundancy modules.
- View and set module information.
- View and set Chassis ID parameters (Chassis A, Chassis B).
- Lock the redundant system for an update.
- Conduct a test switchover.

You can also use this functionality available with the RMCT to determine the status of the redundant system:

- View error diagnostics specific to redundant chassis.
- View qualification and compatibility status of partnered modules.
- Identify noncompliant modules for removal.
- View redundant system event history.

Determine If Further Configuration Is Required

The default configuration of the redundancy modules lets you synchronize your redundant chassis without additional configuration if you are using a basic redundant chassis pair.

However, some applications and uses of the redundancy system can require additional configuration. For example, you must use the RMCT for additional configuration if you must complete any of these tasks:

- Set the redundancy modules to another time or date (recommended).
- Program your controller to control the redundant system.
- Change the redundancy synchronization options of the redundant system.
- Change the synchronization states of your redundant chassis.
- Conduct a test switchover.
- Complete a firmware update of a module in the redundant chassis while the system is online.

If you must complete any of these tasks, see the sections that follow.

Use the RMCT

To access and begin using the RMCT, launch RSLinx® Classic software and browse to your redundancy module. Right-click the redundancy module and choose Module Configuration.

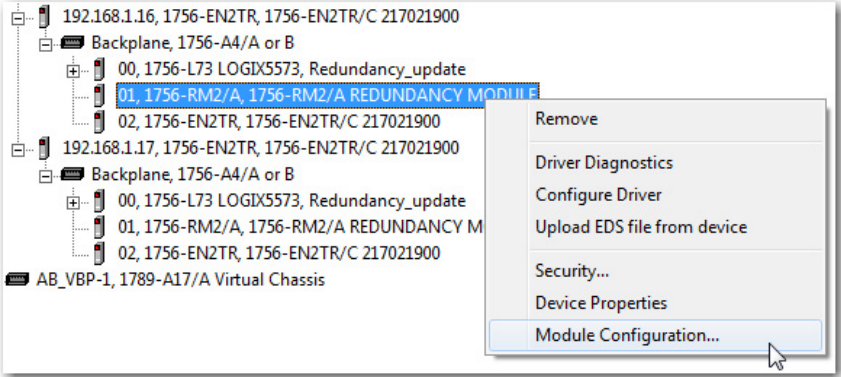

TIP If you cannot see the Module Configuration option in the list, then the compatible version of the RMCT is not installed.

When you access the RMCT, the dialog box always indicates the status of the redundancy chassis in the bottom-left corner.

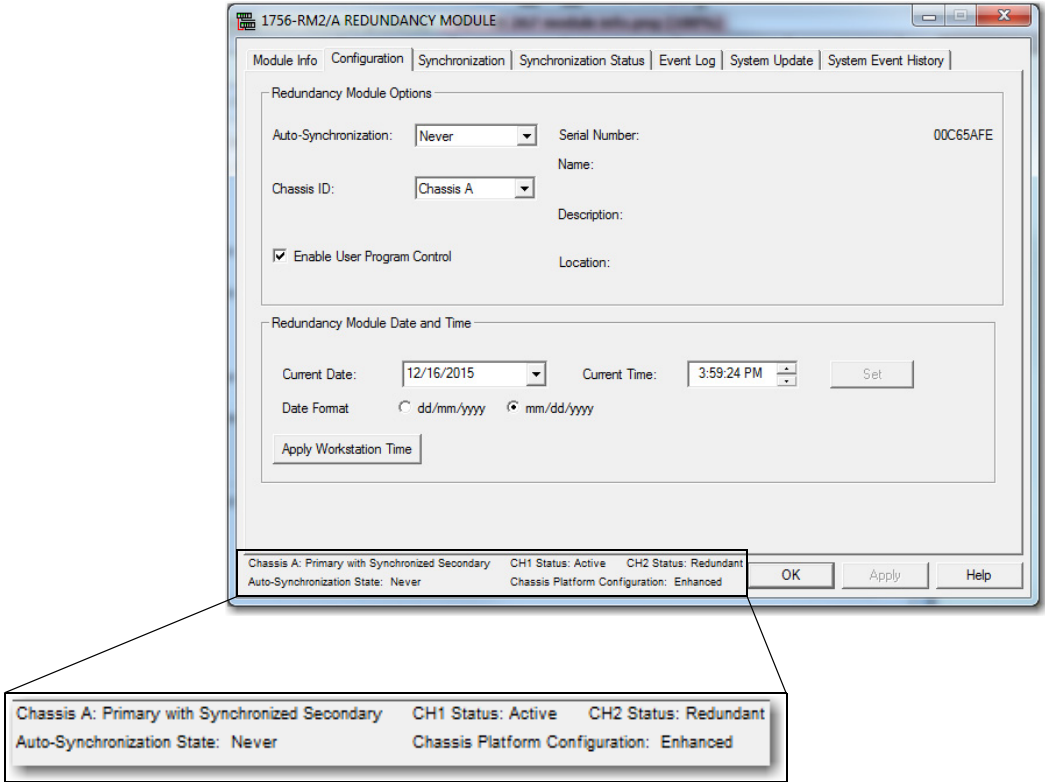

Identify the RMCT Version

You must use a version of the RMCT that is compatible with your redundancy module firmware.

Beginning with version 20.054, the redundancy module firmware reports back to the Redundancy Module Configuration Tool (RMCT) as to which version of the RMCT is compatible. If there is an incompatibility, the RMCT shows only the Module Info tab and indicates the version that the firmware is compatible with.

For a version earlier than 20.054, go to the Tech Support website at <http://www.rockwellautomation/support.com> to determine which RMCT version is required for use with your redundancy module firmware revision.

To find the latest firmware bundle on the website, follow these steps.

1. Once on the site, choose Control Hardware.
2. On the Firmware Updates page, choose the latest firmware bundle.
3. Download if different from the firmware of your module.

Complete these steps to check or verify the version of the Redundancy Module Configuration Tool (RMCT) that you have installed.

TIP The RMCT launches at the version that is compatible with the 1756 redundancy module firmware that is installed.

If you have not updated your 1756 redundancy module firmware after upgrading your RMCT version, the RMCT version that is indicated can differ from version you updated to. You can also check the RMCT version that you have installed by using Add or Remove Programs in the Control Panel.

1. Launch RSLinx Classic software.
2. Click the RSWho icon.



- 3. Right-click your redundancy module and choose Module Configuration.

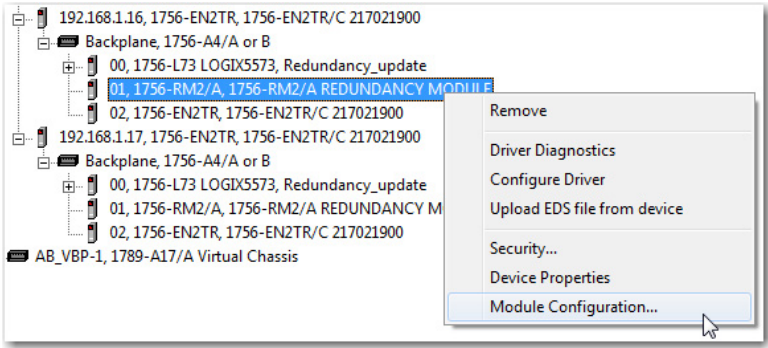

The Module Configuration dialog box opens.

- 4. Right-click the title bar and choose About.

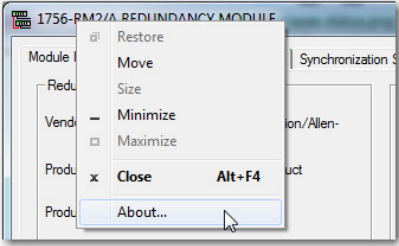

The About dialog box opens and indicates the RMCT version.

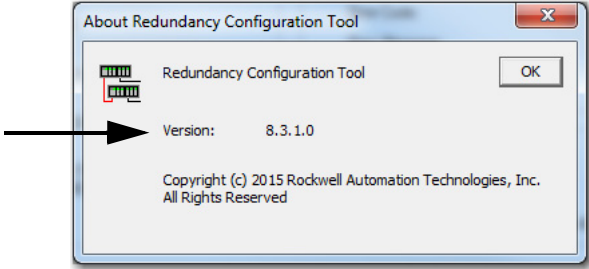

This should show the version you need based on your bundle or higher. The RMCT always shows the latest version installed, and later versions are backwards compatible with earlier versions.

Update the RMCT Version

The RMCT version that is compatible with your redundancy module firmware is packaged with the redundancy system firmware bundle. To launch the installation of the RMCT, open the folder that contains the redundancy firmware revision and double-click the executable file titled Redundancy_Module_CT.exe.

TIP RMCT version 8.2.1 and later can be downloaded and installed separately.

The RMCT Installation Wizard opens and prompts you with the steps to install the RMCT.

Module Info Tab

The Module Info tab of the RMCT provides a general overview of the identification and status information of the redundancy module. This status information is updated approximately once every two seconds.

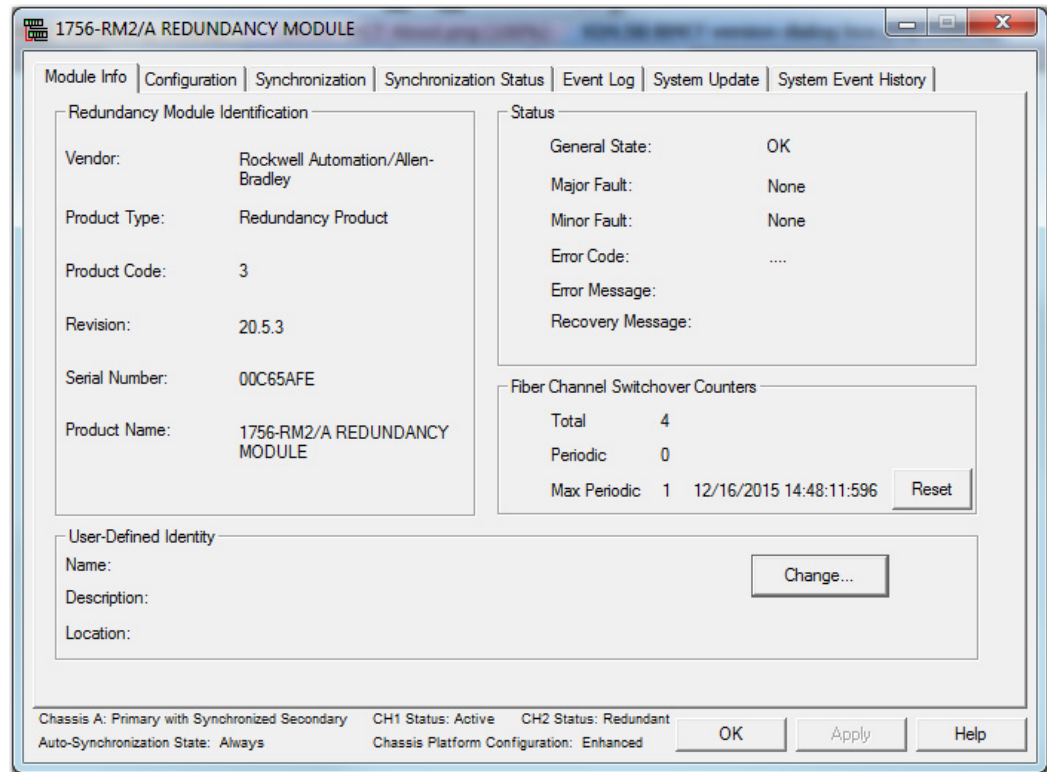

TIP Not all indicators are shown for 1756-RM/A and 1756-RM/B modules.

These parameters are indicated in the Module Info tab.

Table 7 - Module Info Tab - Parameters Indicated

Parameter	Description
Vendor	Name of the vendor of the redundancy module.
Product Type	General product type of the redundancy module.
Product Code	CIP™ product code for the redundancy module.
Revision	Major and minor revision information for the redundancy module.
Redundancy Module Serial Number	Serial number of the redundancy module.
Product Name	Predefined catalog name of the redundancy module.
General Status	General state of the redundancy module. Possible values include Startup, Load, Fault, and OK.
Major Fault	The major fault status of a redundancy module. When a major fault is detected, the system does not provide redundancy support.
Minor Fault	The minor fault status of a redundancy module. When a minor fault is detected, the system continues to provide redundancy support.
Error Code	Error code that is related to the fault if one exists.
Error Message	Text-based message that describes the error if a fault exists.
Recovery Message	Text-based message that indicates the recovery from a fault.
Total	Indicates the number of channel switchovers that have occurred from CH1 to CH2 and vice versa on the module since its last powerup. It is reset to 0 automatically by firmware on a power cycle.
Periodic	Indicates the number of switchovers that have occurred between CH1 and CH2 over the last 10-second interval. The counter is constantly updated to reflect the value that is recorded at every 10-second interval. The counter is automatically reset to 0 on a power cycle.
Max Periodic Switchovers	The maximum number that is recorded in the Periodic counter. The time of the update is recorded every time that the counter is updated. The counter is automatically reset to 0 on a power cycle and can also be reset by clicking the Reset button. ⁽¹⁾
CH1 Status	Fiber Channel 1 status. The status shows the operating condition of the respective fiber channels in terms of one of the following values: <ul style="list-style-type: none"> – Unknown - Operating state is not yet determined – Active - Channel is operating normally as the ACTIVE channel – Redundant - Channel is operating normally as the REDUNDANT channel – Link Down - Channel is disconnected. Causes can be: the cable is disconnected/broken/damaged; signal is attenuated, connector is loose, the partner 1756-RM2 module is power down or in a major fault state – No SFP - No transceiver was detected, it has failed, it is loosely connected, it is not installed – SFP !Cpt - Transceiver is not a Rockwell Automation supported unit – SFP Fail - Transceiver is in a failed state
CH2 Status	Fiber Channel 2 status. See CH1 Status on page 95 .
Chassis Platform Configuration	Indicates configuration (version 19.05x and later always displays 'enhanced').

(1) The Periodic counters can be used to identify a burst of switchovers that can take place due to intermittent channel failures within a few seconds. The recorded time can be helpful to correlate the switchover occurrences with any external failures that have occurred on the fiber cables.

In addition, you can click Change to edit the User-Defined Identity parameters to meet your application needs.

Configuration Tab

Use the Configuration tab to set redundancy options and the internal clock of the redundancy module. After you modify a parameter, the Apply Workstation Time button becomes active.

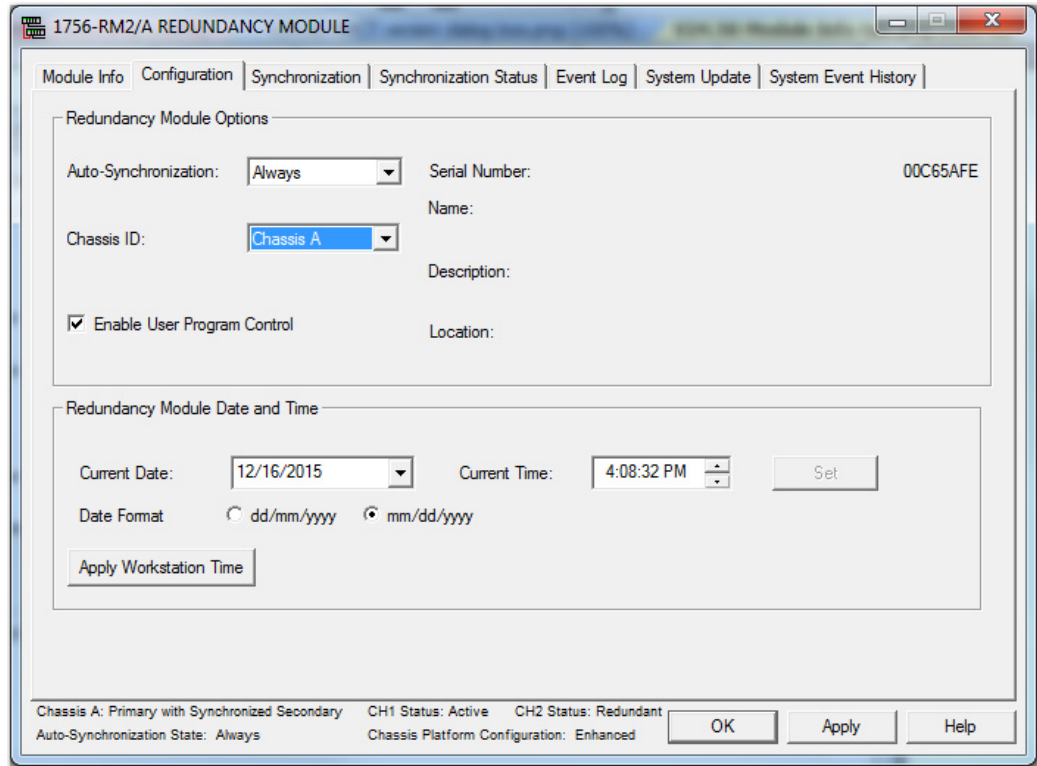

Auto-synchronization

The first parameter in the Configuration tab is the Auto-Synchronization parameter. The value that you chose for this parameter determines a significant part of your redundant system behavior.

TIP Verify that your Auto-Synchronization parameter is at the proper value **before** you modify your redundant system. This verification helps prevent system errors.

For example, if you are upgrading your redundant system firmware, verify that this parameter is set to Never or Conditional before disqualifying your secondary chassis. If this parameter is Always, you cannot properly disqualify your chassis and conduct the update.

Use the following table to determine the Auto-Synchronization setting that best suits your application.

If you use this parameter	This synchronization behavior results
Never	<p>The system remains in the same state, that is, either synchronized or disqualified, until one of these events takes place:</p> <ul style="list-style-type: none"> • A command is issued from the RMCT to either synchronize or disqualify. • The controller commands synchronization or disqualification by using a MSG instruction. For this action to occur, Enable User Program Control must be checked. • A fault on the primary causes a switchover.
Always	<p>The system automatically synchronizes regularly.</p> <p>If you attempt to disqualify the system by using the Disqualify Secondary command in the RMCT, the resulting disqualification is temporary as the system automatically qualifies and synchronizes again.</p> <p>If the controller program disqualifies the system, the resulting disqualification is also temporary.</p>
Conditional	<p>The system behavior with this setting is dependent on the Auto-Synchronization state of your system, found in the lower left portion of the RMCT window after setting the Auto-Synchronization parameter to Conditional:</p> <ul style="list-style-type: none"> • If your Auto-Synchronization parameter is set to Conditional and your Auto-Synchronization state is 'Conditional, Enabled', then the system continually attempts to synchronize. • If your Auto-Synchronization parameter is set to Conditional and your Auto-Synchronization state is 'Conditional, Disabled', then the system does not automatically attempt to synchronize. <p>To change from 'Conditional, Enabled' to 'Conditional, Disabled', click Disqualify Secondary on the Synchronization tab.</p> <p>To change from 'Conditional, Disabled' to 'Conditional, Enabled', click Synchronize Secondary on the Synchronization tab.</p>

Chassis ID

The chassis ID parameter is used to assign a generic label to the chassis that house the redundancy modules. The available chassis labels are Chassis A and Chassis B.

If you change the chassis label in the RMCT of the primary redundancy module, the secondary module and chassis are automatically assigned the other chassis label.

The chassis label that is assigned to the module remains associated with the same physical chassis, regardless of its primary or secondary control designation.

Enable User Program Control

Check Enable User Program Control in the Configuration tab if you plan to use MSG instructions in your controller program to initiate a switchover, change the redundancy module time, or synchronize.

If you leave Enable User Program Control unchecked, the redundancy modules do not accept any commands from the controller.

Redundancy Module Date and Time

The Redundancy Module Date and Time parameters can be applied separate from the Redundancy Module Options parameters. The time that is specified with these parameters is the time that the event logs reference when a redundant system event occurs.

To change the redundancy module time settings, use the pull-down menu or type your changes then click Set to implement time changes. Or, to set the time of the redundancy module to match that of the workstation, click Apply Workstation Time.

IMPORTANT We recommend that you set the redundancy module date and time when you commission a system. We also recommend that you periodically check the date and time settings to make sure that they match the settings of the controller.

If a power failure occurs on the redundant chassis, you must reset the date and time information of the redundancy modules. The modules do not retain those parameters when power is lost.

Synchronization Tab

The Synchronization Tab has commands for these options:

- Change the synchronization state of the system (synchronize or disqualify)
- Initiate a switchover
- Force the disqualified secondary to become the primary

The commands are described in the [Commands in the Synchronization Tab](#) section on [page 100](#).

This tab also has information about the last four synchronization attempts in the Recent Synchronization Attempts log. N or N-X identify synchronization attempts in the log. If the redundant chassis fail to synchronize, a cause is identified in the Recent Synchronization Attempts log.

The causes and their interpretations are described in the [Recent Synchronization Attempts Log](#) section on [page 101](#).

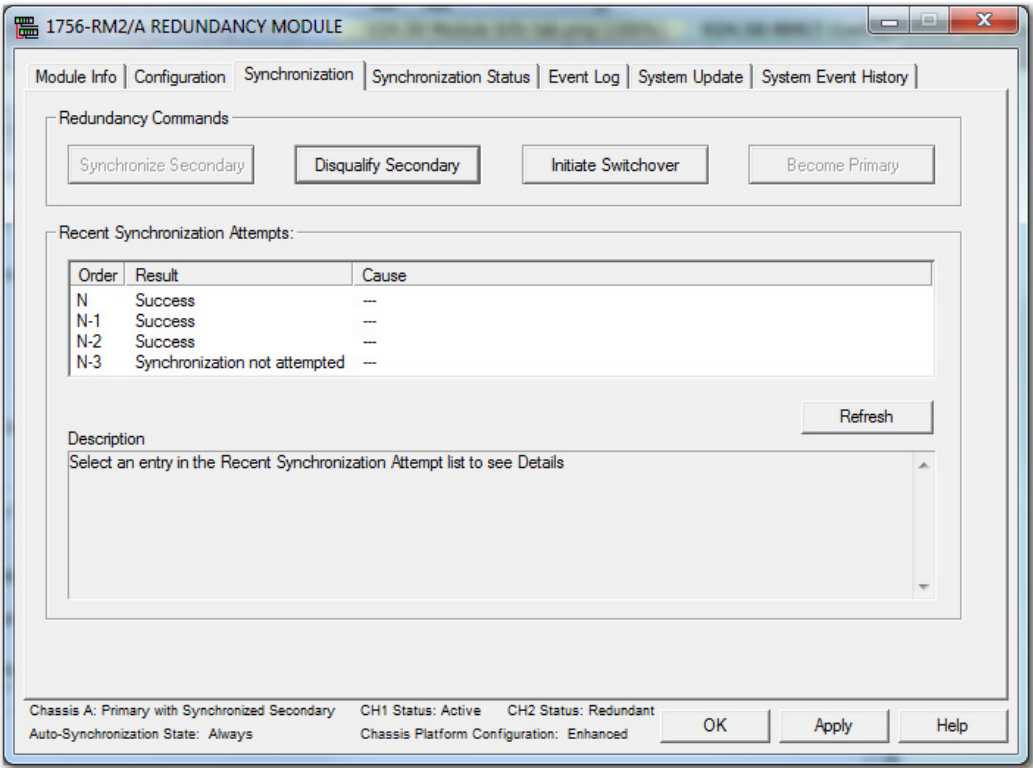

Commands in the Synchronization Tab

These sections explain each redundancy command and the system conditions that are required for the command to be available.

Command	Description
Synchronize Secondary	<p>This command forces the primary redundancy module to attempt synchronization with its partner. This command is available in specific conditions:</p> <ul style="list-style-type: none"> • Available only when the chassis redundancy state is as follows: <ul style="list-style-type: none"> – Primary with Disqualified Secondary – Disqualified Secondary • Unavailable (dimmed) in all other chassis states <p>Synchronization is asynchronous with the execution of this command. Successful execution of this command begins with synchronization, which can take several minutes. Monitor the chassis status that is displayed at the bottom of the RMCT to determine when synchronization has completed.</p>
Disqualify Secondary	<p>This command forces the primary redundancy module to disqualify its partner.</p> <hr/> <div style="display: flex; align-items: center;">  <div> <p>ATTENTION:</p> <ul style="list-style-type: none"> • Disqualifying the secondary chassis makes it unable to assume control functions, that is, redundancy is lost. • If you disqualify the secondary and a major fault occurs on the remaining primary, a switchover does not occur. </div> </div> <hr/> <p>This command is available in specific conditions:</p> <ul style="list-style-type: none"> • Available only when the chassis redundancy state is as follows: <ul style="list-style-type: none"> – Primary with Synchronized Secondary – Synchronized Secondary • Unavailable (dimmed) in all other chassis states <p>If you use the Disqualify Secondary command when the Auto-Synchronization parameter is set to Always, a synchronization attempt occurs immediately after the secondary chassis becomes disqualified.</p> <p>To keep the secondary disqualified after issuing a Disqualify Secondary command, set the Auto-Synchronization parameter to Conditional or Never before disqualifying the secondary.</p>
Initiate Switchover	<p>This command forces the system to initiate an immediate switchover from the primary chassis to the secondary chassis. This command can be used when you upgrade redundancy system firmware or when you complete maintenance on one chassis of the redundant pair.</p> <p>This command can also be used to perform a realistic test of your redundant system behavior by simulating a failure that is detected in the primary control chassis.</p> <p>This command is available in specific conditions:</p> <ul style="list-style-type: none"> • Available only when the chassis redundancy state is as follows: <ul style="list-style-type: none"> – Primary with Synchronized Secondary – Synchronized Secondary • Unavailable (dimmed) in all other chassis states
Become Primary	<p>This command forces a disqualified secondary system to become a primary system and is available in specific conditions:</p> <ul style="list-style-type: none"> • Available only when the chassis redundancy state is Secondary with No Primary. • Unavailable (dimmed) in all other chassis states

Recent Synchronization Attempts Log

This table describes the possible result and causes of synchronization states.

Table 8 - Recent Synchronization Attempts Log - Result Interpretations

Result	Result Interpretation
Undefined	The result of the synchronization is unknown.
No attempt since last powerup	Synchronization has not been attempted since power was applied to the module.
Success	Full synchronization was successfully completed.
Abort	The synchronization attempt failed. See Table 9 for further information.

If the Synchronization Attempts log indicates that the Synchronization attempt was aborted, use [Table 9](#) to diagnose the cause.

Table 9 - Synchronization Interpretation

Cause	Cause Interpretation
Undefined	The cause of synchronization failure is unknown.
Module Pair Incompatible	Synchronization was aborted because one or more module pairs are incompatible.
Module Configuration Error	Synchronization was aborted because one of the modules is improperly configured.
Edit Session In Progress	Synchronization was aborted because an edit or session is in progress.
Crossloading Failure	An undetermined failure occurred during synchronization between redundancy modules.
Comm Disconnected	The cable between the redundancy modules was disconnected.
Module Insertion	Synchronization was aborted because a module was inserted into a chassis.
Module Removal	Synchronization was aborted because a module was removed from a chassis.
Secondary Module Failed	Synchronization was aborted because of a failure in the secondary module.
Incorrect Chassis State	Synchronization was aborted due to an incorrect chassis state.
Comm Does Not Exist	Synchronization could not be performed because the communication link between redundancy modules does not exist.
Non-redundant Compliant Module Exists	Synchronization could not be performed because one or more non-redundancy modules are present in one of the chassis.
Sec Failed Module Exists	A module in the secondary chassis has asserted the SYS_FAIL line, which indicates that it has faulted or failed.
Local Major Unrecoverable Fault	Synchronization was aborted because of a local major unrecoverable fault.
Partner Has Major Fault	Synchronization was aborted because the partner module has a major fault.
Sec SYS_FAIL_L Subsystem Failed	The test of the SYS_FAIL line in the secondary chassis failed.
Sec RM Device Status = Comm Error	Synchronization was aborted because the status of the secondary redundancy module indicates a communication error.
Sec RM Device Status = Major Recoverable Fault	Synchronization was aborted because the status of the secondary redundancy module indicates a major recoverable fault.
Sec RM Device Status = Major Unrecoverable Fault	Synchronization was aborted because the status of the secondary redundancy module indicates a major unrecoverable fault.
Incorrect Device State	Synchronization was aborted because the device is in the wrong state.
Primary Module Failed	Synchronization was aborted because of a failure in the primary module.
Primary Failed Module Exists	A module in the primary chassis has asserted the SYS_FAIL line, which indicates that it has faulted or failed.
Auto-Sync Option	Synchronization was aborted because the Auto-Synchronization parameter of one of the redundancy modules was changed during synchronization.

Table 9 - Synchronization Interpretation

Cause	Cause Interpretation
Module Qual Request	Synchronization was aborted because another synchronization request was received. The current synchronization has stopped so that the new synchronization request can be serviced.
SYS_FAIL_L Deasserted	Synchronization was aborted because one of the modules came out of a faulted or failed state.
Disqualify Command	Synchronization was aborted because the redundancy module received a disqualify command from another device. The originating device sends this command when it can no longer perform in the qualified state.
Disqualify Request	Synchronization was aborted because the redundancy module received a disqualify command from another device. The originating device sends this command when it can no longer perform in the qualified state.
Platform Configuration Identity Mismatch Detected	There are modules in the primary or secondary chassis that do not belong to the platform.
Application Requires Enhanced Platform	A redundant controller is running an application that contains a feature that is qualified to run only on an enhanced redundant platform, for example, Alarms.
ICPT Asserted	A test line on the backplane is asserted.
Unicast Not Supported	A unicast connection is configured in the redundant controller, and redundancy systems do not support Unicast.
PTP Configuration Error	The PTP clock of a redundant controller is not synchronized or the partner controller pair is synchronized to another Grandmaster.
Secured Module Mismatch	A mismatch was detected between a primary and secondary secured module.

Synchronization Status Tab

The Synchronization Status tab provides a module-level view of these items:

- Synchronization state (for example, Synchronized or Disqualified)
- Chassis designation (Primary or Secondary)
- Module compatibility with its partner (for example, Full or Undefined)

Each module that is installed in the chassis is identified and information regarding its partner and compatibility are provided.

Slot	% Complete	Module Name	Module Revision	Secondary Readiness	State	Compatibility
0	100	DB_1756-L73/A INT_7xR...	24.50	Synchronized	Primary	Full
1	100	1756-RM2/A REDUNDAN...	20.5	Synchronized	Primary	Full
2	100	1756-EN2TR/C 217021900	10.7	Synchronized	Primary	Full
3	---	<empty>	---	---	---	---

System Update Tab

Use of the commands in the System Update tab lets you perform firmware updates in the secondary chassis while the primary chassis remains in control. Reference the lock and switchover logs in this tab for update information when completing a firmware update.



ATTENTION: When performing firmware updates by using commands in the System Update tab, redundancy is lost. In the event of a fault on the operating primary chassis, the system cannot switchover control to the secondary chassis.

1756-RM2/A REDUNDANCY MODULE

Module Info | Configuration | Synchronization | Synchronization Status | Event Log | System Update | System Event History

System Update Commands

Lock For Update Abort System Lock Initiate Locked Switchover

System Update Lock Attempts

System Lock History	Initiation Time	Status	Result
N	---	Not attempted	---
N-1	---	Not attempted	---
N-2	---	Not attempted	---
N-3	---	Not attempted	---

Locked Switchover Attempts

Locked Switchover History	Initiation Time	Status	Result
N	---	Not attempted	---
N-1	---	Not attempted	---
N-2	---	Not attempted	---
N-3	---	Not attempted	---

Refresh

Chassis A: Primary with Synchronized Secondary CH1 Status: Active CH2 Status: Redundant
 Auto-Synchronization State: Always Chassis Platform Configuration: Enhanced

OK Apply Help

System Update Commands

The three system update commands are available only when accessing a primary redundancy module. These commands are not available when accessing the secondary redundancy module.

TIP While you are completing tasks to update the system by using the system update commands, you cannot access these tabs in the RMCT:

- Configuration
- Synchronization
- Synchronization Status

If you attempt to access any of these tabs while the system is locked or is completing a locked switchover, it results in an error dialog box.

Lock For Update

The Lock for Update command lets you synchronize a redundant chassis pair under these conditions:

- The secondary redundancy module uses updated firmware and an updated programming software application program version.
- The running primary redundancy module uses a previous firmware revision and previous programming software application program version.

The Lock for Update command is available only when all modules in the primary chassis have no compatibility anomalies. Before issuing the lock command, verify that you have completed these tasks:

- Set the Auto-Synchronization option in the Configuration tab to Never.
- Disqualify the secondary chassis by using the Disqualify Secondary command in the Synchronization tab of the RMCT of the secondary redundancy module.
- Updated the primary and secondary redundancy modules to compatible firmware revisions.
- Updated all other modules in the secondary chassis to their intended firmware revisions.
- Configured the controller project that as required to accommodate the update and replacement of modules if needed.

For details about how to complete those tasks, see [Update Redundant Firmware on page 58](#).

Click the Lock for Update command to initiate the locking process. The lock can take several minutes to finish. Monitor the System Update Lock Attempts log to determine when the lock is complete. In addition, the chassis status that is shown at the bottom-left of the dialog box changes from Primary with Disqualified Secondary to Primary Locked for Update.

Figure 23 - Lock for Update Status Updates

Lock initiated.

System Update Lock Attempts			
System Lock History	Initiation Time	Status	Result
N	12/16/2015 16:16:848	In Progress	Lock for update initiated at :12/16/2015 16:16:8



Lock complete.

System Update Lock Attempts			
System Lock History	Initiation Time	Status	Result
N	12/16/2015 16:16:848	Locked	System locked at :12/16/2015 16:16:498

Lock complete.

Chassis A: Primary **Locked For Update**

Abort System Lock

The Abort System Lock command can be used to stop the system lock. It is available as soon as a lock for update is initiated.

Click Abort System Lock to return the redundant chassis status to Primary with Disqualified Secondary. This action also causes the system update to stop and the program in the secondary controller to clear. If you click Abort System Lock, you must download the program to the secondary controller before reattempting a Lock for Update.

Initiate Locked Switchover

The Initiate Locked Switchover command is available only when the chassis redundancy state is Primary with Locked Secondary. That is, the Initiate Locked Switchover is available only after the lock for update is complete.

If you click Initiate Locked Switchover, your secondary chassis assumes control and becomes the new primary. The old primary is now the new secondary chassis and you can update the firmware of the modules in the new secondary chassis.

Figure 24 - Illustration of Switchover

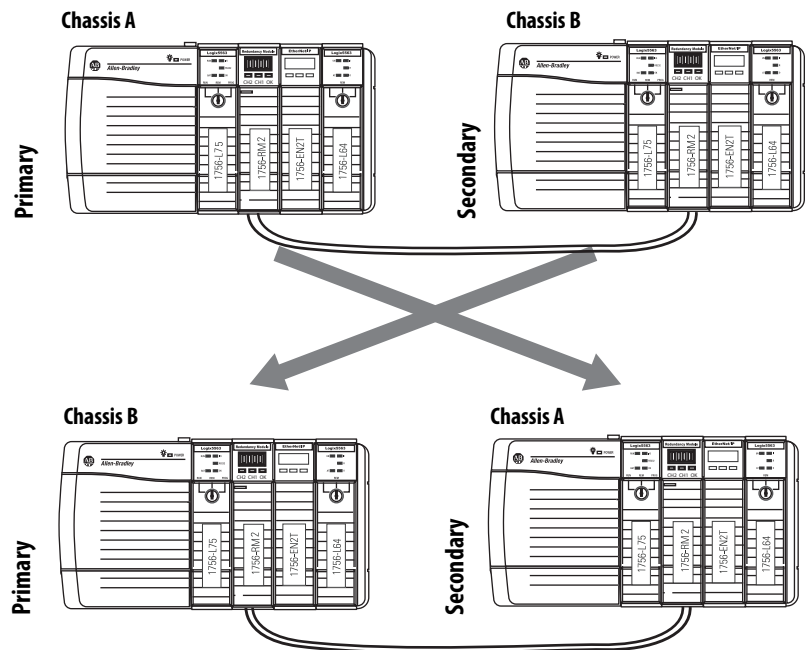

The difference between a locked switchover and a normal switchover is that you initiate the locked switchover. You or a fault in the primary chassis initiate a normal switchover.

System Update Lock Attempts

The System Update Lock Attempts is where attempts to lock the system are logged. This log displays the last four lock attempts and provides this information specific to each attempt:

- Time and date
- Status (for example, Locked or Abort)
- Result (for example, System Locked or Invalid Response Received)

The status indicated in the System Update Lock Attempts log can be any one of the states that are listed in [Table 10](#).

Table 10 - System Update Lock Attempts Log Statuses

Status	Interpretation
Not Attempted	A system lock has not been attempted since the last powerup.
In Progress	A lock is in progress.
Locked	The lock was successfully completed.
Abort	The lock attempt failed. The reason for the failure is indicated in a Result field.

If your status is indicated as Abort, one of these conditions can exist:

- An error occurred while communicating with the partner redundancy module.
- A module in the secondary chassis does not have a partner in the primary chassis.
- A module pair is incompatible.
- The SysFail test was unsuccessful in the primary redundancy module.
- A Major Recoverable Fault occurred in primary redundancy module.
- A Major NonRecoverable Fault occurred in primary redundancy module.
- A module was inserted into the chassis.
- A module was removed from the chassis.
- A failed module exists in the secondary chassis.
- A failed module exists in the primary chassis.
- An Abort System Update command received.
- Invalid response was received from a module.
- A module rejected the state change.
- A platform mismatch was detected.

Locked Switchover Attempts

The Locked Switchover Attempts log provides information about the status of the last four locked switchover attempts. This log includes this information about each attempt:

- Time and date
- Status
- Result

The status indicated in the Locked Switchover Attempts log can be any one of the states that are listed in [Table 11](#).

Table 11 - Locked Switchover Event Log Statuses

Status	Description
Not Attempted	A locked switchover has not been attempted since the last powerup.
In Progress	A locked switchover is in progress.
Success	A locked switchover was successfully completed.
Abort	The locked switchover attempt failed. The cause of the failure is indicated in a Result field.

If a locked switchover is aborted, it can be because of the following:

- A module declined a locked switchover readiness request.
- An invalid response was received from the locked switchover readiness request.
- After an initiate switchover prompt, a module rejected the command.
- After an initiate switchover prompt, a module replied with an invalid response.

Program the Redundant Controller

Topic	Page
Configure the Redundant Controller	109
Crossloads, Synchronization, and Switchovers	113
Crossloads and Scan Time	118
Program to Minimize Scan Times	120
Program to Maintain Data Integrity	127
Program to Optimize Task Execution	131
Conduct a Test Switchover	136
Program Logic to Run After a Switchover	138
Use Messages for Redundancy Commands	139
Set the Task Watchdog	143
Download the Project	145
Store a Redundancy Project to Nonvolatile Memory	146
Online Edits	149

Configure the Redundant Controller

Both controllers in the ControlLogix® redundancy system operate by using the same program. You do not need to create a project for each controller in the redundant system.

To configure your controllers to operate in a redundant system, complete these steps.

1. Open or create a project for your redundant controller.
2. Access the Controller Properties dialog box for the controller.

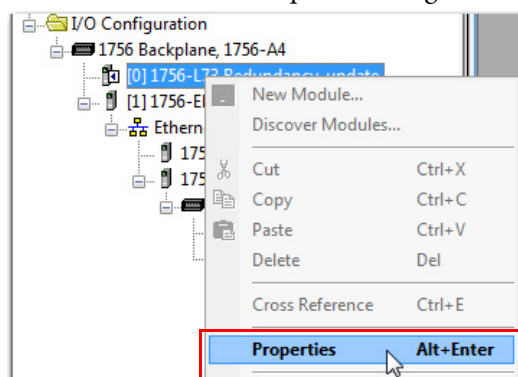

3. Click the redundancy tab and check Redundancy Enabled.

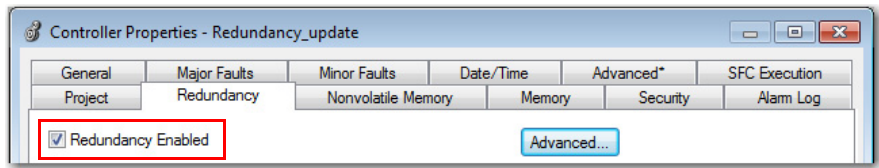

4. If you are going to complete edits to your redundant controller while online, see these sections for information about the parameters available in the Advanced settings:

- [Plan for Test Edits on page 150](#)
- [Reserve Memory for Tags and Logic on page 155](#)

5. Click the Advanced tab.

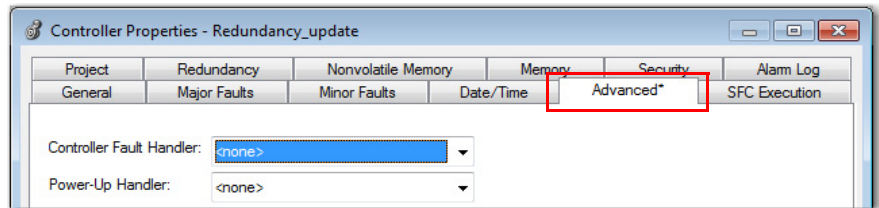

6. Verify that Match Project to Controller is unchecked.

IMPORTANT

Do not use Match Project to Controller property with redundant controllers.

If you use the Match Project to Controller property available in the Advanced tab of the Controller Properties dialog box, you cannot go online with, download to, or upload from the new primary controller after a switchover. This is because the serial number of the new primary controller is not the same as the serial number of the old primary controller and the project cannot be matched to the newly switched to controller.

Verify that this option is not checked. →

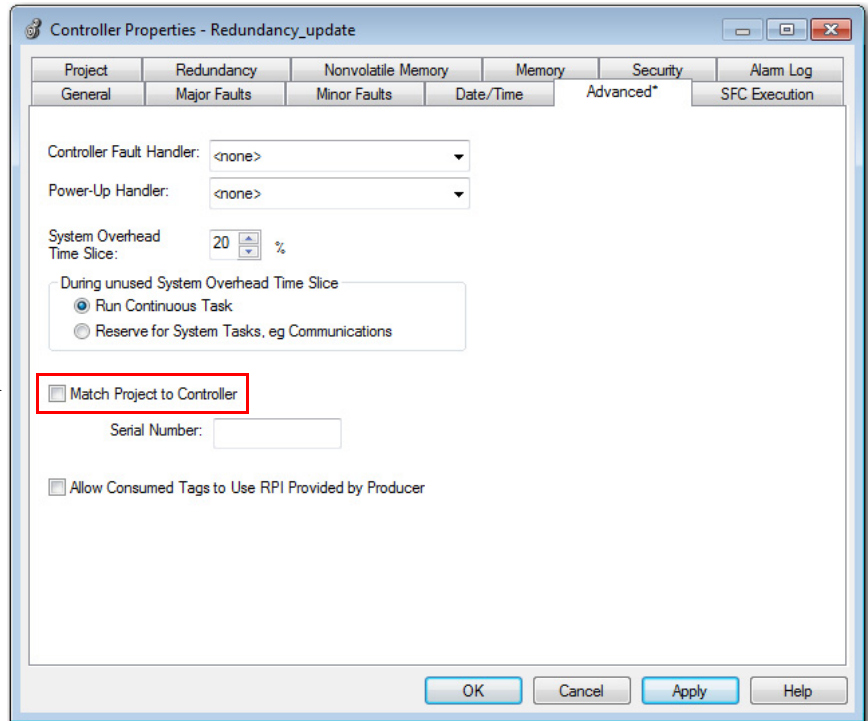

7. At the Date/Time tab in Controller Properties, make sure that Enable Time Synchronization is checked.

Verify that this option is checked. →

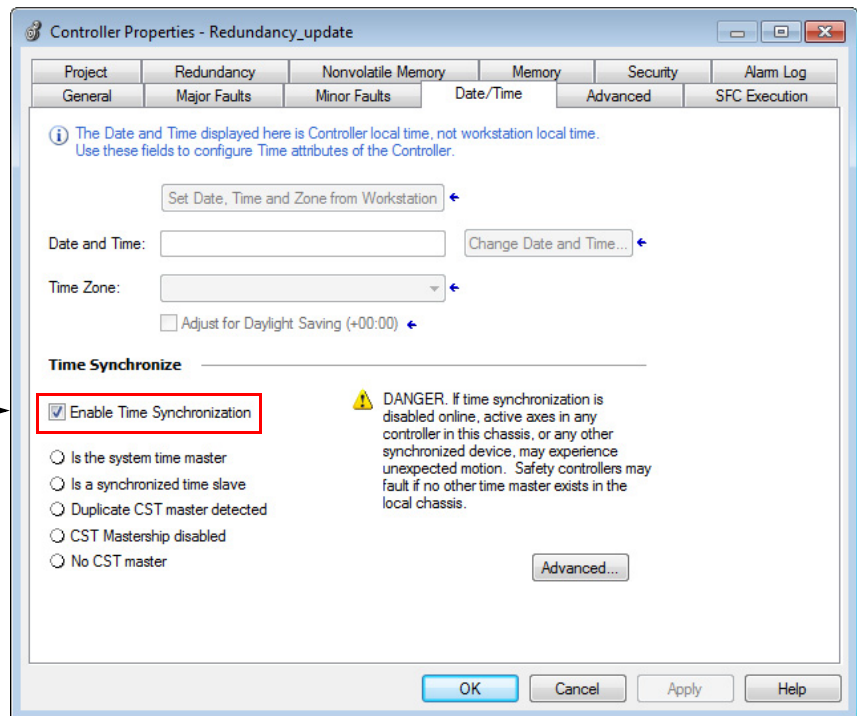

8. Click Apply.
9. Click OK.
10. Access the Module Properties dialog box for the Ethernet module.

- At the General tab of the Module Properties dialog box of the Ethernet module, click Change.

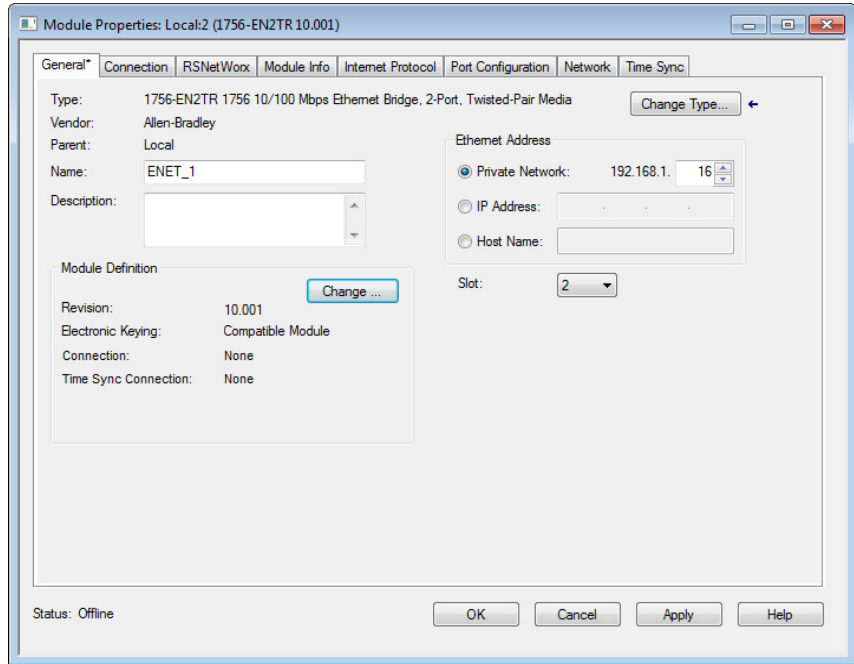

- In the Module Definition dialog box from the Time Sync connection pull-down menu, select Time Sync and Motion.

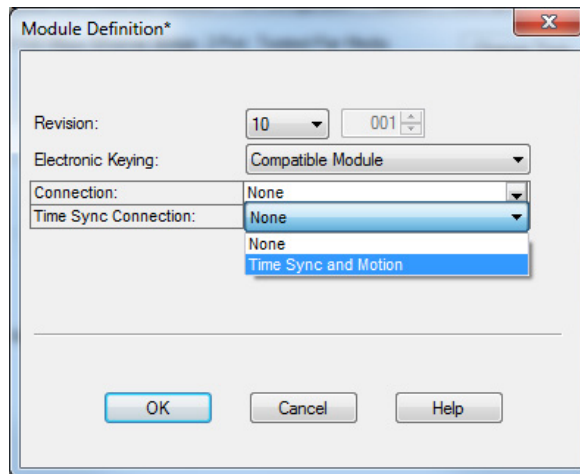

- Click OK to close the dialog box.
- At the warning dialog box, click Yes.
- Click Apply.
- Click OK to close the Module Properties dialog box.

You have completed the minimum configuration that is required for your redundant controllers.

Crossloads, Synchronization, and Switchovers

Crossloading and synchronization points are points where the primary controller transfers data to the secondary controller. Crossload and synchronization points keep the secondary controller ready to assume control in the event of a fault on the primary.

Before you begin programming your redundant controller, be aware of the impact of crossloads and synchronization on the execution of a program after a switchover. If you understand these concepts, it helps you to create programming that best meets the needs for your redundant application.

Continue reading the sections that follow for explanations of crossloads and synchronization and their relationship to switchovers and program execution.

Changing Crossload and Synchronization Settings

In the redundancy system, crossload and synchronization points for programs within the Studio 5000 Logix Designer® project are configurable. You can limit which programs data crossloading and synchronization follow. In many applications, changes to this setting can reduce the overall impact to the task scan time by reducing the number of times data is crossloaded.

If you reduce the number of crossload and synchronization points, the switchover time becomes longer. This increase in switchover time is because more programs can be rescanned after the switchover.

Synchronization is performed at the end of the last program in the program list of the task, regardless of the Synchronize Data after Execution setting for the program.

To change the synchronization setting of a program, open the Program Properties dialog box of the program and check or uncheck Synchronize Data after Execution.

Use this setting to change crossload and synchronization points.

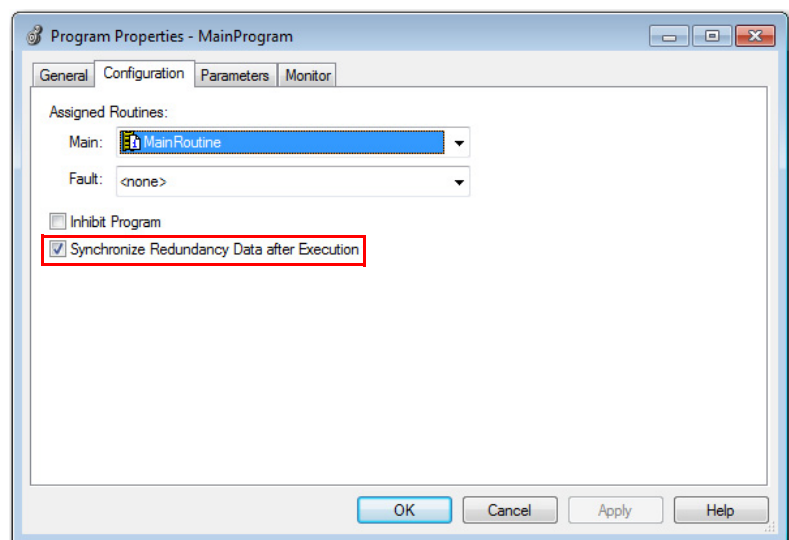
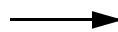

Default Crossload and Synchronization Settings

The default setting for a **program** in a redundant project is for a crossload to occur at the end of each program execution. However, for an **equipment phase**, the default is that the crossload not execute at the end of the phase.

Before you change the default crossload and synchronization settings, read the sections that follow so you have a complete understanding of the implications. For information about how to change the point in a task where a crossload occurs, see [Changing Crossload and Synchronization Settings on page 113](#).

Recommended Task Types

To avoid anomalies after a switchover occurs, we recommend that you use only one of these task configurations when programming your redundant controllers. Use either of the following:

- One continuous task
- Multiple periodic tasks, each with unique priorities and periods

Only the single highest-priority periodic task can ensure bumpless output switching on switchover. The sections that follow explain the impact of crossloads and synchronization after a switchover based on the task structure you use.

Continuous Task After Switchover

After a switchover occurs within a controller project that contains only a continuous task, the new primary begins executing at the last crossload and synchronization point. Depending on your crossload and synchronization setting, the program that the new primary controller begins with can be the following:

- The program that the switchover interrupted
- The program that immediately follows the last crossload and synchronization point

Continuous Task with Crossloads at Each Program End

This diagram demonstrates how programs set to crossload and synchronize at each program-end are executed after a switchover. As is shown, the new primary controller begins executing at the beginning of the program that the switchover interrupted. This process is the switchover execution that occurs if you use the default crossload and synchronization setting for a program.

Figure 25 - Program Execution After a Switchover (Crossload After each Program)

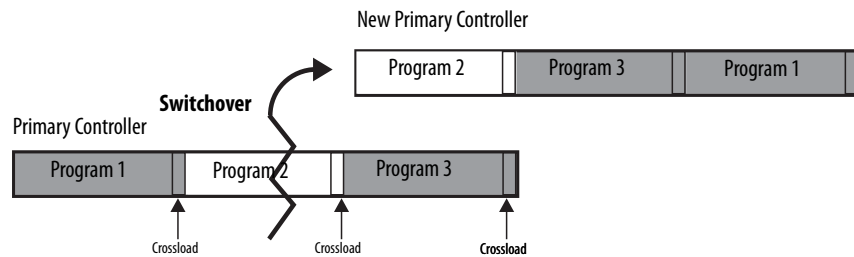

Continuous Task with Varying Crossloads at Program End

This diagram demonstrates how programs set to crossload and synchronize at various intervals are executed after a switchover. As is shown, the new primary controller begins executing the program that follows the last crossload and synchronization point.

Figure 26 - Program Execution After a Switchover (no Crossload After each Program)

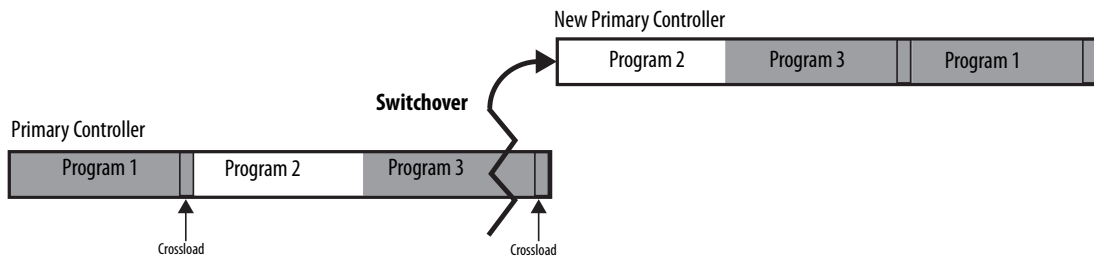

For information about how to change the point in a task where a crossload occurs, see [Changing Crossload and Synchronization Settings](#) on [page 113](#).

Multiple Periodic Tasks



ATTENTION: If you use multiple periodic tasks, program all crucial outputs within the highest-priority task. Failure to program outputs in the highest-priority task can result in outputs changing state if a switchover occurs.

In a project where multiple periodic tasks are used, the point where program execution begins after a switchover depends on the following:

- Crossload and synchronization settings
- Task priority settings

As with the continuous task, the controller begins executing at the program that follows the last crossload and synchronization point.

In addition, a higher priority task can interrupt a lower priority task. If a switchover occurs during or just after the higher priority task executes and the lower priority task has not been completed, then the lower priority task and programs are executed from the point at which the last crossload occurred.

This diagram demonstrates how tasks at different priorities execute if a switchover occurs while a lower priority task is executing. The crossload and synchronization points in this example are set to occur only at the end of the last program within the tasks. The points are not set to occur at the end of each program.

Figure 27 - Normal Periodic Task Execution (no switchover)

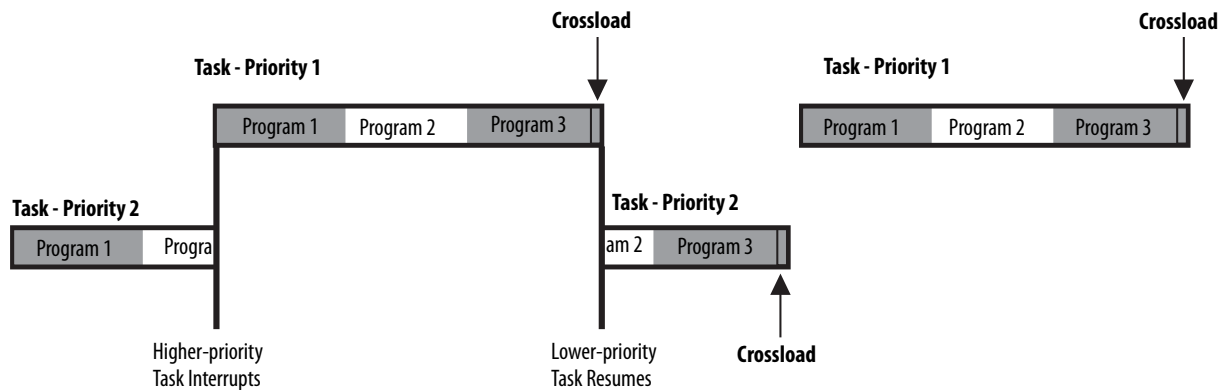

The following diagram shows a lower priority task that has not been completed and a switchover occurs. The lower priority task and programs are executed from the beginning of the program where the switchover occurred. This result is because the program uses the default configuration and crossloads and synchronization points occur at the end of each program.

Figure 28 - Periodic Task Execution After Switchover When Configured to Crossload After Programs

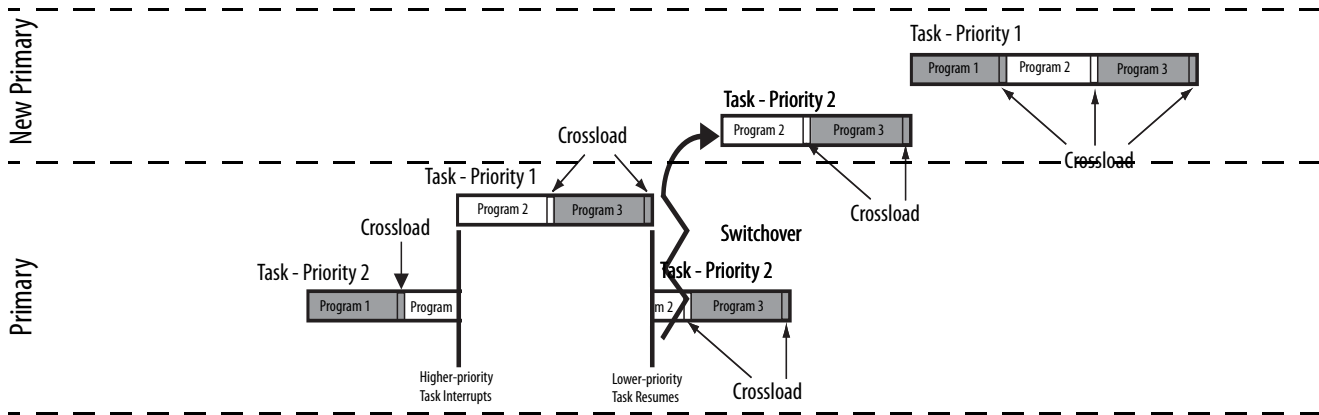

The following diagram shows a lower priority task that has not been completed and a switchover occurs. The lower priority task and programs are executed from the beginning and not at the program where the switchover occurred. This result is because the crossloads and synchronization points were not configured to occur at the end of each program.

Figure 29 - Periodic Task Execution After Switchover When Configured Not to Crossload After Programs

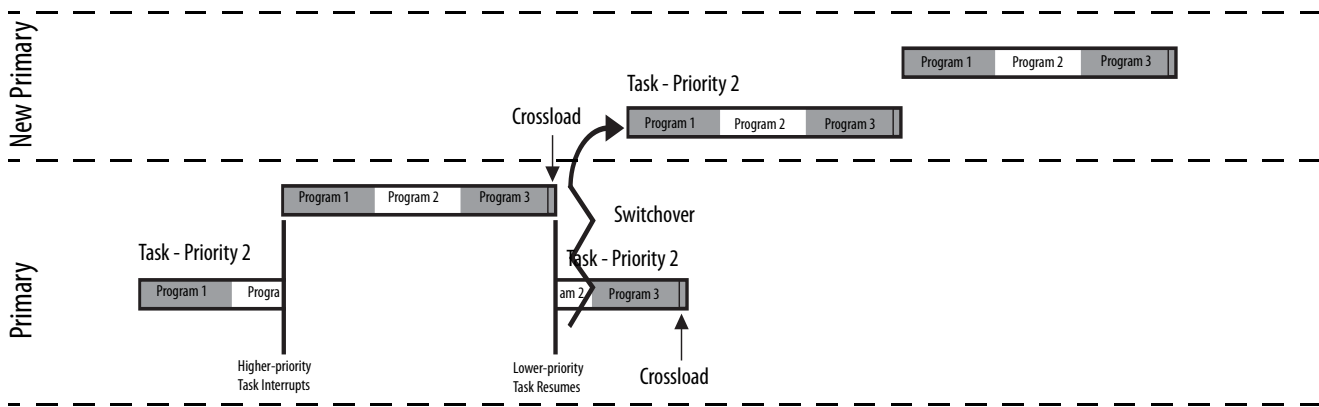

For more information about programs and tasks with controllers, see the Logix 5000 Controllers Tasks, Programs, and Routines Programming Manual, publication [1756-PM005](#).

Crossloads and Scan Time

It is important to plan for controller crossloads because the length of the crossloads affects the scan time of your program. A crossload is a transfer of data from the primary controller to the secondary controller. The crossload can occur at the end of each program or at the end of the last program in a task.

The scan time of your program or phase is a total of the program execution time and the crossload time. The following diagram demonstrates this concept.

Figure 30 - Crossload and Scan Time



Estimate the Crossload Time

The amount of time that is required for a crossload is primarily dependent upon the amount of data being crossloaded. During a crossload, any tag that has been written to during the program execution is crossloaded. Even if a tag has not changed, but has been rewritten during the program execution, it is crossloaded.

The crossload requires time to transfer tag value changes. The crossload also requires a small amount of overhead time to communicate information about the program being executed.

Redundancy Object Attributes for Crossload Times

Before you complete calculations to estimate the crossload time, you must use a Get System Value (GSV) instruction to read certain attributes of the redundancy object. These attributes are data transfer sizes that are measured in DINTs (4-byte words) and are used to calculate the estimated crossload time.

TIP To get these attributes, you do not need to have the secondary chassis installed or operating. If you do not have the secondary chassis operating, the attribute values read indicate what data sizes would be transferred if the secondary chassis was in use.

This table indicates the two attributes that you can choose to get specific to the crossload data transfer size. Get the attribute value that meets your application requirements.

If you need the	Then get this attribute value
Data size of the last data that is transferred during the last crossload	LastDataTransferSize
Data size of the largest crossload of data	MaxDataTransferSize

Remember that the LastDataTransferSize attribute refers to the transfer size of the **previous** crossload and synchronization point, which occurred before the program that contains the GSV instruction.

If you must measure the crossloaded data from the last program in the program list of the task, add an additional program at the end of the task that acquires the LastDataTransferSize value from the program that was formerly at the end of the task.

Equation for Estimating Crossload Times

Use this equation to estimate the crossload time of your controllers for each program after you have either of the following:

- The size of the last data transfer
- The maximum size of data that is transferred

ControlLogix 5560 Controllers

$$\text{Crossload time per sync point (ms)} = (\text{DINTs} * 0.00091) + 0.6 \text{ ms}$$

ControlLogix 5570 Controllers

The following equations apply when a ControlLogix 5570 controller is paired with a redundancy module in both chassis in a redundancy system.

Table 12 - Crossload Times for ControlLogix 5570 Controllers

Controller	Paired with Redundancy Module	Crossload Time
ControlLogix 5570	1756-RM2/A	Crossload time per sync point (ms) = (DINTs * 0.000275) + 0.54 ms
	1756-RM/B	Crossload time per sync point (ms) = (DINTs * 0.00043) + 0.3 ms
	1756-RM/A	Crossload time per sync point (ms) = (DINTs * 0.00091) + 0.6 ms Where DINTs is the size of the data transferred measured in 4-byte words.

TIP A sync point is a mechanism that the primary controller uses to keep the secondary controller in sync. By default, at the end of each program scan, the primary controller sends the secondary controller the sync point and the secondary controller responds by moving its execution pointer to match the primary controller.

The default for phases is not to send a sync point.

In revision 16.05x and later, the option exists to manipulate the sync points for faster program execution.

Program to Minimize Scan Times

There are several aspects of your program that must be as efficient as possible to facilitate the fastest possible switchover because total program scan time impacts system switchover time. The sections that follow describe methods to make your program more efficient to minimize your program scan time.

These methods make your program more efficient and minimize program scan times:

- [Use a ControlLogix 5570 Controller with a 1756-RM2/A Redundancy Module](#)
- [Use Multiple Controllers](#)
- [Minimize the Number of Programs](#)
- [Manage Tags for Efficient Crossloads](#)
- [Use Concise Programming](#)

Use a ControlLogix 5570 Controller with a 1756-RM2/A Redundancy Module

In redundancy system revision 19.053 and later, you can use ControlLogix 5570 controllers in your application. Relative to the redundancy module being used, the ControlLogix 5570 controllers scan the controller program faster than ControlLogix 5560 controllers. The ControlLogix 5570 controllers also scan the controller program fastest if the redundancy system uses the 1756-RM2/A redundancy module.

IMPORTANT Only the 1756-L72, 1756-L73, 1756-L74, and 1756-L75 controllers can be used with the 1756-RM2/A redundancy modules and revision 19.053.

If your application needs better controller performance, we recommend that you update from ControlLogix 5560 controllers to ControlLogix 5570 controllers and use 1756-RM2/A redundancy modules.

Use Multiple Controllers

When possible, use multiple controllers in your redundant system. If you use multiple controllers, you can strategically program between the controllers so the program execution and scan times are faster.

Minimize the Number of Programs

When programming a redundant controller, use the fewest programs possible. Use of the fewest programs possible is especially important if you plan to crossload data and synchronize the controllers after the execution of each program.

If you must crossload data at the end of each program, make these programming considerations to minimize the crossload impact on the program scan time:

- Use only one or a few programs.
- Divide each program into the number of routines that is appropriate for your application. A routine does not cause a crossload or increase the scan time.
- Use the main routine of each program to call the other routines of the program.
- If you want to use multiple tasks for different scan periods, use only one program in each task.

Figure 31 - Use of Multiple Routines (preferred)

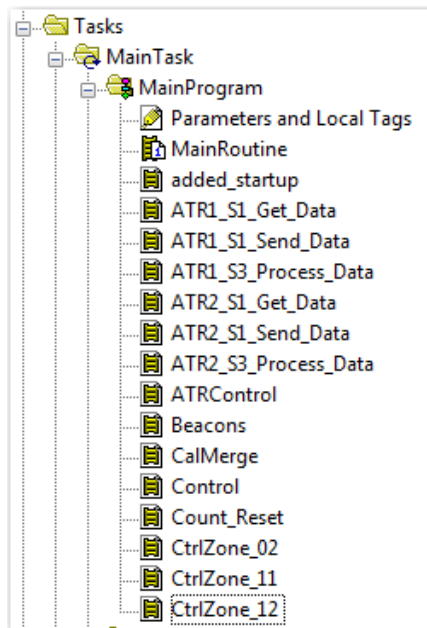
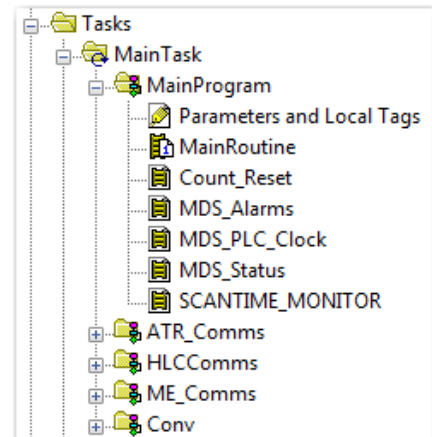

Figure 31 - Use of Multiple Programs (not preferred)



Manage Tags for Efficient Crossloads

Manage your data tags as the following sections recommend to program for more efficient crossloads of data and reduce the amount of time that is required for a crossload to execute.

Delete Unused Tags

If you delete unused tags, it reduces the size of the tag database. A smaller database takes less time to crossload.

Use Arrays and User-Defined Data Types

If you use arrays and User-Defined Data Types, the tags use smaller 4-byte (32-bit) words for all data in the type or array. If you create an individual tag, the controller reserves 4 bytes (32 bits) of memory even if the tag uses only 1 bit.

Arrays and User-Defined Data Types help conserve the most memory with BOOL tags. However, we also recommend that you use them for your SINT, INT, DINT, REAL, COUNTER, and TIMER tags.

Figure 32 - Example Savings with the Use of an Array

12 bytes of data to crossload (4 bytes for each tag).

Name	Data Type	Style
Bool_Tag_1	BOOL	Decimal
Bool_Tag_2	BOOL	Decimal
Bool_Tag_3	BOOL	Decimal

4 bytes of data to crossload.

Name	Data Type	Style
Bool_array1	BOOL[32]	Decimal

TIP If you have already created individual tags and programming that uses those tags, consider changing the individual tags to alias tags that reference the elements in an array.

If you choose this method, your programming can still reference the individual tag names, but the crossload transfers the base array.

For more information about how to work with arrays, User-Defined Data Types, and alias tags, see the Logix 5000 Controllers I/O and Tag Data Programming Manual, publication [1756-PM004](#).

Group Data Types Together in User-Defined Data Types

When you create a User-Defined Data Type for use in your redundancy program, group like data types together. Grouping like data types compresses the data size and helps reduce the amount of data that is transferred during a crossload.

Figure 33 - Example of Bytes Saved by Grouping Like Data

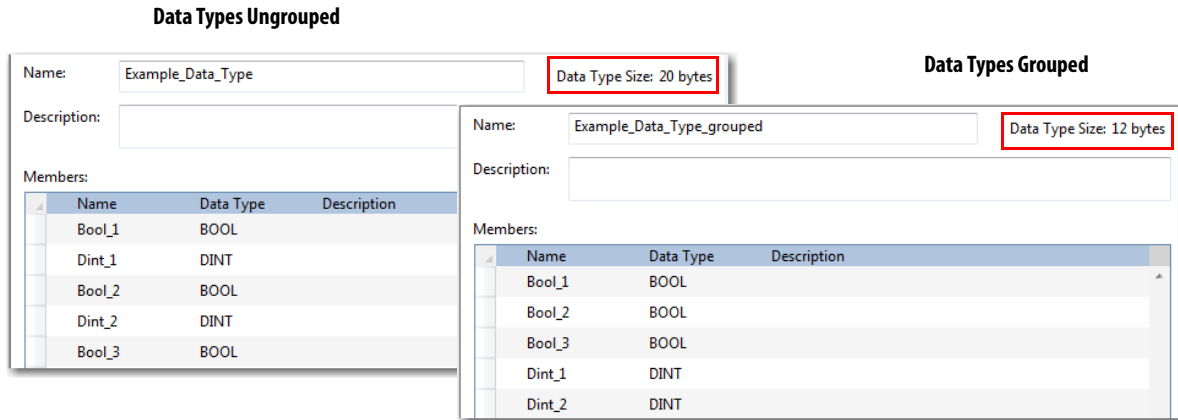

Group Data into Arrays of User-Defined Data Types by Frequency of Use

To update the secondary controller, the primary controller divides its memory into blocks of 256 bytes. Anytime an instruction writes a value, the primary controller crossloads the entire block that contains the value. For example, if your logic writes only 1 BOOL value to a block, the controller crossloads the entire block (256 bytes).

To minimize crossload time, group your data by how frequently your program uses it.

For example, if your application uses DINTs that you use only as constants to initialize your logic, BOOLs that you update every scan, and REALs that you update every second, you can create a separate User-Defined Data Type for each type of tag that is used at different points in the application. Using separate User-Defined Data Types for each group, rather than grouping all tags together in one User-Defined Data Type, helps to minimize the amount of data that is transferred during the crossload.

Tags Grouped into User-Defined Data Types by Frequency of Use

Name	Data Type
[-] My_Bools	My_Bools_UDT
My_Bools.Bool_1	BOOL
My_Bools.Bool_2	BOOL
My_Bools.Bool_3	BOOL
[-] My_Constants	My_Constants_UDT
+ My_Constants.Constant_1	DINT
+ My_Constants.Constant_2	DINT
+ My_Constants.Constant_3	DINT
[-] My_Reals	My_Reals_UDT
My_Reals.Real_1	REAL
My_Reals.Real_2	REAL
My_Reals.Real_3	REAL

Tags in One User-Defined Data Type

Name	Data Type
[-] My_Data	My_Data_UDT
+ My_Data.Constant_1	DINT
+ My_Data.Constant_2	DINT
+ My_Data.Constant_3	DINT
My_Data.Bool_1	BOOL
My_Data.Bool_2	BOOL
My_Data.Bool_3	BOOL
My_Data.Real_1	REAL
My_Data.Real_2	REAL
My_Data.Real_3	REAL

Use DINT Tags Instead of SINT or INT Tags when Possible

We recommend that you use the DINT data type instead of the SINT or INT data types because the controller usually works with 32-bit values (DINTs or REALs). When processing, the controller converts SINT or INT tag values to DINT or REAL values. When processing is complete, the controller converts the value back to a SINT or INT value.

The controller automatically converts these data types while executing and processing a program. No additional programming is required. However, while this conversion process is transparent to you, it does require additional processing time that impacts your program scan time and your switchover time.

Use Concise Programming

Use these recommendations to create concise programming. Using concise programming makes your program execute faster and reduces your program scan time.

Execute an Instruction Only when Needed

We recommend that you execute instructions only when needed because each time an instruction writes a value to a tag, the tag is crossloaded to the secondary controller. Even if the tag values is the same, it is rewritten and is therefore crossloaded.

Because many instructions write tag values whenever executed, strategic and economical use of instructions is needed. Strategic programming techniques include the following:

- Using preconditions to limit the execution of instructions
- Combining preconditions when possible
- Dividing programming into subroutines that are called only when required
- Running noncritical code every 2 or 3 scans instead of during every scan

For example, precondition an ADD instruction to run only when the controller gets new data. As a result, the Dest_Tag is crossloaded only when the ADD instruction produces a new value.

Figure 34 - Precondition Used with ADD Instruction

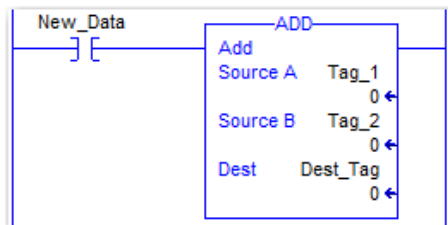

In combination with using preconditions, try to group instructions together that the same instructions precondition. In this example, the four preconditions that are used in the two branches can be combined to precede the two branches. Doing so reduces the number of precondition instructions from four to two.

Figure 35 - Efficient Precondition Use

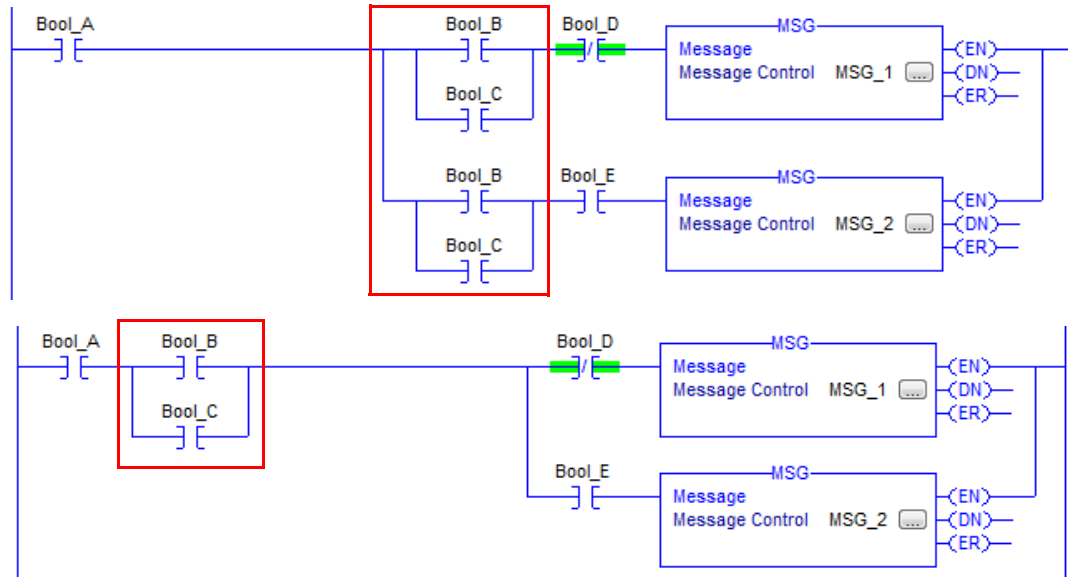

Program to Maintain Data Integrity

When programming your redundant controllers, there are some instructions and techniques that can cause data loss or corruption when used. These instructions and techniques include the following:

- [Array \(File\)/Shift Instructions](#)
- [Scan-dependent Logic](#)

Array (File)/Shift Instructions

Interruptions to Array (File)/Shift Instructions by a higher priority task and then switchover can result in an incomplete data shift and corrupted data.

The following Array (File)/Shift instructions can result in corrupt data in the event of a switchover:

- Bit Shift Left (BSL)
- Bit Shift Right (BSR)
- FIFO Unload (FFU)

If Array (File)/Shift Instructions are used, these system behaviors can result:

1. If a higher priority task interrupts one of the Array (File)/Shift instructions, the partially shifted array values are crossloaded to the secondary controller.
2. If a switchover occurs before the instruction completes its execution, data remains only partially shifted.
3. After a switchover, the secondary controller starts its executing at the beginning of the program. When it reaches the partially executed instruction, it shifts the data again.

Buffering Critical Data

If you cannot place Array (File)/Shift instructions in the highest-priority task, consider using a buffer with Copy File (COP) and Synchronous Copy File (CPS) instructions to maintain the integrity of the array of data.

The programming example that is shown here shows the use of a COP instruction to move data into a buffer array. The BSL instruction uses the data in that buffer array. The CPS instruction updates the array tag and maintains data integrity because a higher priority task cannot interrupt it. If a switchover occurs, the source data (that is, the array tag) remains unaffected.

Figure 36 - Using a Buffer to Maintain Data During Shift

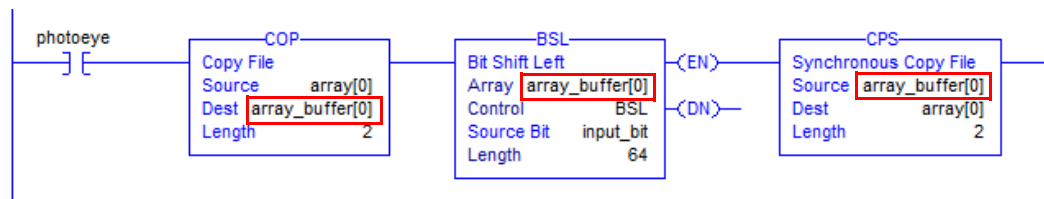

For more information about BSL, BSR, FFU, COP, and CPS instructions see the Logix 5000 Controllers General Instructions Reference Manual, publication [1756-RM003](#).

Scan-dependent Logic

If you program a lower priority task so that one instruction is dependent on another instruction that occurs elsewhere in your program, a task interrupt and switchover can disrupt your programming. The disruption can occur because the higher priority task can interrupt the lower priority task and then a switchover can occur before the lower priority task is completed.

When the lower priority task is executed from the beginning by the new primary controller after the switchover, the dependent instruction can fail to execute at the most recent value or state.

For example, if a higher priority task interrupts the logic that is shown in this example, the value of scan_count.ACC is sent to the secondary controller at the end of the program in the higher priority task. If a switchover occurs before the primary controller completes the EQU instruction, the new primary controller starts its execution at the beginning of the program and the EQU instruction misses the last value of scan_count.ACC. As a result, any programming that uses the Scan_Count_Light tag can also execute by using incorrect data.

Table 13 - Scan-dependent Logic

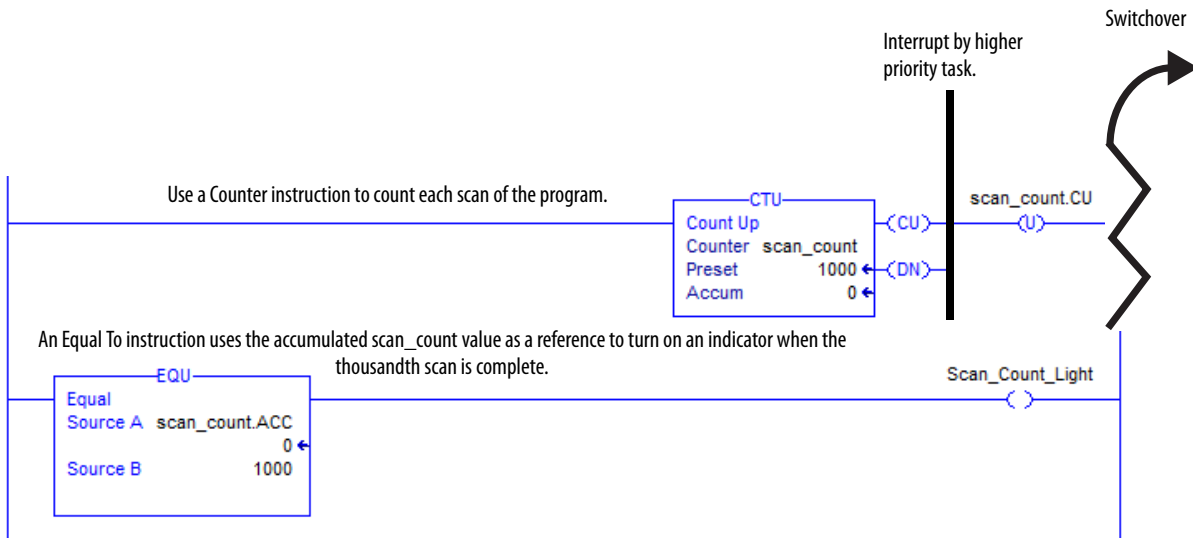

Bind Dependent Instructions with UID and UIE Instructions

If you cannot place scan-dependent instructions in the highest priority task, consider using the User Interrupt Disable (UID) and User Interrupt Enable (UIE) to prevent a higher priority task from interrupting the scan-dependent logic.

For example, if you bind the scan-dependent logic that is previously shown, a higher priority task would not interrupt the dependent instructions and a switchover would not result in inconsistent data.

Figure 37 - Scan-dependent Instructions Bound with UID and UIE Instructions

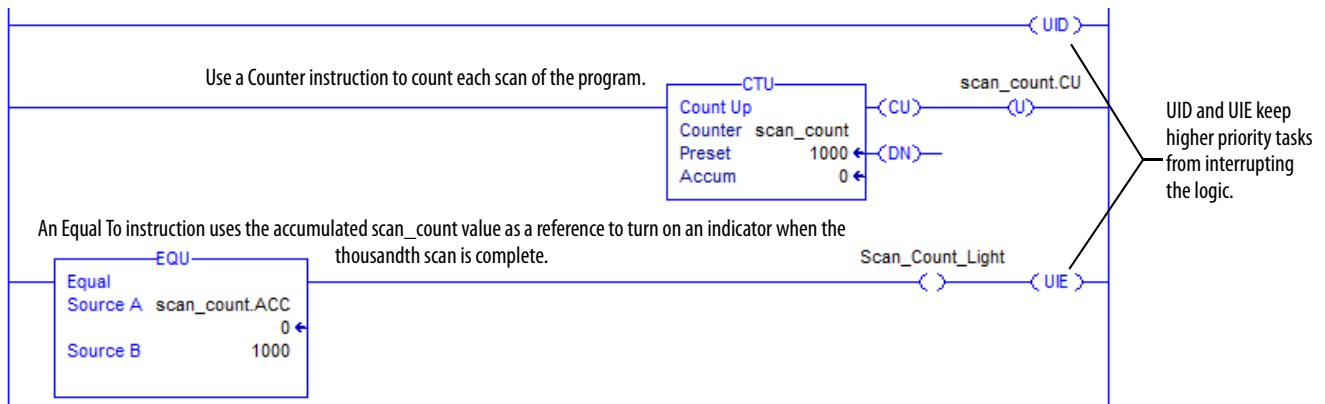

For more information about UID and UIE instructions, see the Logix 5000 Controllers General Instructions Reference Manual, publication [1756-RM003](#).

Program to Optimize Task Execution

To make synchronization, crossloads, and HMI updates as fast as possible, adjust the System Overhead Time Slice and the type of tasks used. These adjustments affect service communication tasks that take place during the time when the continuous task is not executing.

[Table 14](#) lists some of the communication that takes place during a continuous task and service communication periods.

Table 14 - Communication Tasks during Scheduled and Unscheduled Periods

During	These types of communication occur
Task execution	Update I/O data (not including block-transfers)
	Produced/consumed tags
Service communication	Communication with programming devices (for example, Studio 5000 Logix Designer)
	Communication with HMI devices
	Execution of Message (MSG) instructions, including block-transfers
	Responses to messages from other controllers
	Synchronization of the redundant system
	Reestablishment and monitoring of I/O connections, such as Removal and Insertion Under Power conditions. This process excludes normal I/O updates that occur during the execution of logic
	Bridging of communication from the serial port of the controller to other ControlLogix devices via the ControlLogix backplane

To increase service communication to allow for synchronization and the updating of HMI, consider using the techniques that are described in [Table 15](#).

Table 15 - Methods to Increase Service Communication Periods

If your project contains	Then see	On Page
Only a continuous task with no other tasks (This setting is the default task configuration.)	Specify a Larger System Overhead Time Slice	132
Multiple tasks (for example, at least two periodic tasks)	Use Periodic Tasks	135

Specify a Larger System Overhead Time Slice

The system overhead time slice specifies the percentage of time the controller devotes to servicing communication, excluding the time for periodic tasks. The controller interrupts the continuous task to service communication, and then resumes the continuous task.

[Table 16](#) shows the ratio between executing the continuous task and servicing communication at various overhead time slices. Consider the following:

- When the system overhead time slice setting is between 10% and up to 50%, the time that is allocated for servicing communication is fixed at 1 ms. The continuous task time slice changes to produce the desired ratio.
- When the system overhead time slice is greater than 50...90%, the time that is allocated to the continuous task is fixed at 1 ms. The time that is allocated to servicing communication changes to produce the desired ratio.

Table 16 - Overhead Time Slice

At this time slice	The continuous tasks runs for	And service communication occurs for as long as
10%	9 ms	1 ms
20%	4 ms	1 ms
25%	3 ms	1 ms
33%	2 ms	1 ms
50%	1 ms	1 ms
66%	1 ms	2 ms
75%	1 ms	3 ms
80%	1 ms	4 ms
90%	1 ms	9 ms

System Overhead Time Slice Examples

This diagram illustrates a system where the System Overhead Time Slice is set to 20% (default). With this percentage, communication is serviced after every 4 ms of continuous task execution. Communication is serviced for up to 1 ms before the continuous task is restarted.

Figure 38 - System Overhead Time Slice Set to 20%

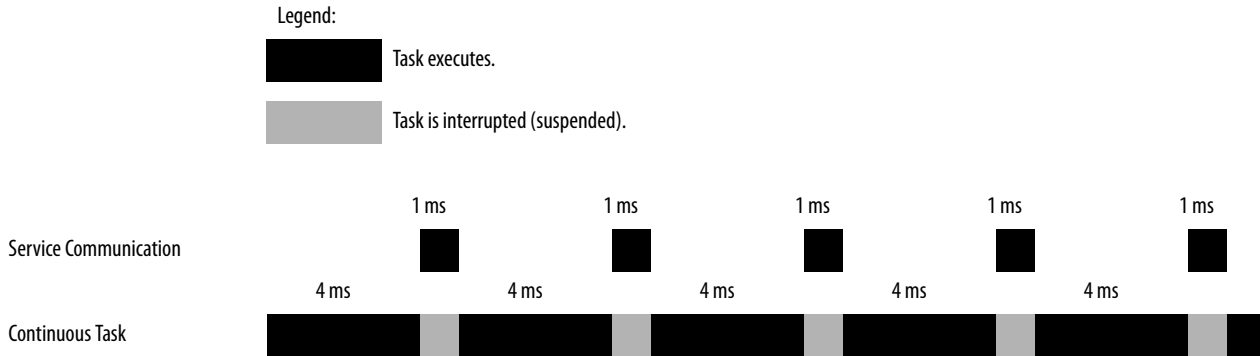

This diagram illustrates a system where the System Overhead Time Slice is set to 33%. With this percentage, communication is serviced after every 2 ms of continuous task execution. Communication is serviced for up to 1 ms before the continuous task is restarted.

Figure 39 - System Overhead Time Slice Set to 33%

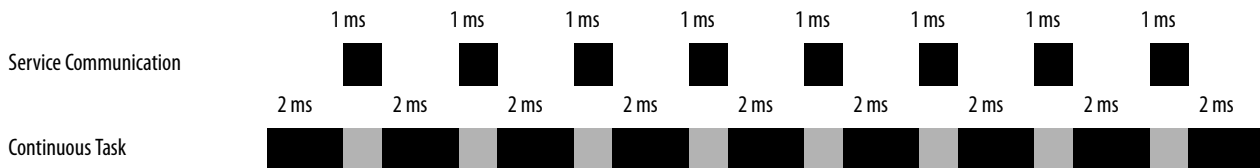

Change the System Overhead Time Slice

To change the System Overhead Time Slice, access the Controller Properties dialog box and click the Advanced tab. You can enter your System Overhead Time Slice value.

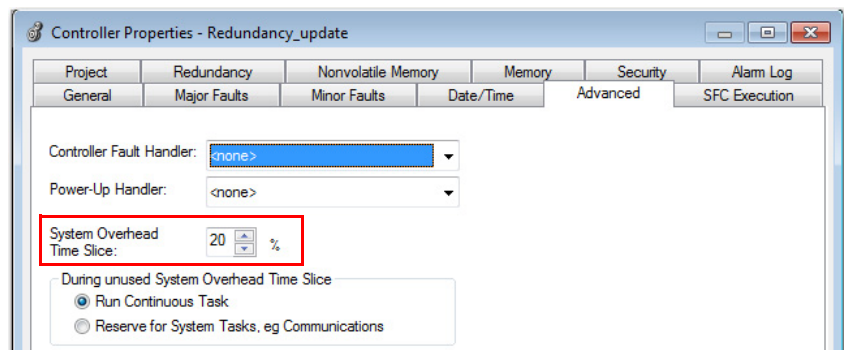

Options for During the Unused System Overhead Time Slice

Enable the **Run Continuous Task** option (default setting) if you want the controller to revert to running the continuous task as soon as the communication servicing task has no pending activity. This setting results in only using the allocated communication servicing time if there is a need for it.

When the Run Continuous Task option selected, the controller immediately returns to the continuous task.

IMPORTANT We do not recommend that you use the Reserve for System Task option for production. The option was developed to simulate systems with high communication requirements.

Use the **Reserve for System Task** option to allocate the entire 1 ms of the System Overhead Time Slice for service communication - even if no service communication or background tasks must be executed. You can choose to use this option without service communication or background tasks to simulate a communication load on the controller during design and programming. Use this setting for testing only.

Use Periodic Tasks

If you have multiple tasks in your project, changing the System Overhead Time Slice does not affect how communication is serviced. To increase the time to service communication when multiple tasks are used, configure the periodic tasks such that more time can be available to service communication.

TIP While you can use multiple periodic tasks in your redundant controller program, use the fewest number of tasks possible.

If you use periodic tasks, communication is serviced any time that a task is not running. For example, if you configure your task period at 80 ms and the task executes in 50 ms, the controller has 30 ms out of every 80 ms to service communication.

Figure 40 - Periodic Task Execution and Service Communication

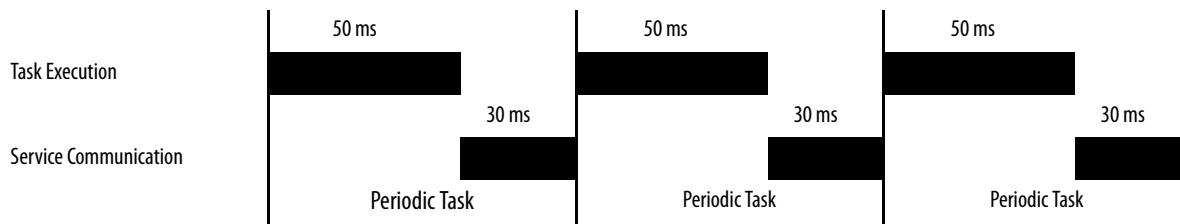

If you use multiple periodic tasks, verify the following:

- The execution time of a highest priority task is smaller than its period.
- The total execution time of all your tasks is less than the period of the lowest priority tasks.

Verifying those settings generally leaves enough time for service communication. The example configuration of tasks that are shown here demonstrates those configuration settings.

Example of Periodic Task Configurations

Task	Priority	Execution Time	Period Specified
1	Higher	20 ms	80 ms
2	Lower	30 ms	100 ms
Total execution time:		50 ms	

In this example, the execution time of the highest priority task (Task 1) is smaller than its period. 20 ms is less than 80 ms. The total execution time of all tasks is less than the specified period of the lowest priority task. 50 ms is less than 180 ms.

Tuning the Period Specified

You can need to tune the period you specify for your periodic tasks to balance program execution and service communication.

TIP The crossloading of data during synchronization points extends task scan times in redundancy systems. We recommend that you balance program execution and service communication when the system is synchronized.

To check for overlaps, go online with the controller and access the Task Properties dialog box. In the Monitor tab, note the maximum scan time. Verify that the maximum scan time is smaller than the period you specified for the periodic task.

Conduct a Test Switchover

Complete these steps to verify that your redundant system switches over as expected. Your system must be fully qualified before you begin.

1. In RSLinx® Classic software, access the RMCT for the **primary** redundancy module.

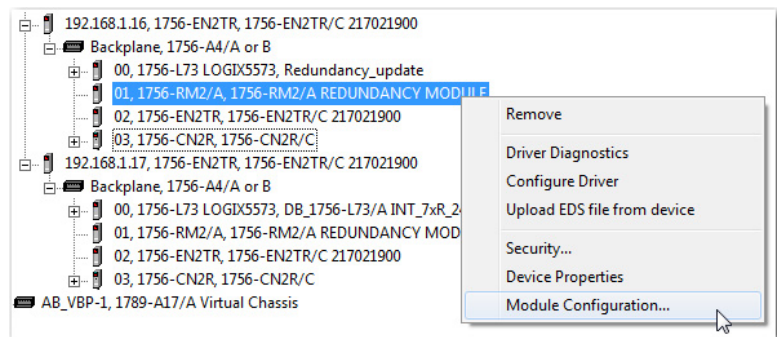

2. Click the Synchronization tab.

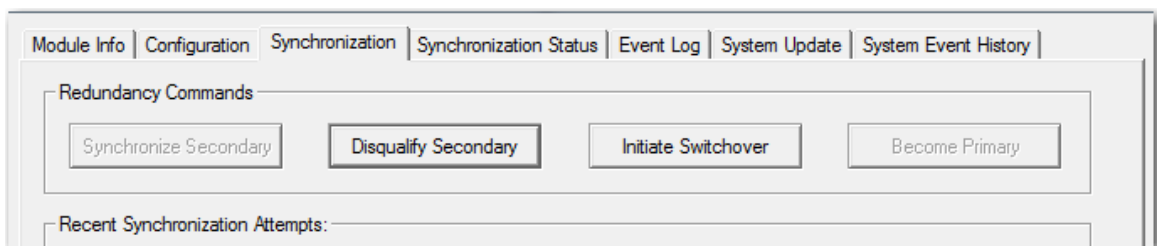

3. Click Initiate Switchover.

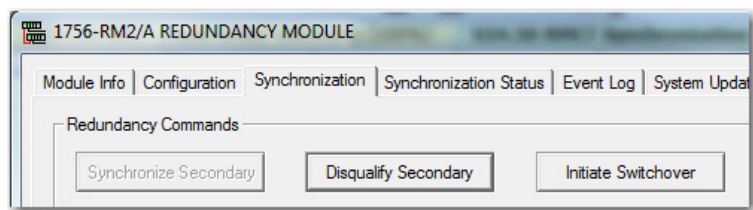

The Redundancy Configuration Tool dialog box opens.

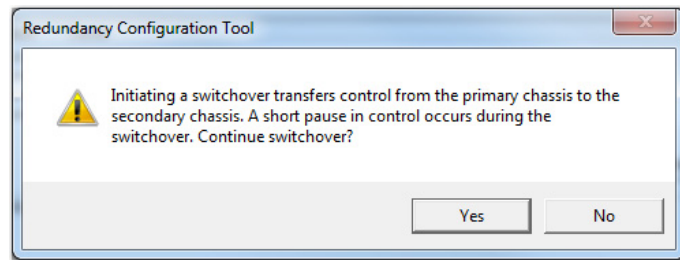

4. Click Yes.

The switchover begins.

5. To verify that the switchover was successful, monitor the RM2 status indicators or the RMCT. You can also view your HMI or other status-monitoring device.

Synchronization After a Switchover

TIP If your Auto-Synchronization parameter is set to Always, your system begins synchronizing immediately after the switchover.

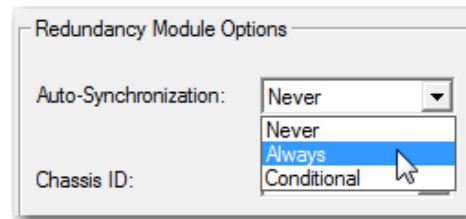

To monitor the synchronization of your system after you initiate the test switchover, you can monitor the synchronization process by using these methods:

- Click the Synchronization Status tab and monitor the Secondary Readiness column. The states No Partner, Disqualified, Synchronizing, and Synchronized indicate the stages of synchronization.
- View the module status display of a **primary** communication module. The states PwNS, PsDS, PwQg, and PwQS indicate the stages of synchronization.
- View the module status display of the **secondary** redundancy module. The states DISQ, QFNG, and SYNC indicate the stages of synchronization.
- Run a second test switchover where you power off the primary chassis to initiate the switchover.

Program Logic to Run After a Switchover

If your application requires certain logic or instructions to be executed after a switchover, then use programming and tags similar to the values shown in this example.

Figure 41 - Precondition Used to Run Logic After Switchover - Ladder Logic

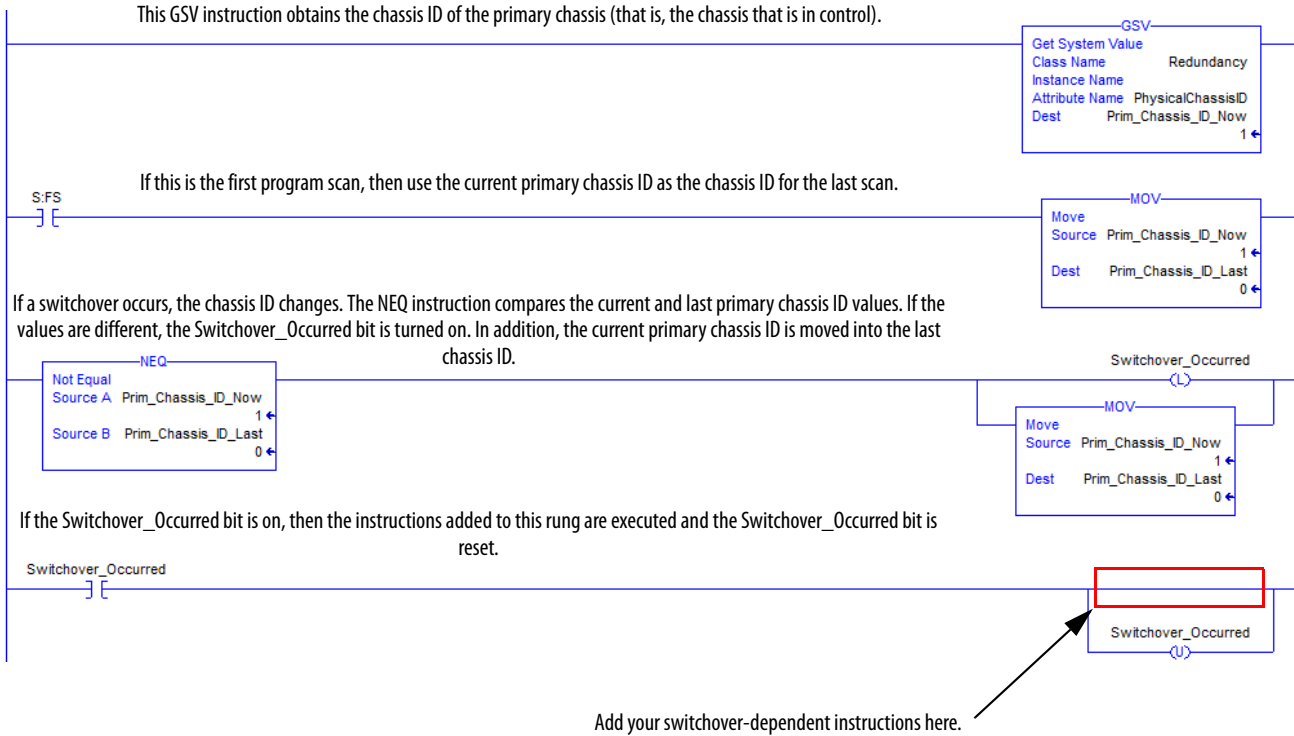

Use Messages for Redundancy Commands

For some applications, consider programming the controller to issue redundancy system commands via the redundancy modules. The sections that follow explain how to configure a MSG instruction to issue a redundancy command.

Verify User Program Control

For a MSG instruction to issue a command via the redundancy modules, the redundancy modules must be configured for user program control.

To verify that the modules are enabled for user program control, access the Configuration tab of the RMCT and verify that Enable User Program Control is checked.

Figure 42 - Enable User Program Control in the RMCT

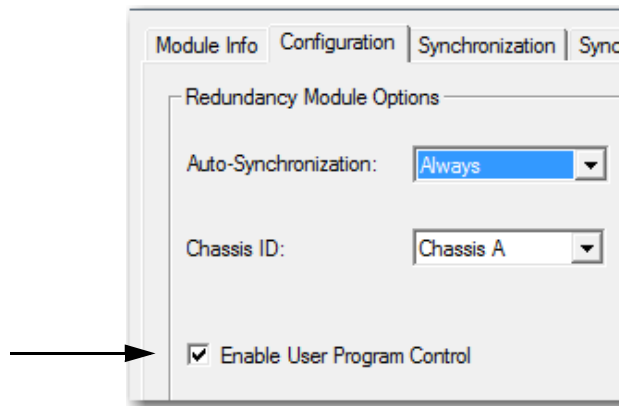

Use an Unconnected Message

When you add your MSG instruction for issuing the command through the redundancy modules, configure it as an unconnected message.

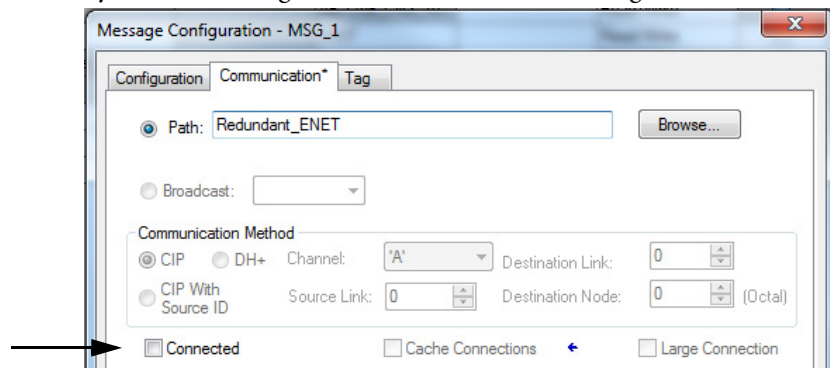

Configure the MSG Instruction

Use the MSG configuration settings that correspond to the command you intend to issue to the redundancy modules.

If you must	See page
Initiate a Switchover	140
Disqualify the Secondary Chassis	142
Synchronize the Secondary Chassis	142
Set the Redundancy Module Date and Time	143

Initiate a Switchover

To initiate a switchover, use the MSG instruction parameters that are listed in [Table 17](#).

Table 17 - MSG Instruction to Initiate a Switchover

In this tab	Edit this element	To use this value
Configuration	Message Type	CIP™ Generic
	Service Type	Custom
	Service Code	4e
	Class	bf
	Instance	1
	Attribute	None - no value needed
	Source Element	INT tag with a value of 1
	Source Length	2
	Destination Element	None - no value needed.
Communication	Path	1 - the slot number of the 1756-RM, 1756-RM2, 1756-RMXT, or 1756-RM2XT module.
	Connected box	Leave the Connected checkbox unchecked.

Use [Table 18](#) to when using MSG instructions during a switchover.

Table 18 - MSG Instruction Behavior During a Switchover

If the MSG instruction is	Then
From a redundant controller	In a redundant controller, any MSG instruction that is in progress during a switchover experiences an error. (The ER bit of the instruction turns on.) After the switchover, normal communication resumes.
To a redundant controller	For any MSG instruction from a controller in another chassis to a redundant controller, cache the connection: Properties of the Message to the Redundant Controller
Configured Message Instructions	
If the MSG instruction originates from a redundant controller	Then
During a switchover	The message instructions status bits are updated asynchronously to the program scan. Consequently, you cannot crossload your message instructions status bits to a secondary controller. During a switchover, any active message instructions become inactive. When this change occurs, you must reinitialize the execution of your message instructions in the new primary controller.
During qualification	The scrolling display changes from CMPT for compatible to Qfng for qualifying. <ul style="list-style-type: none"> • If a configured message is cached, the primary controller automatically establishes a connection with no errors. • If a configured message is uncached or unconnected, the primary controller receives Error 1 Extended Error 301, No Buffer Memory.
If the message is targeted to a redundant controller	Then
During the erroring out of a message	All backplane communication ceases. This stoppage lets the redundant controller receive the message instruction that is required to perform a switchover or any diagnostics. Important: If any of your messages are active during a switchover, you can expect one of these things to happen: <ul style="list-style-type: none"> • Cached and connected messages cause the message instruction to pause for 7.5 seconds because the initiating controller has not received a response from the targeted controller. For cached messages, the message instruction tries to execute three more times, each attempt followed by a pause of 7.5 seconds. If, after 30 seconds pass, the targeted controller does not respond to the initiating controller, then the switchover errors out with connected time-out Error 1 Extended Error 203. An example of a connected message would be CIP data table read-and-write messages after a connection has been established. • Uncached messages error out after 30 seconds if you have initiated them because the initiating controller never received a reply to the forward-open request. The error is Error 1F Extended Error 204, an unconnected time-out. Examples of uncached messages would include CIP generic messages and messages that are captured during the connection process.
During qualification	Cached messages that run with no errors. A connection has been established. Connected, but uncached, messages or unconnected messages error out with Error 1 Extended Error 301, No Buffer Memory .

Disqualify the Secondary Chassis

To disqualify the secondary chassis, use the MSG instruction parameters that are listed in [Table 19](#).

Table 19 - Disqualify the Secondary Chassis

In this tab	Edit this element	To use this value
Configuration	Message Type	CIP Generic
	Service Type	Custom
	Service Code	4d
	Class	bf
	Instance	1
	Attribute	None - no value needed
	Source Element	INT tag with a value of 1
	Source Length	2
	Destination Element	None - no value needed.
Communication	Path	1 - the slot number of the 1756-RM, 1756-RM2, 1756-RMXT, or 1756-RM2XT module.
	Connected box	Leave the Connected checkbox unchecked.

Synchronize the Secondary Chassis

To disqualify the secondary controller, use the MSG instruction parameters that are listed in [Table 20](#).

Table 20 - Synchronize the Secondary Chassis

In this tab	Edit this element	To use this value
Configuration	Message Type	CIP Generic
	Service Type	Custom
	Service Code	4c
	Class	bf
	Instance	1
	Attribute	None - no value needed
	Source Element	INT tag with a value of 1
	Source Length	2
	Destination Element	None - no value needed.
Communication	Path	1 - the slot number of the 1756-RM, 1756-RM2, 1756-RMXT, or 1756-RM2XT module.
	Connected box	Leave the Connected checkbox unchecked.

Set the Redundancy Module Date and Time

To set the WallClockTime of the 1756-RM module, use the MSG instruction parameters that are listed in [Table 21](#).

Table 21 - Set WallClockTime

In this tab	Edit this element	To use this value
Configuration	Message Type	CIP Generic
	Service Type	Custom
	Service Code	10
	Class	8b
	Instance	1
	Attribute	b
	Source Element	WallClockTime[0] WallClockTime is a DINT[2] array that stores the CurrentValue of the WallClockTime object
	Source Length	8
	Destination Element	None - no value needed.
Communication	Path	1 - the slot number of the 1756-RM, 1756-RM2, 1756-RMXT, or 1756-RM2XT module.
	Connected box	Leave the Connected checkbox unchecked.

Set the Task Watchdog

Watchdog times set for tasks in redundancy applications must be larger than watchdog times set for tasks in non-redundancy applications because more time is required to conduct crossloads and synchronization.

An increase in the required watchdog time is also a result of the way programs are executed in the event of a switchover. A program or programs can be executed a second time after switchover. This action depends on when in the task or program the switchover occurs and where in the task crossload and synchronization occurs.

If a program is executed a second time, the length of time that is required for the program scan is increased. However, the watchdog timer is not reset and continues to countdown from the beginning of the task that the old primary controller started. Therefore, the watchdog timer must be configured to account for the potential of additional program scans.

We recommend that you reevaluate the watchdog times in your application if either of these events occur:

- A second controller is added to a redundancy chassis.
- The application in a second controller that is already in the system is modified.

Figure 43 - Watchdog Configured for Redundancy Switchover

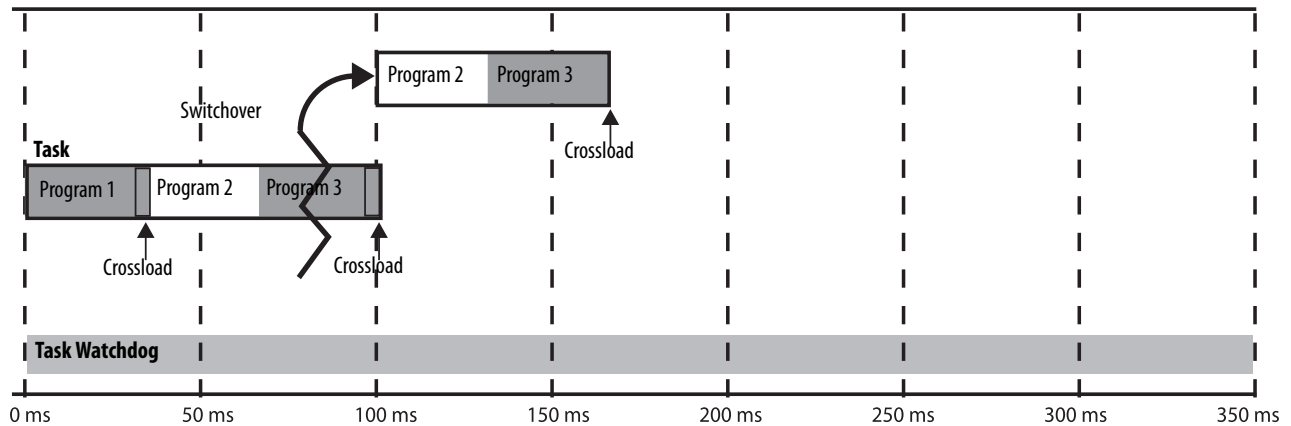

In the event of a watchdog timeout, a major fault (type 6, code 1) results. If this fault occurs after a switchover, the control system fails-to-safe or to the configured hold state.

Figure 44 - Watchdog Not Configured for Redundancy Switchover

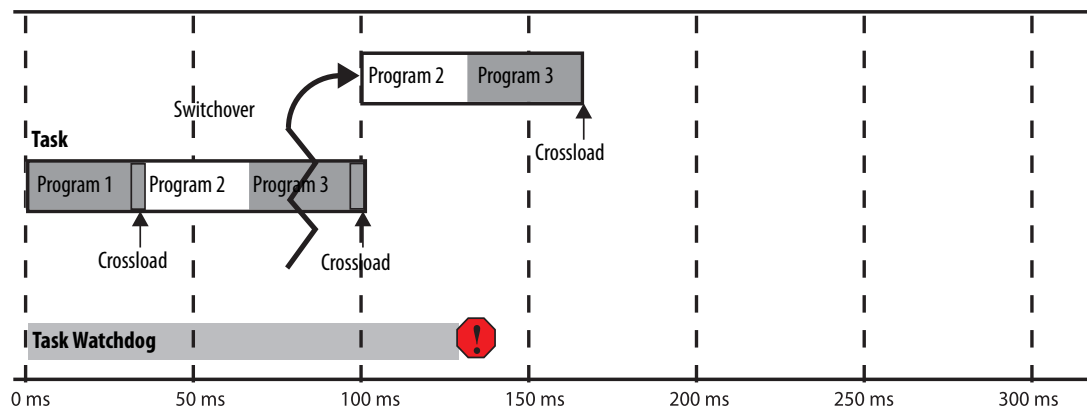

Minimum Value for the Watchdog Time

To set Watchdog time for your ControlLogix 5560 controllers, use this table to determine which equation to use to calculate the time for each task.

If	Then use this equation
Using ControlNet® I/O ms	$(2 * \text{maximum_scan_time}) + 150$
Using Ethernet I/O ms	$(2 * \text{maximum_scan_time}) + 100$

The *maximum_scan_time* is the maximum scan time for the entire task when the secondary controller is synchronized.

To set the initial task tuning of the ControlLogix 5570 controller, follow these steps.

IMPORTANT This process works only when there is no Continuous task that is configured in the Logix application.

1. Monitor the Max Scan Time for each task while the redundant chassis pair is synchronized.
2. Set the Watchdog times for each task to three times the Max Scan Time.
3. To configure each Task Period, use the Logix 5000™ Task Monitor Tool.⁽¹⁾
 - a. Adjust the Task periods of each so that the maximum scan time is less than 80% of the task period rate.
 - b. Adjust the Task periods so that the Logix CPU % utilization is never above 80%.
 - c. While performing these tests, the HMI and any other external systems must be connected to the Logix controller.

IMPORTANT Verify that there are no task overlaps.

Download the Project

Download the project only to the primary controller. When the secondary controller is synchronized, the system automatically crossloads the project to the secondary controller.

IMPORTANT If the secondary chassis was qualified and becomes disqualified after you download the project, verify that you have enabled the controller for redundancy.

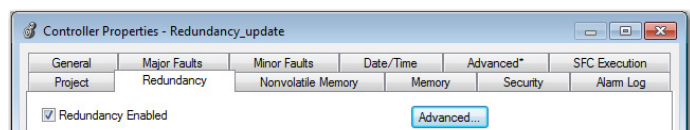

(1) See the PlantPAx® Process Automation System Reference Manual, publication [PROCES-RM001](#).

Store a Redundancy Project to Nonvolatile Memory

Use this procedure to store an updated project and firmware to the nonvolatile memory card of the controller.

This section describes how to store a project to nonvolatile memory in either of these conditions:

- [Store a Project While the Controller is in Program or Remote Program Mode](#)
- [Store a Project While a System is Running](#)

IMPORTANT We recommend that you store the same project on the nonvolatile memory cards of both controllers. By doing so, you can be assured that if a controller, primary or secondary, loses the project from its internal memory, you can load the most recent project back onto that controller.

If you store the same project on the nonvolatile memory cards of both controllers, while the process is running, you must save the project on the controllers while they are in the secondary controller state. To do so, you save the project on the secondary controller, conduct a switchover, and save the project on the new secondary controller. Even if you do not plan to use the SD card, leave the card installed in the controller to collect diagnostic information that you can provide to Rockwell Automation Technical Support.

For more information, see the steps in [Store a Project While the Controller is in Program or Remote Program Mode on page 147](#) or [Store a Project While a System is Running on page 148](#).

Store a Project While the Controller is in Program or Remote Program Mode

If you want to store your controller project in nonvolatile memory while your redundant system is not running, complete these steps. Before you begin, verify that a controller communication path has been specified and that you are able to go online with the primary controller.

1. Verify that the redundant chassis are synchronized. If they are not synchronized, synchronize them.
2. To put the primary controller into Program or Remote Program mode, use programming software or the mode switch.
3. In RSLinx Classic communication software, right-click the 1756-RM module and choose Module Configuration to open the RMCT.

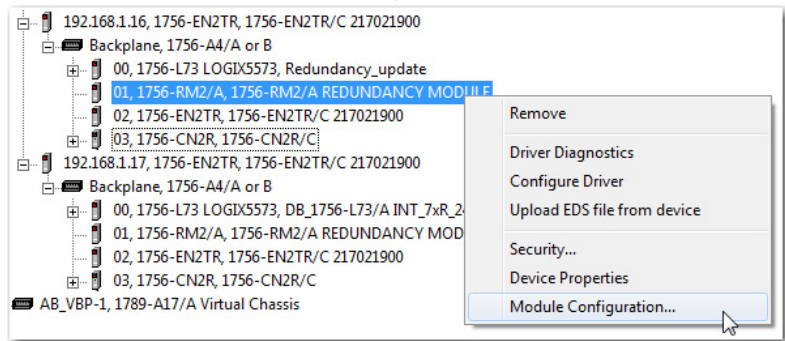

4. In the Configuration tab, set the Auto-Synchronization parameter to Conditional.

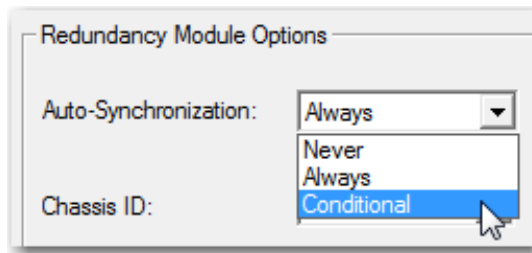

5. On the Synchronization tab, click Disqualify Secondary.

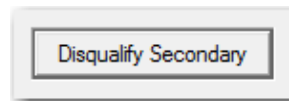

6. In the programming software, access the Controller Properties dialog box and click the Nonvolatile Memory tab.
7. Click Load/Store.
8. Click <-- Store and then click Yes.

When the store is complete, we go online with the secondary controller.

9. Complete [steps 6...8](#) to store the project in nonvolatile memory of the secondary controller.
10. In RSLinx Classic software, open the RMCT for one of the redundancy modules in the redundant pair.
11. In the Synchronization tab, click Synchronize Secondary.

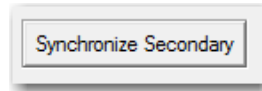

12. In the Configuration tab, set the Auto-Synchronization option to your desired setting.

Store a Project While a System is Running

If you want to store your controller project in nonvolatile memory while your redundant system is running, complete these steps.

1. Verify that the redundant chassis are synchronized.

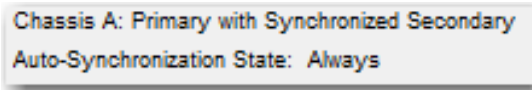

2. In the RMCT, access the Configuration tab and set the Auto-Configuration parameter to Never.
3. In the Synchronization tab, click Disqualify Secondary.
4. Go online with the secondary controller.

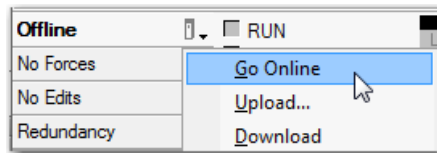

IMPORTANT Do not go online with the primary controller until you have completed this procedure.

5. Open the Controller Properties dialog box and click the Nonvolatile Memory tab.
6. To store the project in nonvolatile memory, click Load/Store then <-- Store.
7. In the RMCT, click the Synchronization tab.
8. Click Synchronize Secondary and wait for the system to synchronize.
9. Click Initiate Switchover.

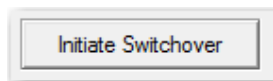

10. Go online with the new secondary controller.
11. Complete [step 5](#) and [step 6](#) to store the project.
12. In the RMCT, click the Configuration tab and set the Auto-Configuration to your desired setting.
13. In the Synchronization tab, click Synchronize Secondary.

You have completed the steps that are required to store your project while online.

Load a Project

If you must load a project from nonvolatile memory, you must first disqualify your redundancy system. You then load the project from the primary controller and resynchronize the redundant chassis once the load is complete.

For details about loading a project from nonvolatile memory, see the Logix 5000 Controllers Nonvolatile Memory Card Programming Manual, publication [1756-PM017](#).

Online Edits

You can edit the redundant controller program while the system is online and running. However, considerations specific to redundancy must be made with considerations described in the Logix 5000 Controllers Quick Start, publication [1756-QS001](#).

Support for Partial Import Online

Beginning with redundancy system revision 19.052 or later, you can use the Partial Import Online (PIO) feature available in the programming software.

Consider these points when using PIO with redundancy systems at revision 19.052 or later:

- If you select **Import Logix Edits as Pending** or **Accept Program Edits** when executing a PIO, the primary controller treats the PIO feature as a set of multiple test edits where, after the import is complete, you can switch between testing the edits or not.
- We recommend that you do not use **Finalize All Edits in Program** when you import edits. If you use this option, any failure due to the import causes a failure on the new primary controller after a switchover.
- If edits exist in the primary controller due to a PIO, they are treated the same as normal test edits regarding the 'Retain Test Edits at Switchover' selection and Redundancy System Update.
- If a PIO is in progress, the primary controller rejects any attempt to qualify.
- If you attempt to initiate a PIO on a primary controller in the process of qualifying the system, that PIO is rejected.

- If a switchover occurs while the PIO is still in process, a PIO to a primary controller can fail.

When the anomaly occurs and the PIO fails, you can see any of these errors:

- Failed to import file 'c\...\xxx.L5x
Object already exists
- Failed to import file 'c\...\xxx.L5x
Already in request mode/state
- CIP error: Problem with a semaphore
- Internal Object Identifier (IOI) destination unknown

After switchover is complete, reattempt the PIO and it completes successfully.

There are additional considerations necessary to performing online edits:

- [Plan for Test Edits](#)
- [Finalize Edits with Caution](#)
- [Reserve Memory for Tags and Logic](#)

Plan for Test Edits

Before you begin editing your redundant program while your system is running, verify that the Retain Test Edits on Switchover setting meets your application requirements.

IMPORTANT We recommend that you leave the Retain Test Edits on Switchover setting at the default (that is, unchecked) to avoid faulting both controllers when testing your edits.

If you enable the system to retain the test edits on a switchover (that is, you check Retain Test Edits on Switchover), faults that result from the test edits can also occur on the new primary controller after a switchover.

If you do not enable the system to retain the test edits on a switchover (that is, you leave Retain Test Edits on Switchover unchecked), faults that result from the test edits are not carried over to the new primary controller in the event of a switchover.

Use this table to determine the Retain Test Edits on Switchover setting that suits your application.

If you must	Then
Prevent a test edit from faulting both the primary and secondary controller	Leave Retain Test Edits on Switchover unchecked
Keep test edits active, even in the event of a switchover and at the risk of faulting both controllers	Check Retain Test Edits on Switchover

To change the Retain Test Edits on Switchover setting, click the Redundancy tab in the Controller Properties then click Advanced.

Figure 45 - Retain Test Edits on Switchover

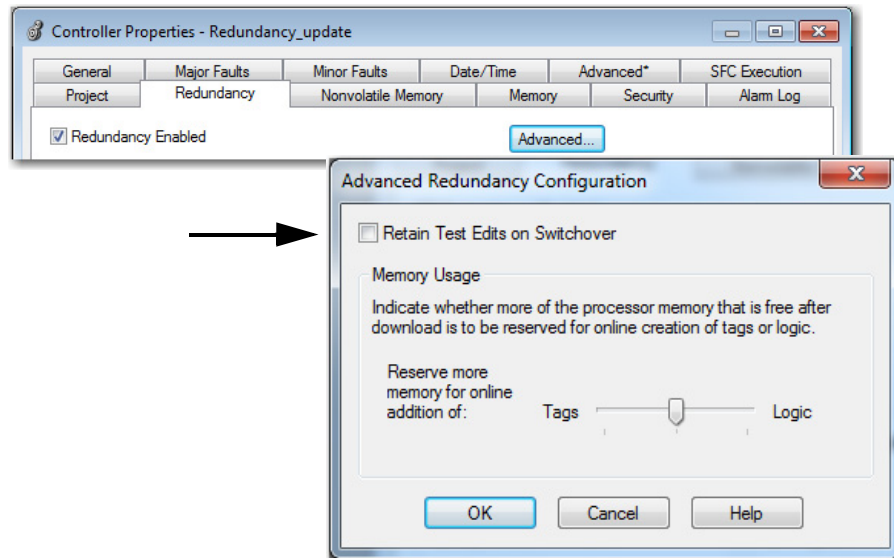

Finalize Edits with Caution

When you finalize edits to your program while online, the original program that existed before the changes were made is deleted. As a result, if the edits you finalize cause a fault on the primary controller, the new primary controller also faults after the switchover. Also, when you finalize edits in the primary controller, the edits are also finalized in the secondary controller.

Before you finalize any edits to your program, test the edits to verify that faults do not occur.

1. In the Controller Organizer, open the routine you must edit.
2. Make the appropriate changes to your routine.
3. Click the Verify Routine button.
4. Click the Accept Pending Program Edits button.

Figure 46 - Test Edits Before Finalizing

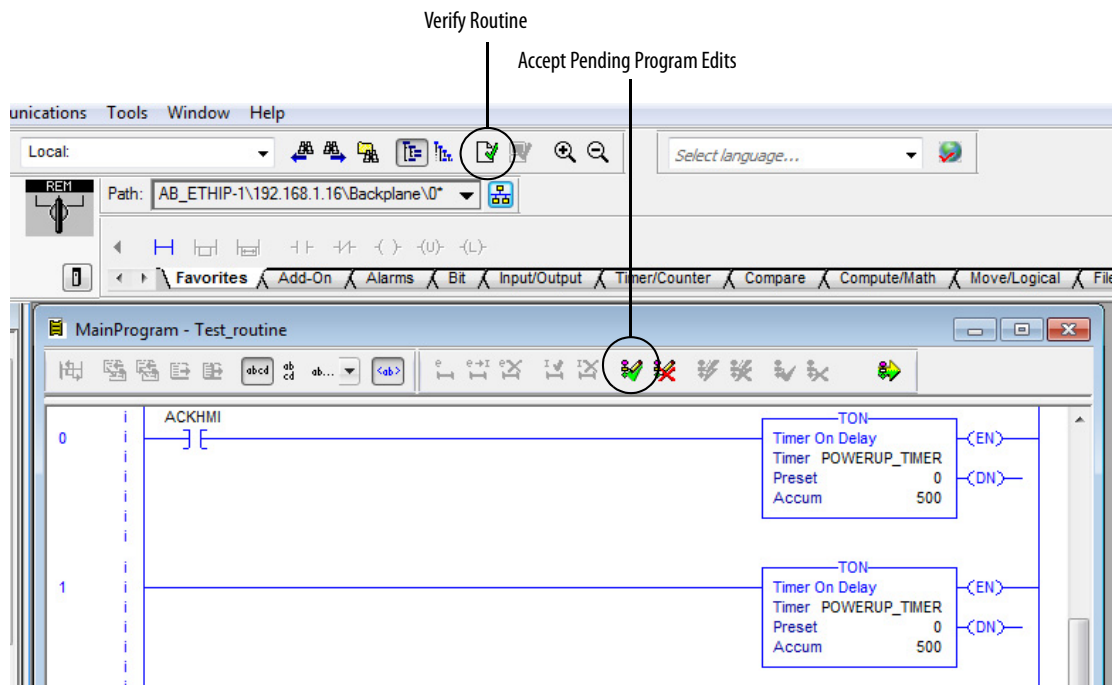

TIP Even if you have not enabled the Retain Test Edits on Switchover property, faults can still occur on the primary and secondary controllers if the edits are finalized.

The Retain Test Edits on Switchover property affects only edits that are being tested. The Retain Test Edits on Switchover does not affect the redundant controllers that are running finalized edits.

5. At the Accept the Pending Edits dialog box, click Yes.

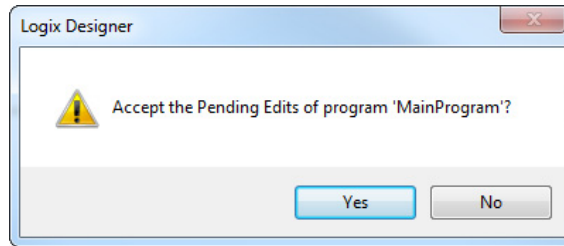

6. Click Test Accepted Program Edits.

Test Accepted Program Edits

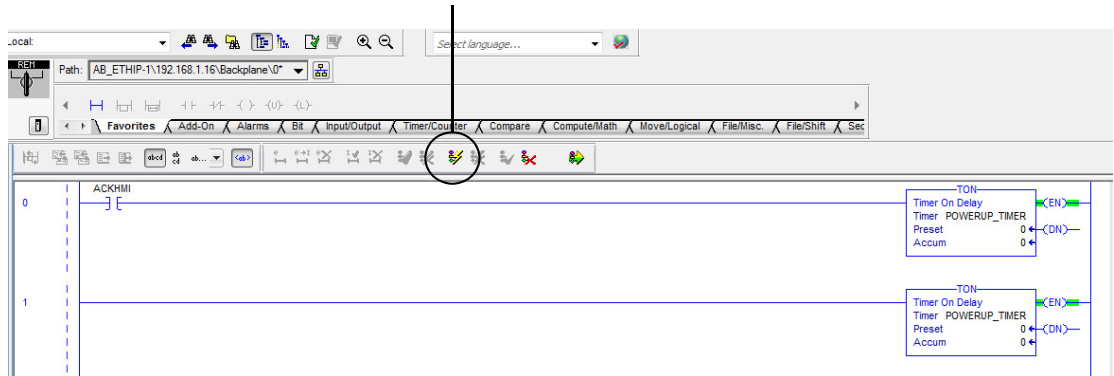

7. At the dialog box, click Yes.

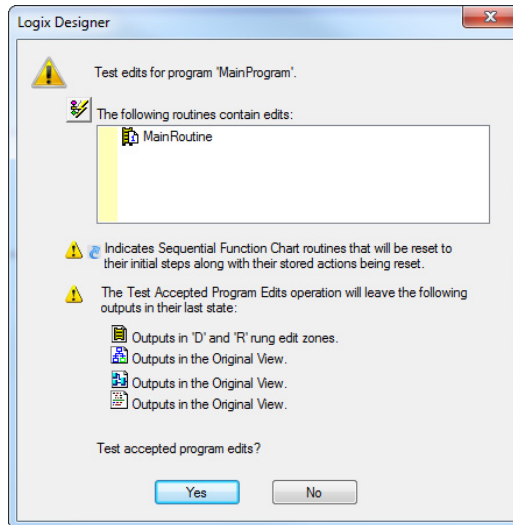

8. Click Finalize All Edits in Program.

Finalize All Edits in Program

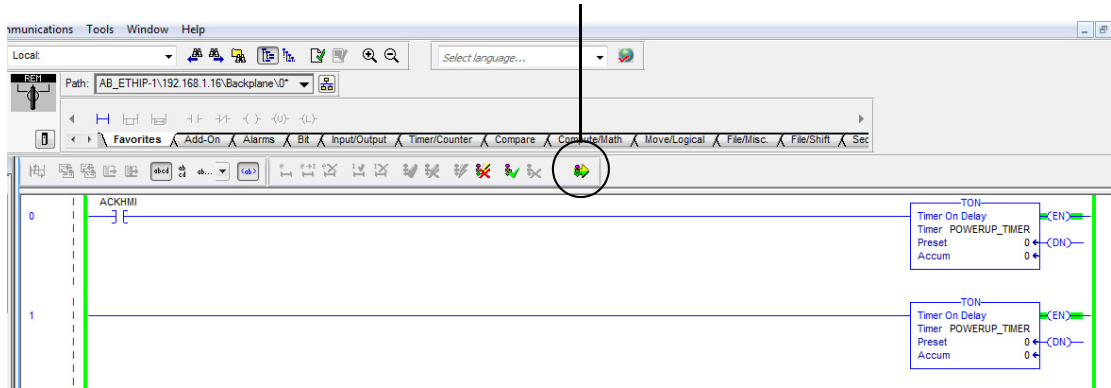

9. At the dialog box, click Yes.

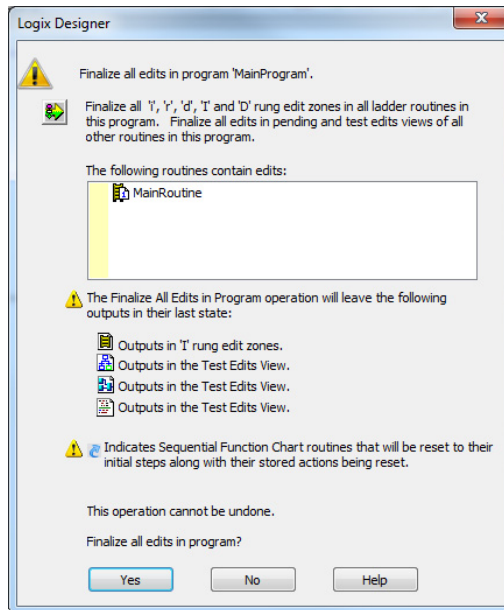

Your edits are now finalized.

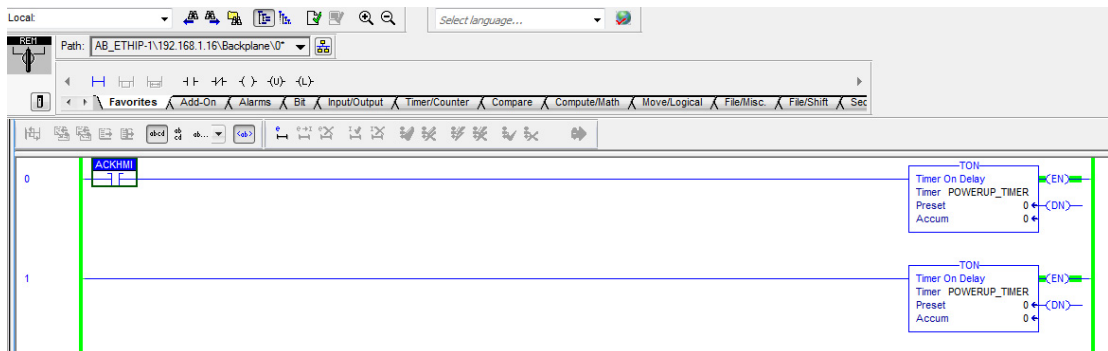

Reserve Memory for Tags and Logic

IMPORTANT Do not change the Memory Usage settings for Tags and Logic unless Rockwell Automation Technical Support instructs you to change the settings.

Depending on your redundant application, you can need to change the memory usage property for your redundant controller. The setting that you specify impacts how the controller divides memory for tags and logic to be stored to the buffer during a crossload to the secondary controller. [Table 22](#) indicates when you can consider changing the memory usage setting

Table 22 - Possible Memory Usage Setting Change

If your online edits are primarily changes to	Then move the Memory Usage slider towards
Tags with little or no changes to logic	Tags
Logic with little or no new tags created	Logic

IMPORTANT Do not set the Memory Usage slider to only Tags or Logic:

- Moving the slider to only Tags can block you from performing edits while online and OPC communication can fail.
- If you move the slider to only Logic, you cannot create or edit any tags while online.

IMPORTANT When using a ControlLogix 5570 redundancy controller using version 19 software, and the Memory Usage slider is set to the far left for Tags, the first synchronization attempt is successful. However, after switchover or disqualification, the next qualification attempt fails, and one or more entries appear in the secondary redundancy module event log with the following description: '(14) Error Setting Up Data Tracking.'

To recover from this issue, move the slider slightly to the right. This change must be made offline or in Program mode. Additionally, you must download the updated application to the disqualified secondary to update its configuration. The next qualification attempt is successful.

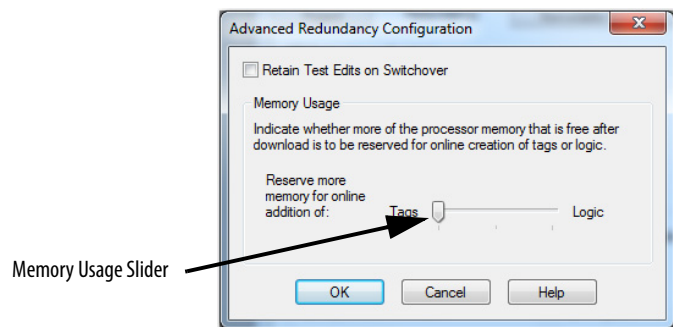

Notes:

Monitor and Maintain a Redundancy System

Topic	Page
Controller Logging	157
Monitor System Status	159
Verify Date and Time Settings	161
Verify System Qualification	162
Check the EtherNet/IP Module Status	164
Check the ControlNet Module Status	166

This chapter describes some of the key tasks to complete to monitor and maintain your redundancy system.

Controller Logging

Beginning with redundancy system revision 19.052, you can use the controller logging feature. This feature provides a way to detect and log changes. These changes include programming software and controller mode switch interactions, made to ControlLogix® 5560 and ControlLogix 5570 controllers, without adding any auditing software.

With controller logging, the controller can perform these tasks:

- Detect changes and create logs entries that contain information about the changes.
- Store the log entries to a Compact FLASH (CF) card or Secure Digital (SD) card for later review.
- Provide programmatic access to log entry counters to provide change detection information remotely.

Controller Log

A controller log is the record of changes. The log is stored on the NVS memory of the controller automatically. You can store the log to a CF card or SD card on an as needed basis or automatically at predefined times. The NVS memory of the controller and each external memory card type has a maximum number of entries that they can store.

Specific events are stored in the log of the controller.

For more information on controller logging, see the Logix 5000 Controllers Information and Status Programming Manual, publication [1756-PM015](#).

Controller Logging in Redundancy Systems

Because redundancy systems operate with partnered controllers, there are considerations that you must consider regarding controller logging:

- The primary and secondary controllers maintain separate logs.
- You do not need to synchronize the logs.
- On the primary controller, controller logging occurs exactly as it does on a controller in a non-redundant system, regardless of whether the system is qualified and synchronized or disqualified.
- A secondary controller logs the removal or insertion of removable storage components, that is, a CF or SD card, in any operating state. Otherwise, the secondary controller only logs events that occur when the controller is in a disqualified state.

Component Change Detection

Component tracking allows you to determine whether tracked routines, Add-On Instructions, and constant tags have been changed. The Studio 5000 Logix Designer® application creates a tracked value to indicate the current state of all components.

For more information, see the Logix 5000 Controllers Information and Status Programming Manual, publication [1756-PM015](#).

Monitor System Status

IMPORTANT When programming your redundancy system, program so your redundancy system status is continually monitored and displayed on your HMI device.

If your redundancy system becomes disqualified or a switchover occurs, the change in status is not automatically annunciated. You must program the system to communicate the change in status via your HMI or other status-monitoring device.

For most redundant applications, you must program to obtain the status of the system. Program to obtain system status when you do the following:

- Program HMI to display the system status
- Precondition logic to execute based on the system status
- Use the diagnostic information to troubleshoot the system

To obtain the status of your redundant system, use a Get System Value (GSV) instruction in your program and plan for the tags you are writing the values to.

In the following example, the GSV instruction is used to obtain the chassis ID (that is, the chassis A or B designation) of the chassis that is functioning as the primary. The **PhysicalChassisID** value is stored in the **PRIM_Chassis_ID_Now** tag. The **PhysicalChassisID** value that is retrieved matches the Chassis ID indicated in the Controller Properties dialog box.

If the Physical Chassis ID Value is	Then the Chassis ID is
0	Unknown
1	Chassis A
2	Chassis B

Figure 47 - GSV Instruction to Get Chassis ID

Ladder Logic

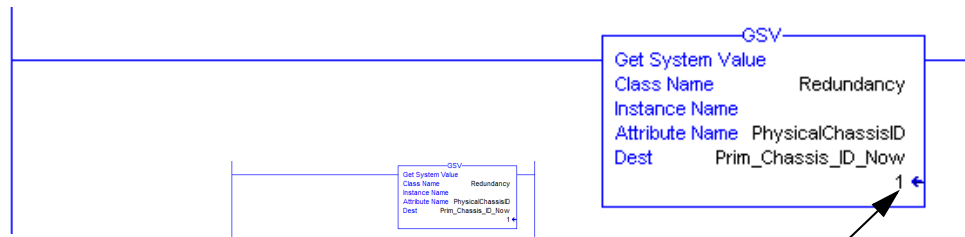

Structured Text

```
GSV (REDUNDANCY, , PhysicalChassisID, PRIM_Chassis_ID_Now);
```

Chassis ID in Controller Properties

Redundancy Status	
Chassis Id:	A
Chassis State:	Primary with Synchronized Secondary
Module State:	Primary with Synchronized Secondary
Module Compatibility:	Fully Compatible Partner

For more information about the REDUNDANCY object attributes, see [Appendix B. Redundancy Object Attributes on page 223.](#)

Verify Date and Time Settings

Verify that the Redundancy Module Date and Time information matches the date and time of your system after you have configured and downloaded your redundant system to the controller.

TIP Consider checking the Redundancy Module Date and Time as a part of your regular maintenance procedures. Regular verification of the date and time information keeps the event logs of the redundancy modules accurate.

If the date and time are not correct, the redundant system event logs do not match the date and time information for the rest of the system. Incorrect date and time information complicates troubleshooting if an event or error occurs on your redundant system.

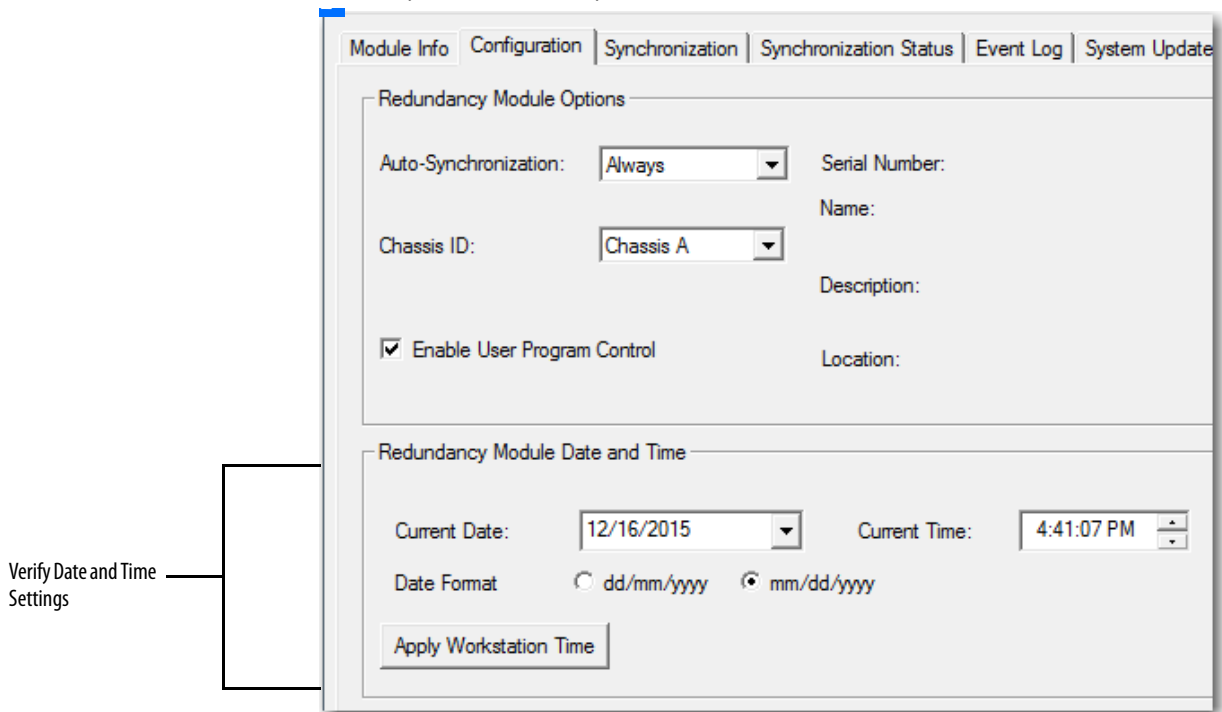

IMPORTANT If power to one of the redundancy modules is cycled, the redundancy module powers up with the time set to when the power was lost. If the partner redundancy module has remained active during this time, the time set in that module is automatically transferred to the powering-up module. If a power failure event happens so that both modules are shut off, reset the time and date in the RMCT.

If you set and verify the date and time settings after a power loss, it helps with troubleshooting if an error or event occurs.

Verify System Qualification

After you have completed programming your redundant system and have downloaded your program to the primary controller, check the system status to verify that the system is qualified and synchronized.

TIP The system qualification process can take several minutes. After a qualification command or a switchover, allow time for qualification to complete before acting based on the qualification status.

Check Qualification Status Via Module Status Displays

You can view qualification status by using the status displays and indicators of the secondary redundancy module and the primary and secondary ControlNet® and EtherNet/IP™ communication modules.

Table 23 - Synchronized System

Primary Chassis Display		Secondary Chassis Display	
Redundancy Module	Communication Module	Redundancy Module	Communication Module
PRIM	PwQS	SYNC	QS

Table 24 - Qualifying System

Primary Chassis Display		Secondary Chassis Display	
Redundancy Module	Communication Module	Redundancy Module	Communication Module
PRIM and QFNG	PQgS	QFNG	QgS

Table 25 - System with a Primary and Disqualified Secondary

Primary Chassis Display		Secondary Chassis Display	
Redundancy Module	Communication Module	Redundancy Module	Communication Module
PRIM	PwDS	DISQ	Either: <ul style="list-style-type: none"> • CMPT (modules are compatible) • DSNP (no partner is present)

Example of Qualified and Disqualified Status Indicators

This example shows status display messages and status indicators that can appear differently depending on the qualification status of the redundant chassis. The following are only two examples of status display message and indicator combinations for both the qualified and disqualified states.

Qualified Redundant Chassis

Disqualified Redundant Chassis

Primary Chassis

Primary Chassis

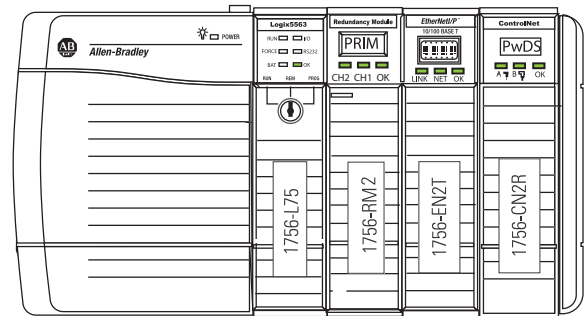
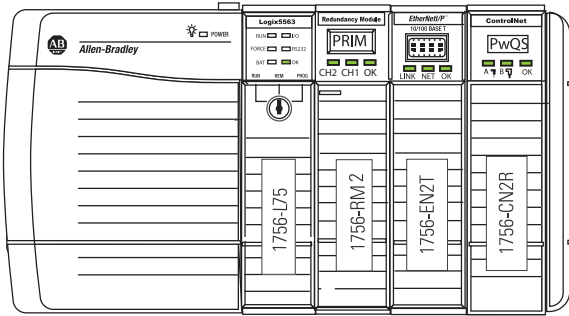

Secondary Chassis

Secondary Chassis

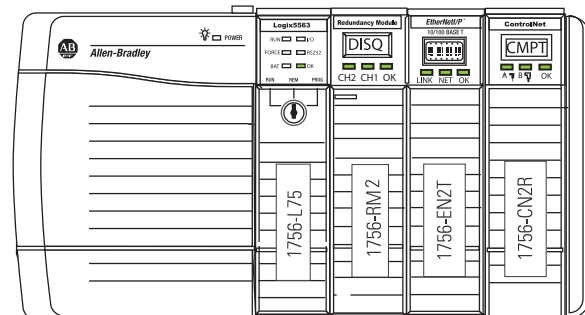
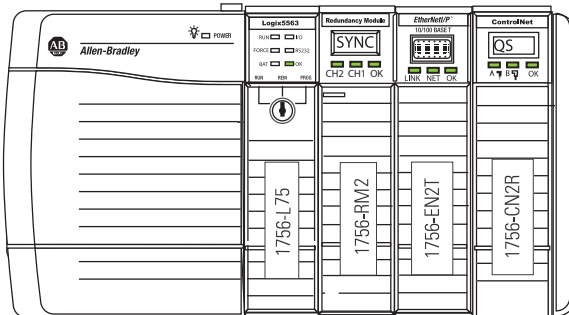

Check Qualification Status Via the RMCT

To determine the qualification status of your system by using the RMCT, open the RMCT and view the qualification status in the bottom-left corner of the tool.

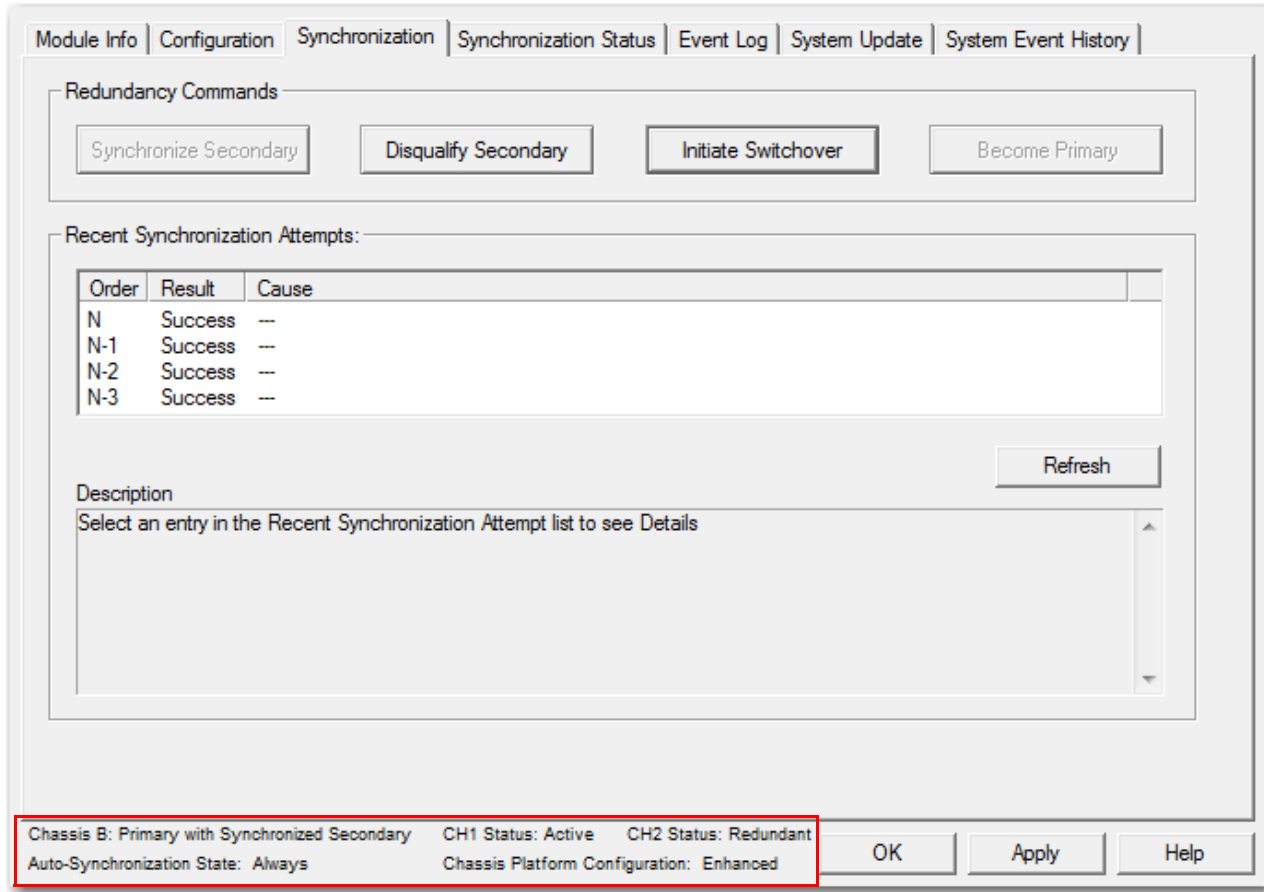

Check the EtherNet/IP Module Status

After you have programmed your redundant system and configured your EtherNet/IP network, check two statistics specific to your EtherNet/IP modules. These statistics include the CPU usage and the connections used.

To view the CPU usage and the number of connections that are used, complete these steps.

1. In RSLinx® Classic software, open the Module Statistics for the EtherNet/IP module.
2. Click the Connection Manager tab.

CPU Usage

The CPU usage of the EtherNet/IP modules must be at 80%, or less. CPU usage below 80% reserves enough CPU functionality for the EtherNet/IP module to facilitate a switchover.

If the CPU usage is above 80%, the secondary chassis can fail to synchronize with the primary chassis after a switchover occurs. In addition, unscheduled communication can be slowed.

If you must reduce the CPU usage of your EtherNet/IP modules, consider making the following changes:

- Adjust the Requested Packet Interval (RPI) of your connections.
- Reduce the number of devices that are connected to your module.
- Take steps to reduce your CPU utilization. See the EtherNet/IP Network Configuration User Manual, publication [ENET-UM001](#).

Connections Used

If the connections of your EtherNet/IP modules that are used are near the limits of the module, you can experience difficulty when attempting to go online with the system. This difficulty arises because going online with a processor also consumes a connection, if the attempts to go online are through the communication module that is near the limit. You can also experience difficulty when attempting to add modules to the system.

Monitor the EtherNet/IP Network

For most redundant applications, monitoring the status of the EtherNet/IP network is important for maintenance and troubleshooting.

Check the ControlNet Module Status

After you have programmed your redundant system and configured your ControlNet network, check two statistics specific to your ControlNet modules. These statistics include the CPU usage and the connections used.

To view the CPU usage and the number of connections that are used, complete these steps.

1. In RSLinx Classic software, open the Module Statistics for the ControlNet module.

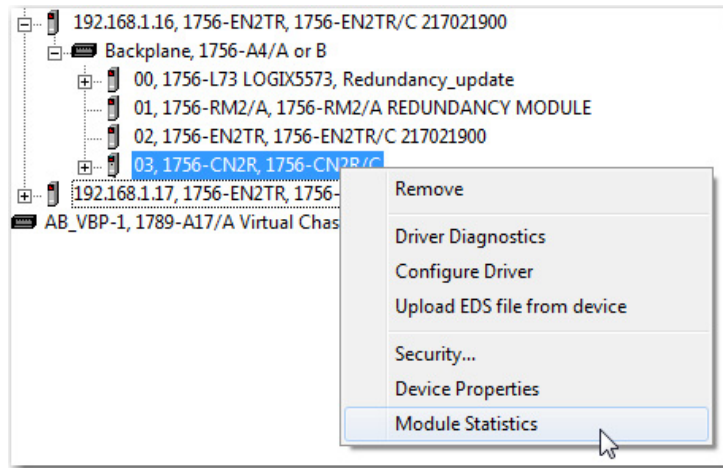

2. Click the Connection Manager tab.

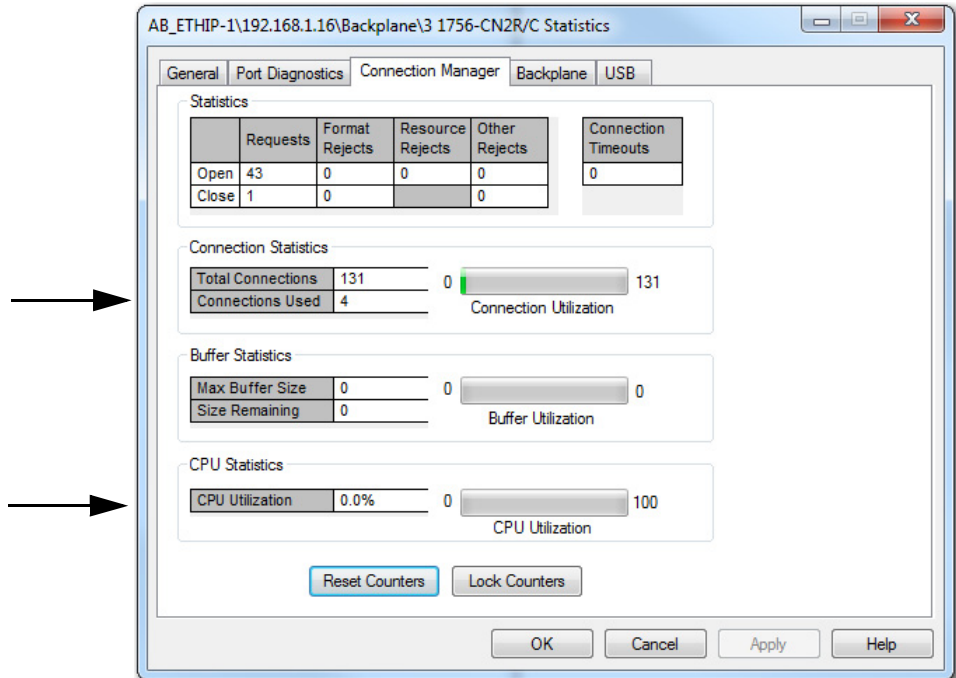

CPU Usage

The CPU usage of the ControlNet modules must be at 80%, or less. CPU usage below 80% reserves enough CPU functionality for the ControlNet module to facilitate a switchover.

If the CPU usage is above 80%, the secondary chassis can fail to synchronize with the primary chassis after a switchover occurs. In addition, unscheduled communication can be slowed.

If you must reduce the CPU usage of your ControlNet modules, consider making the following changes:

- Increase the Network Update Time (NUT) of the ControlNet network.
- Increase the Requested Packet Interval (RPI) of your connections.
- Reduce the number of connections through the ControlNet modules.
- Reduce the number of messages that are used in the program.

Connections Used

If the connections of your ControlNet modules that are used are near the limits of the module, you can experience difficulty when attempting to go online with the system. This difficulty arises because going online with a processor also consumes a connection. You can also experience difficulty when attempting to add modules to the system.

For information about connections available with ControlNet modules, see [ControlNet Network Requirements on page 30](#).

Monitor the ControlNet Network

For most redundant applications, monitoring the status of the ControlNet network is important for maintenance and troubleshooting.

For programming samples to monitor the ControlNet network, visit the Rockwell Automation® Sample Code Library at <http://samplecode.rockwellautomation.com>. Applicable sample programs include the following:

- ME Faceplates for ControlNet Diagnostics
- ControlNet Connection and Media Status

Notes:

Troubleshoot a Redundant System

Topic	Page
General Troubleshooting Tasks	169
Check the Module Status Indicators	170
Use Programming Software to View Errors	171
Event Log Tab	174
System Event History	184
Use the RMCT for Synchronization Attempts and Status	188
Use the RMCT Event Log	190
Keeper Status Causing Synchronize Failure	199
Partner Network Connection Lost	202
Redundancy Module Connection Lost	204
Redundancy Module Missing	205
Qualification Aborted Due to a Non-redundant Controller	206
Redundancy Module Status Indicators	207

General Troubleshooting Tasks

When an error or other event occurs on the redundancy system, several tasks can be executed to determine the cause. After an error or event, you can perform these tasks:

- Check the module status indicators.
- View diagnostic information in the programming software.
- Access status and event information in the RMCT.
- Use RSLinx® Classic software to view network status.
- Use RSNetWorx™ for ControlNet® software to view ControlNet network status.

Check the Module Status Indicators

If an error or event occurs in the redundancy system, check the module status indicators to determine which module is causing the error or event.

If any of the modules have status indicators that are steady or blinking red, then examine that module status display and the RMCT or other software to determine the cause.

Figure 48 - Steady or Flashing Red Indicators Indicate Errors on 1756-RM2/A or 1756-RM2XT Modules

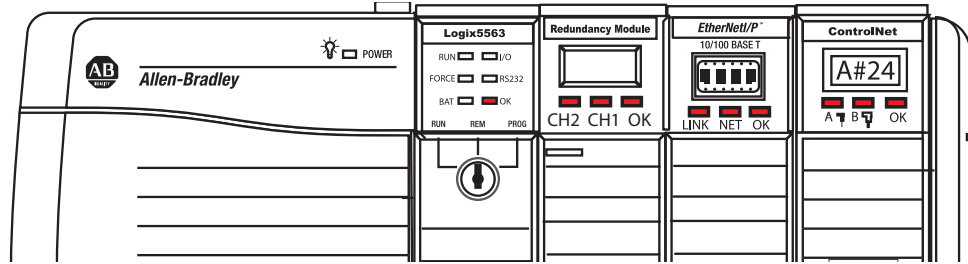
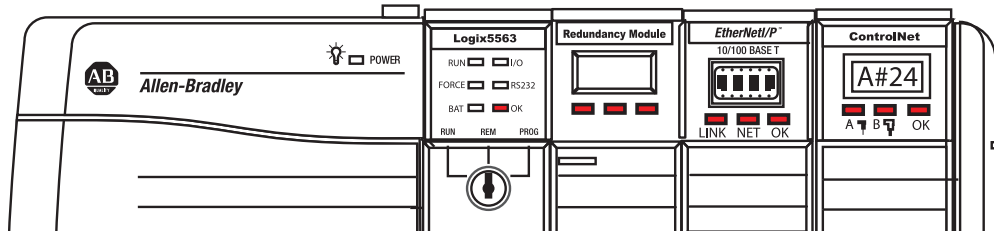

Figure 49 - Steady or Flashing Red Indicators Indicate Errors on 1756-RM/1756-RMXT Modules



For more information about module status indicators, see [Redundancy Module Status Indicators on page 207](#).

Figure 50 - Module Status Displays for Chassis with ControlLogix 5560 and ControlLogix 5570 Controllers

ControlLogix® 5560 Controller and 1756-RM Module

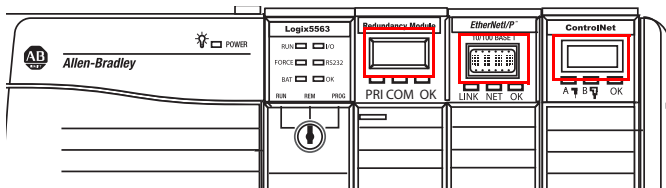

ControlLogix 5560 Controller and 1756-RM2/A Module

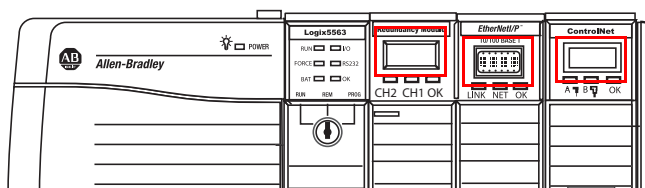

ControlLogix 5570 Controller and 1756-RM Module

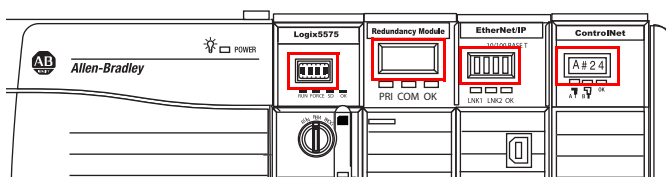

ControlLogix 5570 Controller and 1756-RM2/A Module

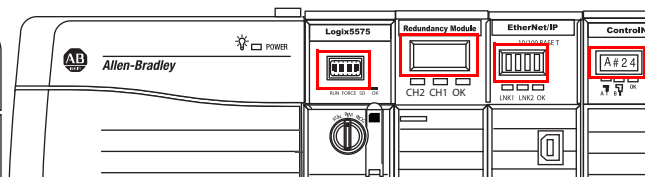

Use Programming Software to View Errors

To view redundancy status by using programming software, complete these steps.

1. Go online with the redundant controller.

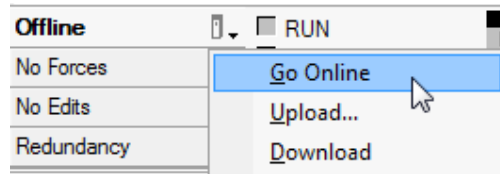

2. Either click Primary or Secondary, depending on the controller you are online with.

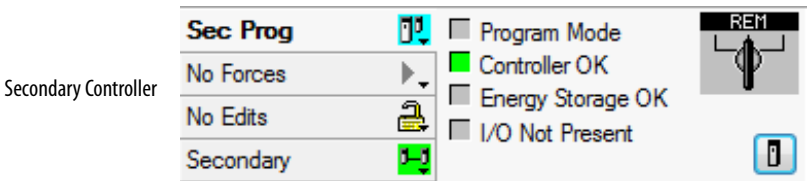
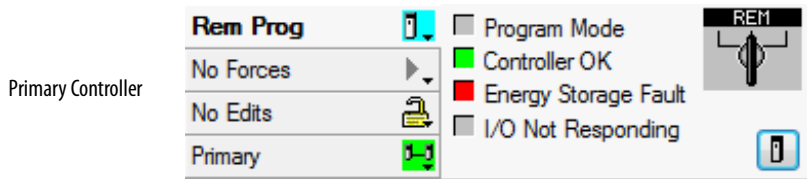

The redundant controller ID and status are displayed.

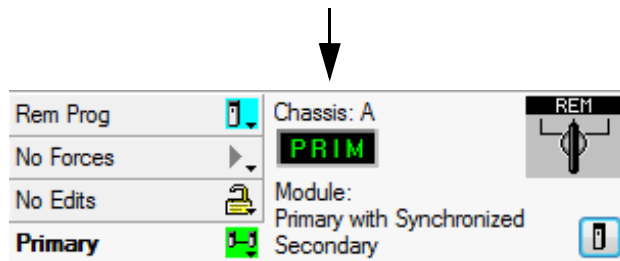

3. If further information is required, click Controller Properties.

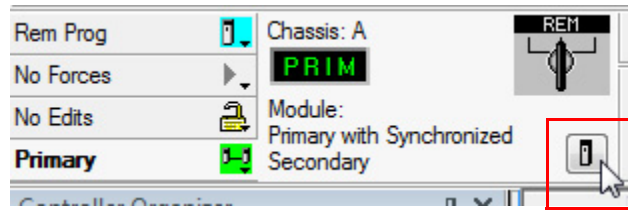

4. Click the Redundancy tab.

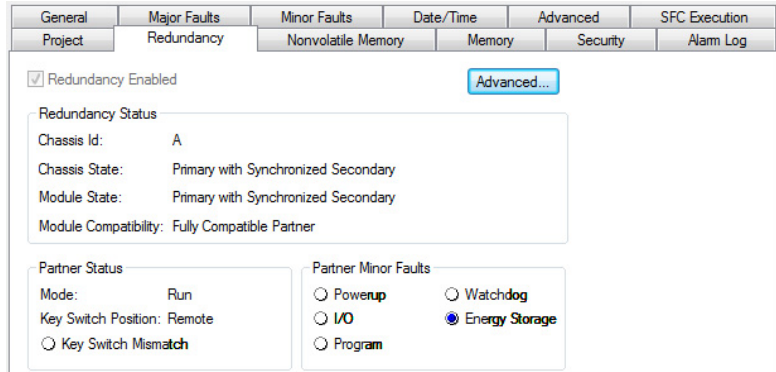

5. If controller fault details are needed, click the Major Faults and Minor Faults tabs to view fault types and codes.

These fault bits are status bits that the controller sets. You can set these fault bits for testing, but that is not the main purpose of these bits.

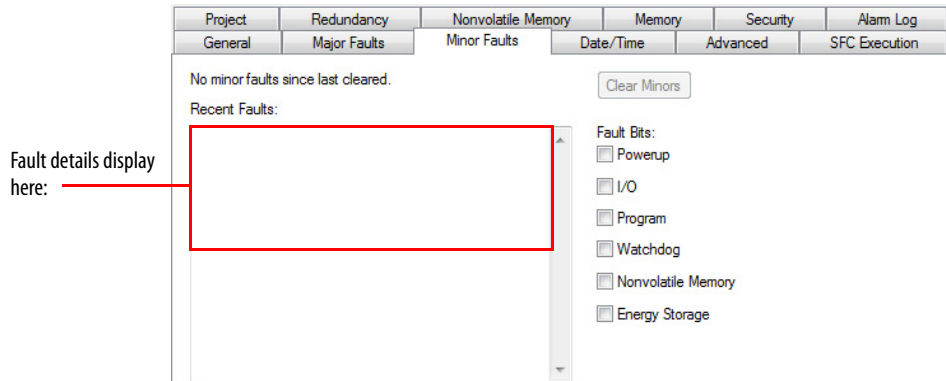

6. If necessary, reference these resources:

- [Redundant Controller Major Fault Codes](#)
- Logix 5000™ Controllers Major and Minor Faults Programming Manual, publication [1756-PM014](#) (describes all major and minor fault codes)

Redundant Controller Major Fault Codes

The fault codes that are listed and described in [Table 26](#) are specific to redundant controllers. For information about all controller major and minor fault codes, see the Logix 5000 Controllers Major, Minor, and I/O Faults Programming Manual, publication [1756-PM014](#).

Table 26 - Redundant Controller Major Fault Codes

Type	Code	Cause	Recovery Method
12	32	A disqualified secondary controller was power cycled and no partner chassis or controller was found upon powerup.	<p>Verify that these conditions exist:</p> <ul style="list-style-type: none"> • A partner chassis is connected. • Power is applied to both redundant chassis. • Partnered controllers have the same: <ul style="list-style-type: none"> – Catalog number – Slot number – Firmware revision
12	33	An unpartnered controller has been identified in the new primary chassis after a switchover.	<p>Use either of these methods:</p> <ul style="list-style-type: none"> • Remove the unpartnered controller and troubleshoot the cause of the switchover. • Add a partner controller to the secondary chassis, troubleshoot the cause of the switchover, and synchronize the system.
12	34	<p>Before switchover, a mode switch mismatch was present. The old primary controller was in Program mode and the mode switch of the secondary partner was in the Run position. Instead of the switchover transitioning the new primary controller to go to Run mode, the new primary controller transitions to a faulted state after the switchover.</p>	<p>Use either of these methods:</p> <ul style="list-style-type: none"> • Change the mode switches from Run mode to Program mode and back to Run mode twice to clear the fault. <p>Make sure that the mode switch positions for both controllers in a partnered set match.</p> <ul style="list-style-type: none"> • Use the programming software to go online with the controllers. Then, clear the faults and change the mode switch positions for both the controllers in the partnered set to Run.

Event Log Tab

IMPORTANT Messages in the Event Log are esoteric. These messages are for Rockwell Automation development engineering to debug redundancy system events after the fact. Anyone who is not part of the development engineering team can have difficulty interpreting the meaning of many of the events in the Event Log. For user facing messages, see [System Event History on page 184](#). These messages are designed for the user.

The Event Log tab provides a history of events that have occurred on the redundant chassis.

These system events are indicated in the event logs:

- Qualification stages that are entered and completed
- Module insertion/removal
- Firmware errors
- Communication events and errors
- Configuration changes
- Other system events that affect qualification and synchronization

IMPORTANT The events that are logged in this tab are not always indicative of an error. Many of the events that are logged are informational only. To determine if additional action or troubleshooting is required in response to an event, see [Table 28 on page 175](#).

The Event Log tab can be customized to view the log specific to only one chassis or the event logs of both redundant chassis. You can alter your view of the event logs by changing the Auto-Update and Partner Log parameters.

Table 27 - Settings for Event Log Views

Use This Setting	To
Auto-Update	Keep the log from updating while you are viewing it.
Partner Log	View only the event log for the module you are accessing.

Figure 51 - Settings for Event Log Views

Check On to keep the log updating automatically.

Check Close to view only the log of one redundancy module.

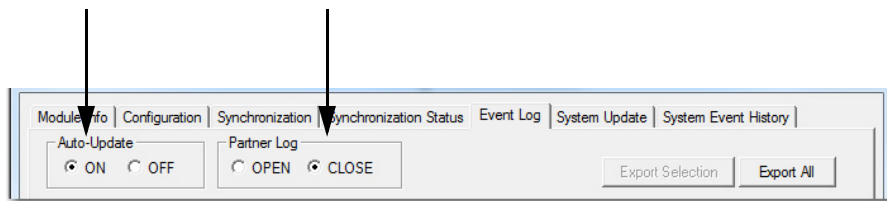

Event Classifications

Each event that is identified and logged is classified. You can use these classifications to identify the severity of the event and determine if additional action is required.

Figure 52 - Event Classifications in the Event Log Tab

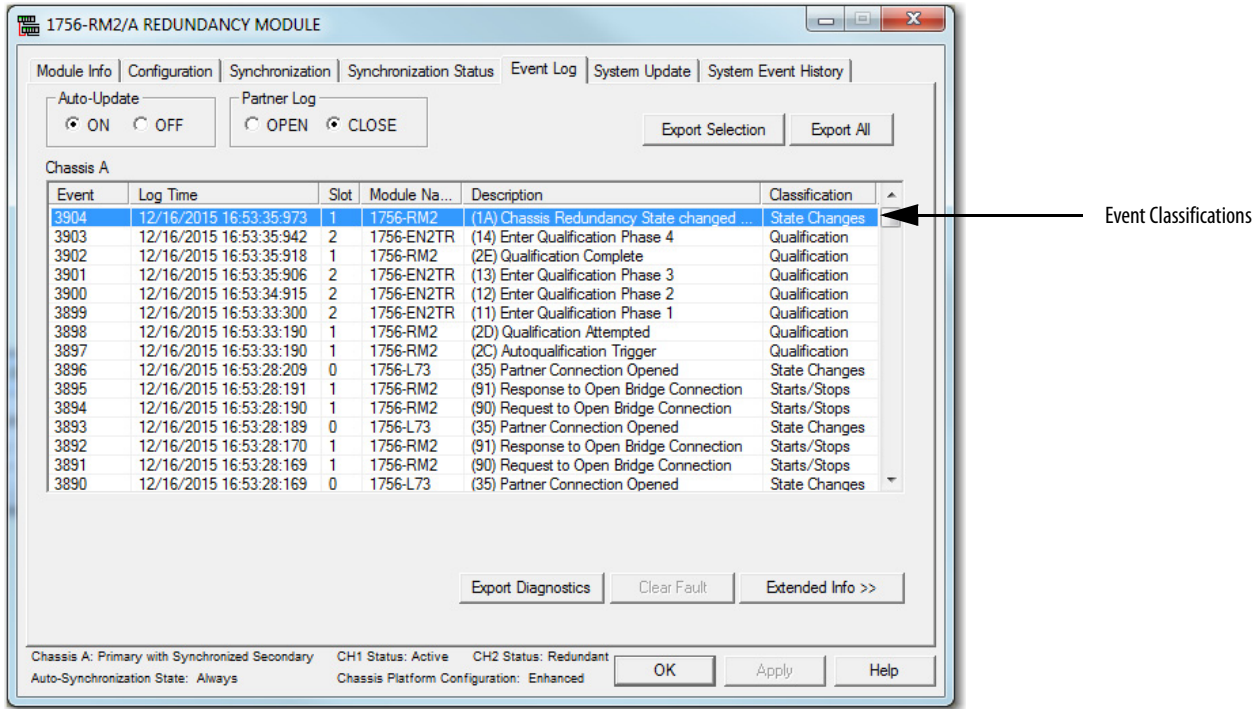

Use [Table 28](#) to determine what an event classification indicates and if corrective action is required.

Table 28 - Classification Types

Classification Type	Description	Action Required
Configuration	A redundancy module configuration parameter has been changed. For example, if you change the Auto-Synchronization parameter from Always to Never, an event that is classified as Configuration is logged.	No corrective action is required. This event is provided for informational purposes and does not indicate serious anomaly with the redundancy system.
Command	An event that is related to commands that are issued to the redundant system has occurred. For example, if you change the Redundancy Module Date and Time parameters, a WCT time change event of the Command classification is logged.	No corrective action is required. This event is provided for informational purposes and does not indicate serious anomaly with the redundancy system.
Failure	A failure on the redundancy module has occurred. For example, an internal Firmware error event that is classified as a Failure can be indicated in the event log.	Action can be required to determine the cause of the failure. If Switchover or Major Fault event does not precede a failure, then the module could have corrected the error internally and additional action is not required. To determine if corrective action is required, double-click the event to see Extended Event Information and the suggested recovery method, if applicable.
Major Fault	A major fault has occurred on one of the redundancy modules.	Action can be required to determine the action that is necessary to correct the fault. Double-click the event to see Extended Event Information and the suggested recovery method, if applicable.

Table 28 - Classification Types

Classification Type	Description	Action Required
Minor Fault	A minor fault has occurred on one of the redundancy modules.	No corrective action is required. This event is provided for informational purposes and does not indicate a serious anomaly with the redundancy system.
Starts/Stops	Various internal chassis and module processes have started or stopped.	No corrective action is required. However, if an event that is classified as a Failure, State Change, or Major Fault occurs after the Starts/Stops event, view the Extended Event Information of both events to determine if the events are related.
State Changes	A chassis or module state change has occurred. For example, if the chassis designation changes from being a disqualified secondary to a qualified secondary, a State Change event is logged.	No corrective action is required. However, if an event that is classified as a Failure, or Major Fault occurs after the State Changes event, view the Extended Event Information of both events to determine if the events are related.
Switchover	An event that is related to a chassis switchover has occurred. For example, if an Initiate Switchover command is issued, an event that is classified as Switchover is logged.	Action can be required to determine the cause of the switchover and potential correction methods. Double-click the event to see Extended Event Information and the suggested recovery method, if applicable.
Synchronization	An event that is related to chassis synchronization has occurred. For example, if the Synchronization command has been issued, a Network Transitioned to Attached event is logged and classified as Synchronization.	No corrective action is required. This event is provided for informational purposes and does not indicate a serious anomaly with the redundancy system.

Access Extended Information about an Event

Events that are logged in the Event Log tab can have additional information available. To access additional information about an event, double-click an event that is listed in the log.

Chassis A

Event	Log Time	Slot	Module Na...	Description	Classification
3904	12/16/2015 16:53:35:973	1	1756-RM2	(1A) Chassis Redundancy State changed ...	State Changes
3903	12/16/2015 16:53:35:942	2	1756-EN2TR	(14) Enter Qualification Phase 4	Qualification
3902	12/16/2015 16:53:35:918	1	1756-RM2	(2E) Qualification Complete	Qualification
3901	12/16/2015 16:53:35:906	2	1756-EN2TR	(13) Enter Qualification Phase 3	Qualification

↓ Double-click to open extended information.

Extended Information Definition - Chassis A

Event Information

Event Number	3901	Log Time	12/16/2015
Event Class	Qualification		

Submitter Information

Module Type	1756-EN2TR	Slot No	2
Serial No (in Hex)	A71816		

Event Details

Description: (13) Enter Qualification Phase 3

Extended Data Definition

Extended Information Unavailable

Extended Information Bytes (in Hex)

OK

View the Description and Extended Data Definitions.

Scroll to view details of other events.

Interpret Extended Information for an Event

The information that is listed in this table can be provided (depending on the type of event) after you have accessed the Extended Information Definition dialog box.

Information Type	Description
Event Information	The redundancy system assigns this event information: <ul style="list-style-type: none"> • Event number • Date and time the event occurred • Event classification
Submitter Information	This information reflects information specific to the module that reported the event. Information that is provided in this section includes the: <ul style="list-style-type: none"> • Name of the module that originated the event • Slot number of the module that originated the event • Serial number of the module that originated the event
Event Details	This section provides these additional details about the event: <ul style="list-style-type: none"> • Description of the event • Examine the Extended Data Definition, which provides an explanation of the event and bytes, for errors • Extended Data Bytes (in Hexadecimal) that provides further details the event

Export Event Log Data

After you have viewed extended information about an event, you could need to export event data. You can export data with either of these features:

- Export Selection
- Export All - Available with redundancy system, Revision 19.052 or later

Export Selection

Use this feature to export event log data for single or multiple events that occur on a primary or secondary redundancy module.

Complete these steps to export event data for an event.

TIP If the redundancy modules are not available in RSLinx® Classic software after a fault, you must apply the recovery method that the module indicates before attempting to export the Event Log data.

1. Launch RSLinx Classic communication software and browse to the redundancy modules.
2. Right-click the **primary** redundancy module and choose Module Configuration.

- In the Auto-Update area, click Off to keep the log from updating.

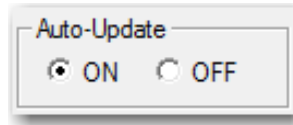

- In the Partner Log area, click Close.

This action closes the event log of the partner module.

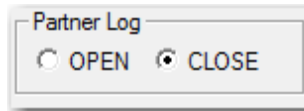

- Select one event or multiple events for which you want to export data. To select multiple events, select a start event, press SHIFT, and select an end event.

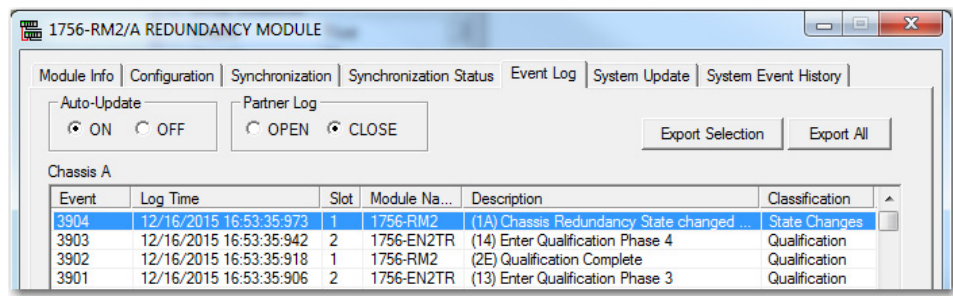

- Click Export Selection.

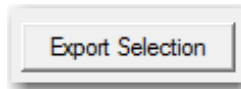

The Export Event Log dialog box opens.

- Complete these steps on the Export Event Log dialog box.
 - Specify a file name and location or use the default name and location.
 - Check CSV (Comma-Separated Value).

TIP If you are sending the exported Event Log files to Rockwell Automation Technical Support, you must use the CSV file type.

- Check Include Extended Information.

TIP If you are sending the exported Event Log files to Rockwell Automation Technical Support, include the diagnostic data and extended information.

If you include this data, Rockwell Automation Technical Support can analyze module and system failures more effectively.

8. Click Export.

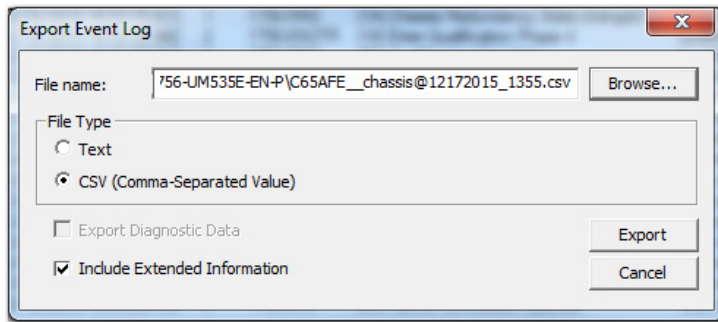

The event log is exported. The log can take a few minutes to export.

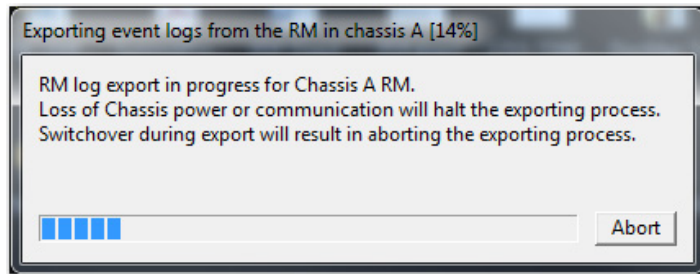

9. If you want to export the secondary redundancy module log for a complete system view complete [step 1...step 8](#).

IMPORTANT If you are exporting event data to provide to Rockwell Automation Technical Support to troubleshoot an anomaly, you must obtain the event logs for both the primary and secondary redundancy modules. Rockwell Automation Technical Support needs the event logs to troubleshoot the anomaly.

If you cannot access the event log for the secondary redundancy module, export it from the partner event log via the primary redundancy module. We recommend that you get the logs by choosing export all with the CSV file type.

Keep in mind, though, that the view the primary redundancy module has of the event log of the secondary redundancy module is typically limited. To troubleshoot an anomaly with Rockwell Automation Technical Support, you must obtain the event log of the secondary redundancy module from the view of the module itself.

Export All

Use this feature to export all available event log data for events in both of the redundancy modules of the redundant chassis pair automatically.

We recommend that you use this feature when troubleshooting system-related anomalies, where the location of a fault could have occurred a lengthy period before the current event.

Complete these steps to export event log data for one event.

TIP If the redundancy modules are not available in RSLinx Classic software after a fault, you must apply the recovery method that the module indicates before attempting to export the Event Log data.

1. Launch RSLinx Classic communication software and browse to the redundancy modules.
2. Right-click the **primary** redundancy module and choose Module Configuration.
3. On the Event Log tab, click Export All.



4. At the Export All dialog box, click OK.
5. At the RSLinx Classic window, select the redundancy module in the partner redundant chassis.
6. Complete these steps on the Export Event Log dialog box and click OK.
 - a. Specify a file name and location or use the default name and location.
 - b. Check CSV (Comma-Separated Value).

TIP If you are sending the exported Event Log files to Rockwell Automation Technical Support, you must use the CSV file type.

- c. Check Export Diagnostic Data.
- d. Check Include Extended Information.

TIP If you are sending the exported Event Log files to Rockwell Automation Technical Support, include the diagnostic data and extended information. If you include this data, Rockwell Automation Technical Support can analyze module and system failures more effectively.

7. Click Export.

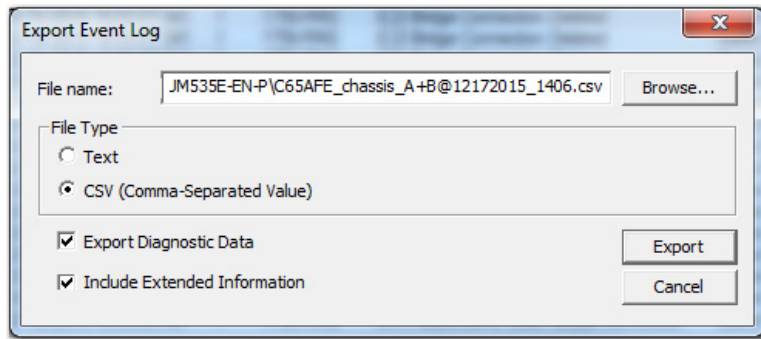

The event log is exported. The log can take a few minutes to export.

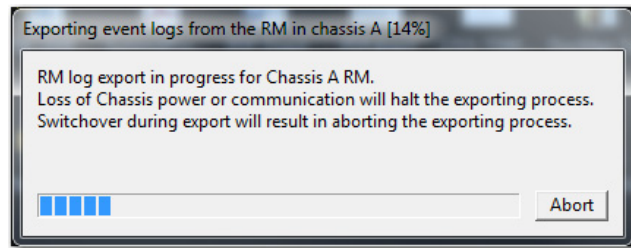

Wait for this dialog box to appear.

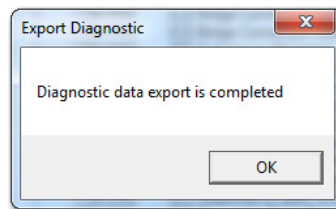

8. Click OK.

A .csv and a .dbg file is in the folder location specified. Make sure to provide the .csv file to Rockwell Automation Technical Support when troubleshooting an anomaly.

Clear a Fault

You can use the Clear Fault feature on the Event Log tab to clear major faults that occur on a redundancy module.

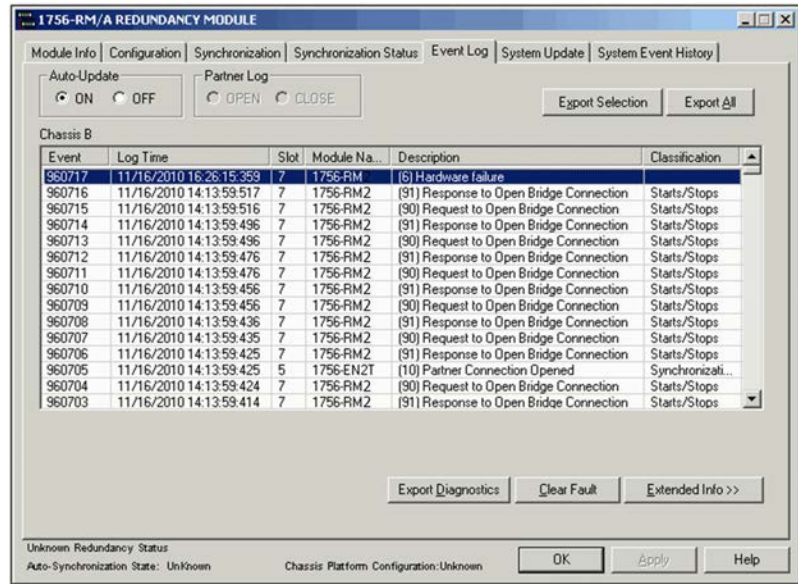

With this feature, you can remotely restart the redundancy module without physically removing and reinserting it from the chassis. The module restart clears the fault.

IMPORTANT Export all event and diagnostic data from the module before you clear major faults from the module. Clear Fault is active only when the redundancy module is in a major faulted state.

Module faults are displayed on the Module Info tab. This example graphic shows information for a module that has experienced a minor fault.

Fault details display here:

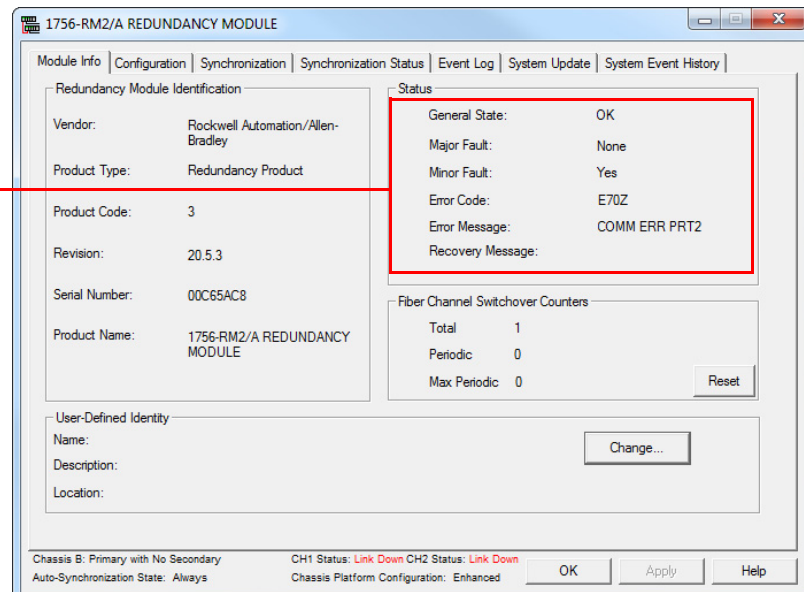

System Event History

The System Event History tab is designed to give a user with limited knowledge of ControlLogix Redundancy systems an event history.

These events include the following:

- Qualification - The ControlLogix Redundancy system can now switchover to the secondary redundancy chassis if necessary.
- Disqualification - The secondary redundancy chassis is not ready to accept control of the system. The ControlLogix Redundancy system cannot switchover.
- Switchovers - The secondary chassis has now become the primary chassis and is now controlling the system.
- Module faults - A module has faulted in the ControlLogix Redundancy system.

The last 20 events are logged in the System Event History tab. There are 10 events from each redundancy module.

System Event History Column Descriptions

For each event logged, this information is provided:

- Attempt - Event count, this will range from N to N-19 for the maximum of 20 events.
- Initiation Time - The time and date of the event from the redundancy module clock
- Event Class - Qualification, Disqualification, or RM FAULT (Redundancy Module fault)
- Basic Info - Information about the origin of the event (for example, Commanded or Auto Qualification)
- Extended Info-A - A short text description of the event
- Extended Info-B - Additional details on the event
- User Comment - An editable user comment for the event

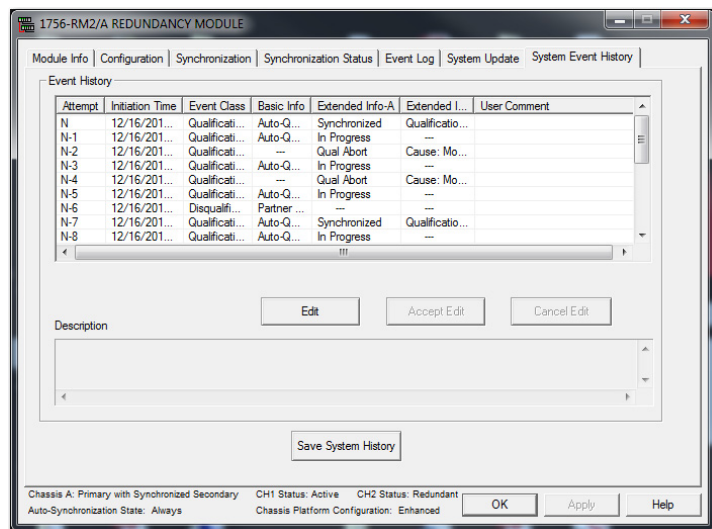

Edit a User Comment for a System Event

To edit the User Comment that is associated with a system event, complete these steps.

1. Select the event.
2. Click Edit.
3. In the Description field, type your event description.

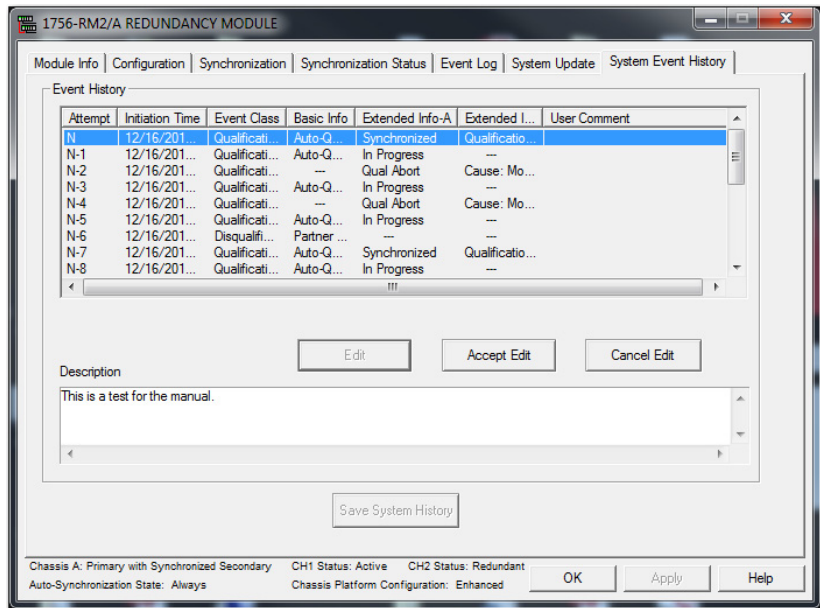

4. Click Accept Edit.
5. At the Accept Edit dialog box, click OK.

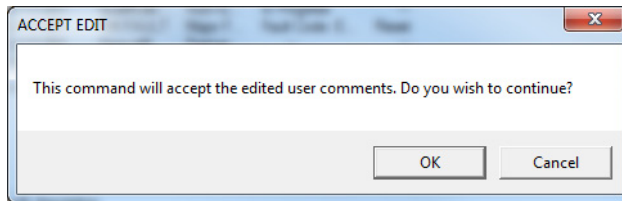

Save System Event History

If you want to save the system event log to the nonvolatile memory of the redundancy module, click Save System History at the bottom of the System Event tab. If you save this history, it can assist with troubleshooting the system later.

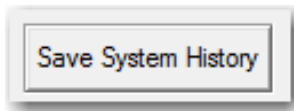

Event Examples

This section contains System Event History records for typical system events. The examples in this section are from Firmware Enhanced Redundancy Bundle V20.056_kit1, RMCT version 8.2.1.0.

Table 29 - Manual Switchover

Event Class	Basic Info	Extended Info-A	Extended Info-B
Switchover	Comanded	–	–

Table 30 - Disqualify Secondary

Event Class	Basic Info	Extended Info-A	Extended Info-B
Disqualification	Comanded	–	–

Table 31 - Qualification Successful

Event Class	Basic Info	Extended Info-A	Extended Info-B
Qualification	Auto-Qualification	Synchronized	Qualification Complete
Qualification	Auto-Qualification	In Progress	–

Table 32 - Qualification Failed Due to Incompatible Module

Event Class	Basic Info	Extended Info-A	Extended Info-B
Qualification	Auto-Qualification	In Progress	–
Qualification	–	Qual Abort	Cause: module pairs are incompatible

Table 33 - Switchover Due to Module Removal from Primary

Event Class	Basic Info	Extended Info-A	Extended Info-B
Disqualification	Module Fault	Chassis B	SYS_FAIL_L Asserted in Secondary Chassis
Switchover	Module Removal	Chassis B - Slot No:2	–

Table 34 - Switchover Due to Network Cable Removal in Primary

Event Class	Basic Info	Extended Info-A	Extended Info-B
Switchover	Module Fault	Chassis B - Slot No: xx ⁽¹⁾	Possible Causes: 1. Network cable removal 2. Controller program fault

(1) xx = module slot number.

Table 35 - Switchover Due to Chassis Power Fault in Primary Chassis

Event Class	Basic Info	Extended Info-A	Extended Info-B
Switchover	Partner RM Power Failure	–	–

Table 36 - Disqualification Due to Network Connection Lost between Primary and Secondary Chassis

Event Class	Basic Info	Extended Info-A	Extended Info-B
Switchover	Module Fault	Chassis B - Slot No: xx ⁽¹⁾	Possible Causes: 1. Network Cable Removal ⁽²⁾ 2. Controller Program Fault

(1) xx = module slot number.

(2) This lost connection is not a network cable removal issue. The communication modules not being able to see each other over the network has caused the lost connection.

Table 37 - Disqualification Due to Partner Chassis Power Fault

Event Class	Basic Info	Extended Info-A	Extended Info-B
Disqualification	Partner RM Power Failure	–	–

Table 38 - Disqualification Due to Partner Chassis Module Removal

Event Class	Basic Info	Extended Info-A	Extended Info-B
Disqualification	Module Removal	Chassis A - Slot No: xx ⁽¹⁾	–

(1) xx = module slot number.

Table 39 - Disqualification Due to Partner Chassis Redundancy Module Fault

Event Class	Basic Info	Extended Info-A	Extended Info-B
RM FAULT	Major Fault	Fault Code: EE05	Reset
Disqualification	Partner RM Power Failure	–	–

Table 40 - Disqualification Due to Redundancy Module Fiber Cable Disconnected or Faulted

Event Class	Basic Info	Extended Info-A	Extended Info-B
Disqualification	RM Fiber Cable Disconnect	–	–

Use the RMCT for Synchronization Attempts and Status

When troubleshooting your redundant system for anomalies with qualification and synchronization, check the Synchronization and Synchronization Status tabs of the RMCT.

Recent Synchronization Attempts

The Synchronization tab provides a log of the last four synchronization attempts. If a synchronization command was unsuccessful, the Recent Synchronization Attempts log indicates a cause.

For more information about how to resolve the synchronization conflict, click the attempt and view the Description in the lower box.

Figure 53 - Example of an Unsuccessful Synchronization Attempt

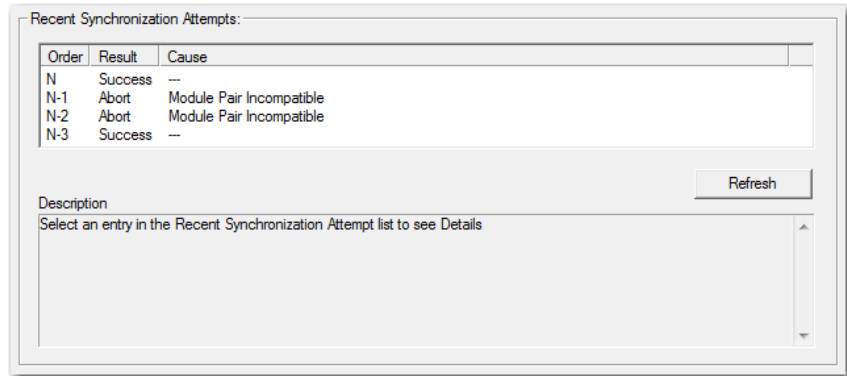

For more information about how to interpret the Recent Synchronization attempts log, see [Recent Synchronization Attempts Log on page 101](#).

Module-level Synchronization Status

The Synchronization Status tab provides a module-level view of redundant chassis and can be used to identify what module pair can be causing a synchronization failure.

Depending on the type of synchronization failure, you can need to open the Synchronization Status tabs for the primary and secondary redundancy modules.

- If there is a difference between major revisions of the controllers or modules, the Compatibility column shows **Incompatible**, as shown in this graphic.

Primary Chassis

Slot	% Complete	Module Name	Module Revision	Secondary Readiness	State	Compatibility
0	0	1756-L73/A LOGIX5573	20.55	No Partner	Primary	Incompatible
1	0	1756-RM2/A REDUNDAN...	20.5	Disqualified	Primary	Full
2	0	1756-EN2TR/C 217021900	10.7	Disqualified	Primary	Full
3	0	1756-CN2R/C	25.5	Disqualified	Primary	Full

Secondary Chassis

Slot	% Complete	Module Name	Module Revision	Secondary Readiness	State	Compatibility
0	0	DB_1756-L73/A INT_7xR...	24.50	No Partner	Secondary	Incompatible
1	0	1756-RM2/A REDUNDAN...	20.5	Disqualified	Secondary	Full
2	0	1756-EN2TR/C 217021900	10.7	Disqualified	Secondary	Full
3	0	1756-CN2R/C	25.5	Disqualified	Secondary	Full

- If there is a difference between minor revisions of the controllers or modules, the Compatibility column also shows **Incompatible**, as shown in the following graphic.

Primary Chassis

Slot	% Complete	Module Name	Module Revision	Secondary Readiness	State	Compatibility
0	0	1756-L73/A LOGIX5573	20.55	No Partner	Primary	Incompatible
1	0	1756-RM2/A REDUNDAN...	20.5	Disqualified	Primary	Full
2	0	1756-EN2TR/C 217021900	10.7	Disqualified	Primary	Full
3	0	1756-CN2R/C	25.5	Disqualified	Primary	Full

Secondary Chassis

Slot	% Complete	Module Name	Module Revision	Secondary Readiness	State	Compatibility
0	0	1756-L73/A LOGIX5573	20.56	No Partner	Secondary	Incompatible
1	0	1756-RM2/A REDUNDAN...	20.5	Disqualified	Secondary	Full
2	0	1756-EN2TR/C 217021900	10.7	Disqualified	Secondary	Full
3	0	1756-CN2R/C	25.5	Disqualified	Secondary	Full

Use the RMCT Event Log

When troubleshooting your redundant system, access the Event Log to determine the cause of an event, error, switchover, or major fault.

Interpret Event Log Information

Use this procedure to view and interpret Event Log information.

1. Open the RMCT and click the Event Log tab.

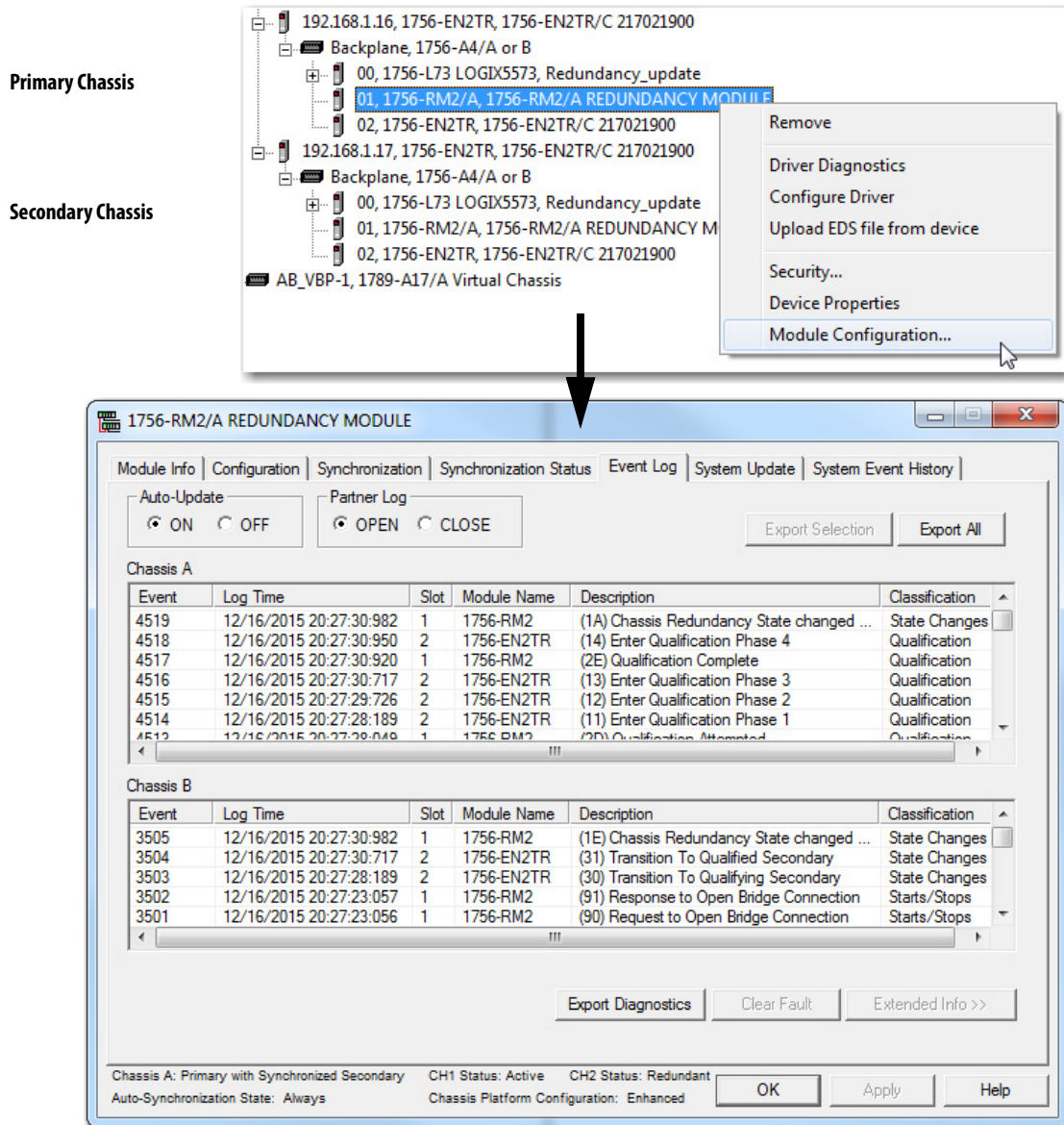

2. If an event occurred, open the Event Log for both chassis (A and B).
3. Locate the Event line that shows the qualification code, start date, and time of the event, in the A chassis event log.

This entry is the last time the redundancy module was working properly.

Multiple codes could be displayed if multiple errors occurred. Additionally, if a secondary redundancy module is not present, then a code can fail to be seen at all. See [Table 41 on page 193](#).

4. Then, locate the matching time entry in the B chassis event log. This entry displays the disqualification code on the Event line.

Chassis A

PwQS and start date and start time in Chassis A. This is the last time the redundancy module was working properly. →

Event	Log Time	Slot	Module No...	Description	Classific
27026	12/17/2015 10:56:03:530	1	1756-RM2	(1A) Chassis Redundancy State changed to PwQS	State Cl
27025	12/17/2015 10:56:03:400	2	1756-EN2TR	(14) Enter Qualification Phase 4	Qualific
27024	12/17/2015 10:56:03:400	3	1756-CN2R	(21) Equally Able To Control	State Cl
27023	12/17/2015 10:56:03:399	3	1756-CN2R	(14) Enter Qualification Phase 4	Qualific
27022	12/17/2015 10:56:03:377	1	1756-RM2	(2E) Qualification Complete	Qualific
27021	12/17/2015 10:56:03:375	3	1756-CN2R	(13) Enter Qualification Phase 3	Qualific

Chassis B

QSwP and start date and start time in Chassis B. This is the last time the redundancy module was working properly, and by time, must match up with Chassis A. →

Event	Log Time	Slot	Module No...	Description	Classific
11811	12/17/2015 10:56:03:375	1	1756-RM2	(1E) Chassis Redundancy State changed to QSwP	State Cl
11810	12/17/2015 10:56:03:375	3	1756-CN2R	(31) Transition To Qualified Secondary	State Cl
11809	12/17/2015 10:56:03:374	2	1756-EN2TR	(31) Transition To Qualified Secondary	State Cl
11808	12/17/2015 10:56:01:350	3	1756-CN2R	(30) Transition To Qualifying Secondary	State Cl
11807	12/17/2015 10:56:01:350	2	1756-EN2TR	(30) Transition To Qualifying Secondary	State Cl

5. Work back in time (up the lines of preceding events), to locate the point that a switchover or disqualifying event occurred.

This is the end date and time of the event, and is indicated on the Event line in the A chassis event log, with a disqualification code that the secondary has been disqualified, and a corresponding disqualification code in the B chassis event log. Again, if no secondary is present, the event log can display no secondary disqualification codes at all. See [Table 41 on page 193](#).

Chassis A

PwDS and end date and end time in Chassis A. This is the time the redundancy module experienced a disqualifying event or switchover. →

Event	Log Time	Slot	Module No...	Description	Classific
26984	12/17/2015 10:55:37:657	1	1756-RM2	(C) Port2 Communication error	Minor Fe
26983	12/17/2015 10:55:35:616	1	1756-RM2	(19) Chassis Redundancy State changed to PwDS	State Cl
26982	12/17/2015 10:55:35:330	3	1756-CN2R	(1) Network Transition to Not Attached	Synchi
26981	12/17/2015 10:55:35:496	1	1756-RM2	(31) Switchover Complete	Switch
26980	12/17/2015 10:55:35:495	3	1756-CN2R	(2) Network Not Attached Warning	Synchi

Chassis B

DSwP and matching end date and end time in Chassis B. This is the time the redundancy module experienced a disqualifying event or switchover. →

Event	Log Time	Slot	Module No...	Description	Classific
11787	12/17/2015 10:55:37:795	1	1756-RM2	(C) Port2 Communication error	Minor Fe
11786	12/17/2015 10:55:35:616	1	1756-RM2	(1D) Chassis Redundancy State changed to DSwP	State Cl
11785	12/17/2015 10:55:35:614	1	1756-RM2	(31) Switchover Complete	Switch
11784	12/17/2015 10:55:35:593	1	1756-RM2	(L2) Bridge Connection Deleted	Starts/S
11783	12/17/2015 10:55:35:593	1	1756-RM2	(C2) Bridge Connection Deleted	Starts/S

- To find the error that caused the disqualification, examine the range of time in between the start of the event and the end of the event.

IMPORTANT This range of time can be large depending on how much time has passed since the last disqualifying event.

The top screenshot shows the 'Event Log' window for Chassis B. The 'Event Log' tab is selected. The table below shows the event log entries:

Event	Log Time	Slot	Module Na...	Description	Classific
11846	12/17/2015 11:13:21:002	1	1756-RM2	(90) Request to Open Bridge Connection	Starts/S
11845	12/17/2015 11:13:01:370	1	1756-RM2	(4D) WCT time change (> 1 second)	Commarr
11844	12/17/2015 11:12:17:274	1	1756-RM2	(1D) Chassis Redundancy State changed to DSwp	State Cr
11843	12/17/2015 11:12:17:274	1	1756-RM2	(BC) Chassis Platform Identity Updated	Configur
11819	12/17/2015 10:39:31:893	1	1756-RM2	(7) Firmware error	Minor Fe
11818	12/17/2015 10:39:11:387	1	1756-RM2	(7) Firmware error	Minor Fe
11817	12/17/2015 10:39:10:888	1	1756-RM2	(7) Firmware error	Minor Fe
11816	12/17/2015 10:39:08:388	1	1756-RM2	(FF) Firmware Diagnostic Entry	Minor Fe
11815	12/17/2015 10:39:08:388	1	1756-RM2	(FF) Firmware Diagnostic Entry	Minor Fe
11814	12/17/2015 10:38:37:291	1	1756-RM2	(D2) CH2 Link Up	Minor Fe
11813	12/17/2015 10:38:37:195	1	1756-RM2	(C) Port2 Communication error	Minor Fe
11812	12/17/2015 10:38:37:195	1	1756-RM2	(C) Port2 Communication error	Minor Fe
11811	12/17/2015 10:56:03:530	1	1756-RM2	(1E) Chassis Redundancy State changed to QSwP	State Cr
11810	12/17/2015 10:56:03:375	3	1756-CN2R	(31) Transition To Qualified Secondary	State Cr

The bottom screenshot shows the 'Event Log' window for Chassis B. The 'Event Log' tab is selected. The table below shows the event log entries:

Event	Log Time	Slot	Module Na...	Description	Classifica
11967	12/17/2015 13:48:00:839	1	1756-RM2	(C2) Bridge Connection Deleted	Starts/St
11966	12/17/2015 13:48:00:819	1	1756-RM2	(C2) Bridge Connection Deleted	Starts/St
11965	12/17/2015 13:48:00:804	1	1756-RM2	(1D) Chassis Redundancy State changed to DSwp	State Ch
11964	12/17/2015 13:48:00:799	1	1756-RM2	(C2) Bridge Connection Deleted	Starts/St
11963	12/17/2015 13:48:00:783	1	1756-RM2	(C2) Bridge Connection Deleted	Starts/St
11962	12/17/2015 13:48:00:781	1	1756-RM2	(C2) Bridge Connection Deleted	Starts/St
11961	12/17/2015 13:48:00:780	1	1756-RM2	(C2) Bridge Connection Deleted	Starts/St
11960	12/17/2015 13:48:00:780	1	1756-RM2	(C2) Bridge Connection Deleted	Starts/St
11959	12/17/2015 13:48:00:779	3	1756-CN2R	(F) Partner Connection Closed	Synchronr
11958	12/17/2015 13:48:00:779	2	1756-EN2TR	(F) Partner Connection Closed	Synchronr
11957	12/17/2015 13:48:00:778	1	1756-RM2	(45) SYS_FAIL_L Active	Failure
11956	12/17/2015 13:48:00:777	2	1756-EN2TR	(1) Network Transition to Not Attached	Synchronr
11955	12/17/2015 11:44:12:697	1	1756-RM2	(1E) Chassis Redundancy State changed to QSwP	State Ch
11954	12/17/2015 11:44:12:534	2	1756-EN2TR	(31) Transition To Qualified Secondary	State Ch

TIP You can also use the Log Time column to identify a significant event. Scan within a time range that corresponds to the time an event was reported or annunciated.

In addition, you can also attempt to identify events by finding differences between times logged. Such gaps in time often identify events that require troubleshooting. When troubleshooting by identifying gaps in the time entries, remember that gaps in months, days, or minutes can indicate a significant change to the system.

Not all events that are logged are indicative of an anomaly that must be corrected. For example, events that are classified as Minor Faults do not warrant corrective behavior unless they occur just before a switchover, major fault, or state change **and** can be identified as contributing to successive events.

- After you have located an event entry that is related to the anomaly you are troubleshooting, double-click the event to view Extended Event Information.

Chassis B

Event	Log Time	Slot	Module Na...	Description	Classifica
12063	12/17/2015 13:54:48:462	1	1756-RM2	(C) Port2 Communication error	Minor Fau
12062	12/17/2015 13:54:48:373	3	1756-CN2R	(0) Network Transition to Attached	Synchron
12061	12/17/2015 13:54:45:263	1	1756-RM2	(1D) Chassis Redundancy State changed to DSwp	State Ch
12060	12/17/2015 13:54:45:259	1	1756-RM2	(31) Switchover Complete	Switchover
12059	12/17/2015 13:54:45:238	1	1756-RM2	(C2) Bridge Connection Deleted	Starts/St
12058	12/17/2015 13:54:45:238	1	1756-RM2	(C2) Bridge Connection Deleted	Starts/St
12057	12/17/2015 13:54:45:238	1	1756-RM2	(C2) Bridge Connection Deleted	Starts/St

↓ Double-click to view more information.

Extended Information Definition - Chassis B

Event Information

Event Number: 12061 Log Time: 12/17/2015

Event Class: State Changes

Submitter Information

Module Type: 1756-RM2 Slot No: 1

Serial No. (in Hex): C65AC8

Event Details

Description: (1D) Chassis Redundancy State changed to DSwp

Extended Data Definition

Extended Information Unavailable

The Description provides more information about the state change that occurred. →

No recovery method is described. This indicates that action is not required in response to this event. →

- View the Description and Extended Data Definitions.

The Description and Extended Data Definitions can be used to obtain further event information and can indicate a recovery method.

Table 41 - Possible Qualification Status Indicators

Status Code	Description
PwQS	Primary with qualified (synchronized) secondary partner
QSwP	Qualified (synchronized) secondary with primary partner
DSwP	Disqualified secondary with primary partner
DSwNP	Disqualified secondary with no partner
PwDS	Primary with disqualified secondary partner
PwNS	Primary with no secondary partner

Export All Event Logs

To export event logs with the RMCT version 8.3.1.0, follow these steps.

1. Open the RMCT on the 1756-RM2 module in the primary chassis and click the Event Log tab.
2. Click Export All.

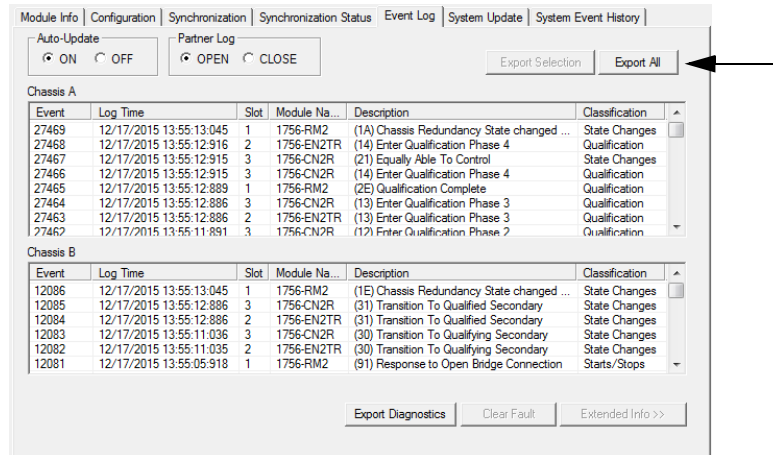

The Export All dialog box appears.

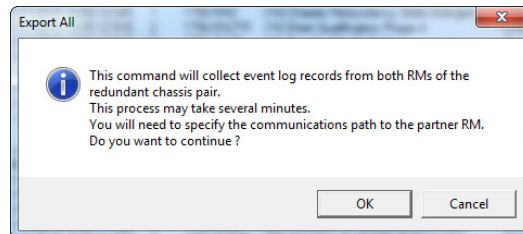

3. Click OK.
4. Select the communication path to the partner 1756-RM2 module with RSLinx Classic.

The Export Event Log configuration screen appears.

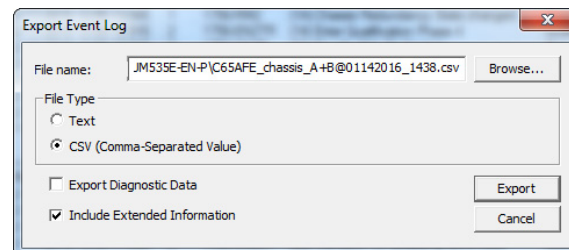

5. To change the file name or save location to something other than the default, select the Browse button.
6. Click Export.

7. Select the 1756-RM2 in the secondary chassis.

In the following example, chassis B is the secondary chassis.

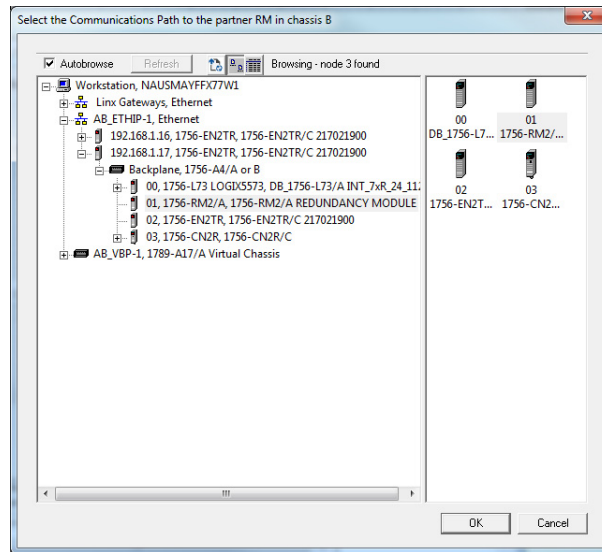

The primary chassis exports first.

In the following example, chassis A is the primary chassis.

The status displays during export.

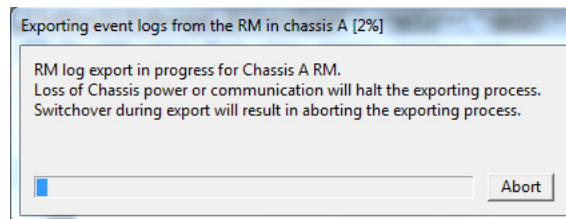

The secondary chassis then exports.

In the following example, chassis B is the secondary chassis.

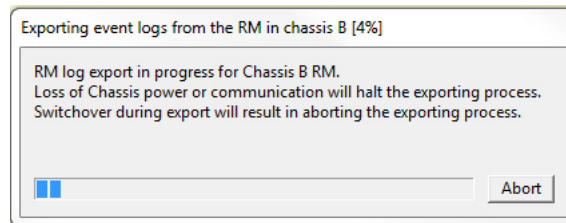

A confirmation dialog box displays when the export completes.

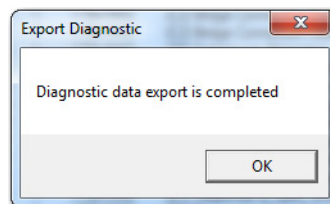

8. Click OK.

Export Diagnostics

IMPORTANT Only Export Diagnostics when requested to do so by Rockwell Automation Technical Support.

You can also click Export Diagnostics if there is a module fault in the redundancy module. Click Export Diagnostics to collect and save diagnostic data from the redundancy module and its partner, if an unrecoverable firmware fault occurs. A red 'OK' light on the front of the redundancy module indicates a nonrecoverable fault, and a fault message scrolls across the marquee display. When you click Export Diagnostics, information is recorded that Rockwell Automation engineering can use to determine the cause of the fault.

Because diagnostic information is recorded for the redundancy module and its redundancy partner, a communication path to the partner redundancy module is also part of the process to obtain the diagnostics.

Follow these steps.

1. Click Clear Fault if it is enabled, as it can first be necessary to clear any faults before using Export Diagnostics.
2. Click Export Diagnostics.

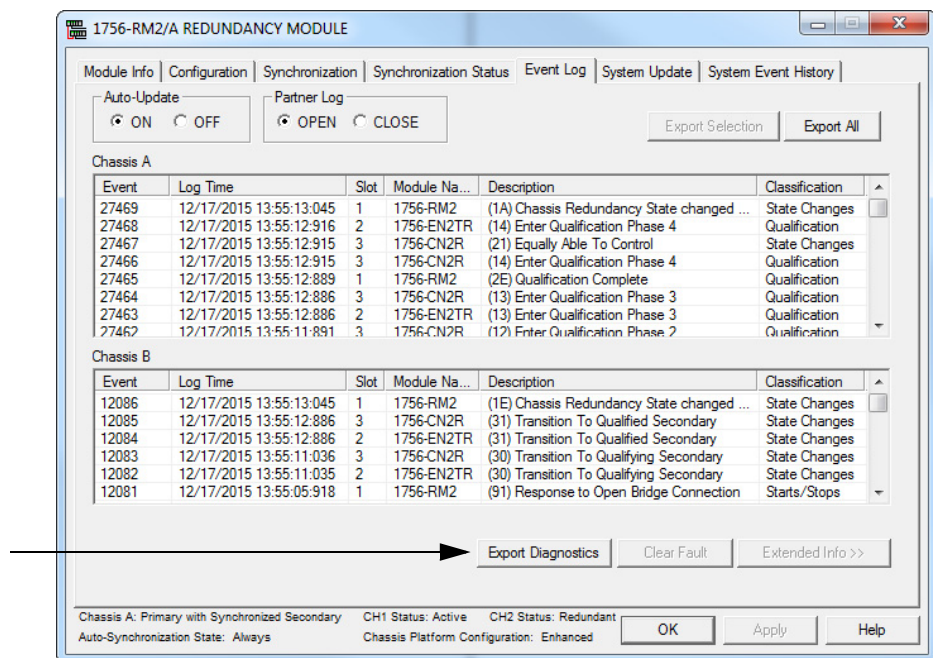

The Export Diagnostics dialog box appears and asks you to continue specifying a communication path.

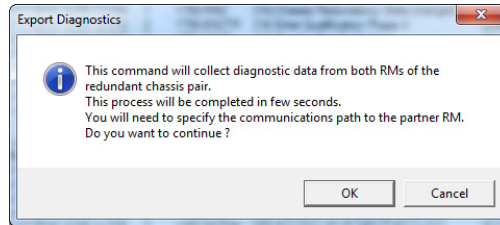

3. Click OK to specify the communication path via RSWho software.

The RSWho window appears.

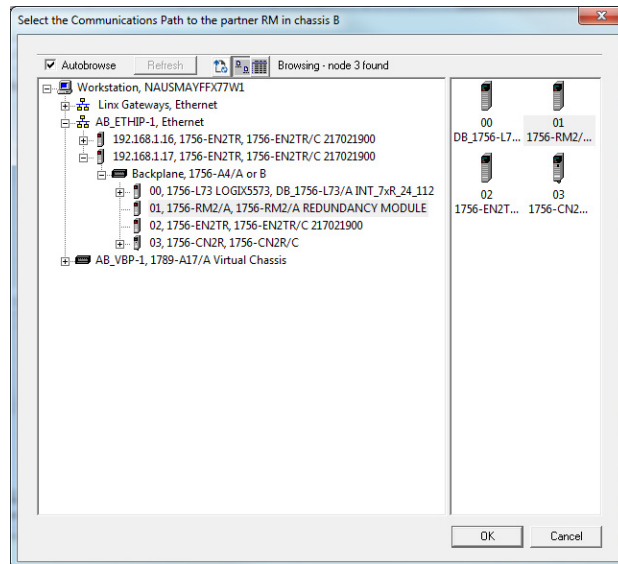

4. Select the communication path to the partner or secondary module and click OK.

The Export Diagnostics dialog box appears and prompts you to specify a location to save the export file.

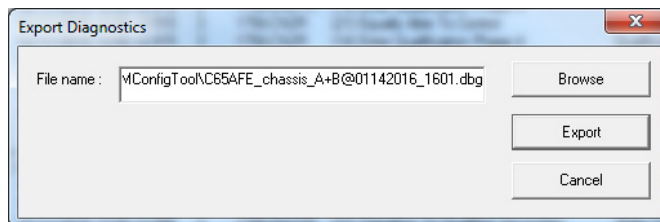

5. Name and save the export file.
6. Click Export.

It can take several minutes to export the data.

The Export Diagnostic Complete dialog box appears once the export has completed.

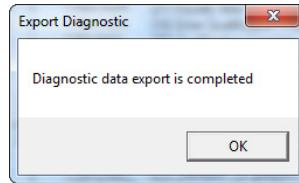

7. Click OK.

Forward this diagnostics file to Rockwell Automation Technical Support only if requested to do so.

Contact Rockwell Automation Technical Support

If you tried to use the event logs to troubleshoot your redundant system and are unsuccessful, prepare to contact Rockwell Automation Technical Support by exporting the event logs of **both** the primary and secondary redundancy modules. The technical support representative who assists you uses those files to help determine the cause of a switchover or other anomaly.

For more information about how to export the event logs, see [Export Event Log Data on page 178](#).

Controller Events

Occasionally, controller-related events can be logged in the RMCT Event Log. In some cases, the anomalies are strictly status updates and are not indicative of an anomaly that requires troubleshooting.

In other cases, the event description can indicate Program Fault Cleared, or a similar description of a resolved anomaly. If state changes or switchovers do not follow these types of events, then they are not indicative of an anomaly that requires additional troubleshooting.

If a state change or switchover follows an event that is logged for a controller in the redundant system, use the programming software to go online with the controller and determine the cause of the fault. For more information about how to use programming software to troubleshoot a fault, see the section titled [Use Programming Software to View Errors on page 171](#).

Keeper Status Causing Synchronize Failure

To determine if a keeper status anomaly is causing a synchronization failure, you can view the module status display of the ControlNet modules. You can also check the keeper status by using RSNetWorx for ControlNet software.

TIP To avoid anomalies with the Keeper Status, always reset the ControlNet module configuration of a module being used as a replacement **before** inserting and connecting the module in a ControlNet network.

For more information about how to reset the ControlNet module configuration, see [Automatic Keeper Crossloads on page 88](#).

Check the Module Status Display

If the module status display of the ControlNet modules in the redundant chassis indicates these errors, you must take corrective action:

- Keeper: Unconfigured
- Keeper: Unconfigured (data format changed)
- Keeper: Unconfigured (slot changed)
- Keeper: Unconfigured (net address changed)
- Keeper: Signature Mismatch
- Keeper: None Valid on Network

Check Keeper Status in RSNetWorx for ControlNet Software

To check the status of keepers on the ControlNet network, open RSNetWorx for ControlNet access the Keeper Status from the Network menu.

Figure 54 - Network Keeper Status

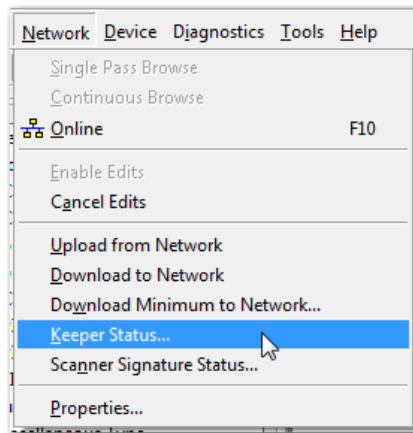

Valid Keepers and Signatures

This example shows a Keeper Status dialog box where the ControlNet network is composed of valid keepers and signatures.

Valid Keeper Status and Signatures

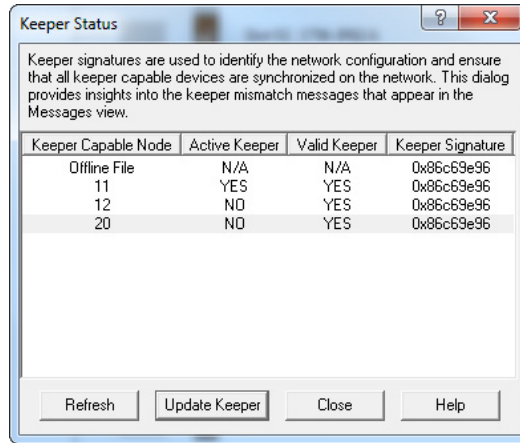

Unconfigured Keeper

The following example shows the Keeper Status dialog box where a module has an unconfigured status. Besides the status that is shown, the module status display indicates Keeper: Unconfigured (node address changed).

This error results when the node address of the module has been changed. After changing the node address, the module was used as a replacement and inserted into the redundant chassis.

Figure 55 - Keeper Status - Unconfigured

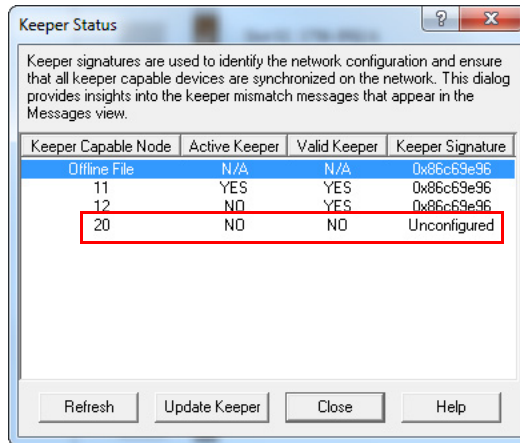

To correct this anomaly, do one of the following:

- Select the unconfigured module and click Update Keeper.
- Reschedule the ControlNet network.

Keeper Signature Mismatch

This example shows ControlNet modules in the redundant chassis that do not have the same keeper signatures. With this anomaly, the ControlNet module display indicates Keeper: Signature Mismatch.

This anomaly can result if a ControlNet module configured for the same node of another network is used to replace a ControlNet module with the same node address in the redundant chassis.

Figure 56 - Keeper Status - Signature Mismatch

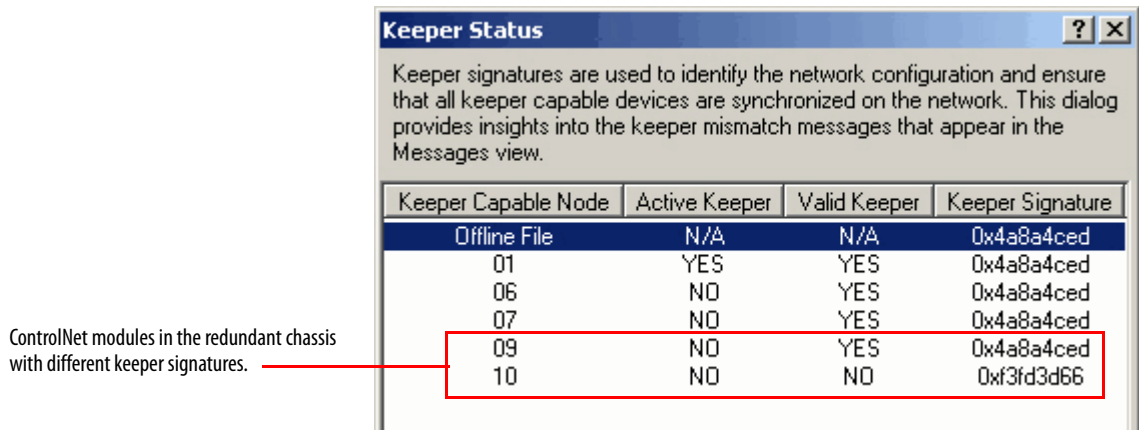

To **correct** this anomaly, do one of the following:

- Select the unconfigured module and click Update Keeper.
- Reschedule the ControlNet network.

Partner Network Connection Lost

If a partner network connection between a redundant chassis pair is lost, a state change or switchover can occur. These state changes can result:

- Primary with qualified secondary changes to primary with disqualified secondary
- Qualified secondary with primary to disqualified secondary with primary

To use the Event Log to determine if a lost partner network connection caused a state change, complete these steps.

IMPORTANT This example shows a connection that is lost over a ControlNet network. The same steps apply if the connection is lost over an EtherNet/IP™ network.

1. Open RSLinx Classic software and access the RMCT of the primary redundancy module.

This chassis is the chassis that was previously the secondary but is now the primary.

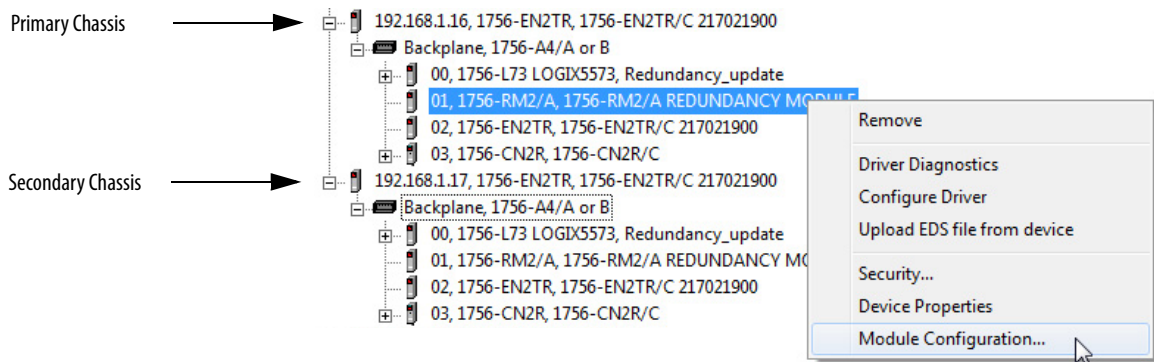

2. Locate the last event that indicates successful qualification and status.

Primary Chassis Event Log

A switchover is initiated.

Event indicates that chassis state is as a qualified secondary.

Chassis A						
Event	Log Time	Slot	Module Na...	Description	Classification	
23357	12/17/2015 04:37:22:407	1	1756-RM2	(C2) Bridge Connection Deleted	Starts/Stops	
23356	12/17/2015 04:37:22:407	1	1756-RM2	(C2) Bridge Connection Deleted	Starts/Stops	
23355	12/17/2015 04:37:22:407	1	1756-RM2	(C2) Bridge Connection Deleted	Starts/Stops	
23354	12/17/2015 04:37:22:403	1	1756-RM2	(BD) SYS_FAIL_L Active in Partner RM	Failure	
23353	12/17/2015 04:37:22:402	1	1756-RM2	(3D) Switchover Attempted	Switchover	
23352	12/17/2015 04:35:59:220	1	1756-RM2	(1E) Chassis Redundancy State changed ...	State Changes	
23351	12/17/2015 04:35:59:062	3	1756-CN2R	(31) Transition To Qualified Secondary	State Changes	
23350	12/17/2015 04:35:59:062	2	1756-FN2TR	(31) Transition To Qualified Secondary	State Changes	

3. Open the Event Log for the secondary chassis because the cause of the switchover is not apparent.
4. Use the time of the switchover event that is found in the primary chassis to identify the corresponding event in the secondary chassis.

The switchover indicated in the primary chassis log occurred at 04:37:22.

Secondary Chassis Event Log

Chassis B						
Event	Log Time	Slot	Module Na...	Description	Classification	
9326	12/17/2015 04:37:22:515	1	1756-RM2	(46) SYS_FAIL_L Inactive	Failure	
9325	12/17/2015 04:37:22:404	3	1756-CN2R	(1) Network Transition to Not Attached	Synchronizati...	
9324	12/17/2015 04:37:22:402	1	1756-RM2	(45) SYS_FAIL_L Active	Failure	
9323	12/17/2015 04:37:22:401	1	1756-RM2	(30) Switchover Attempted	Switchover	
9322	12/17/2015 04:37:22:401	2	1756-EN2TR	(1) Network Transition to Not Attached	Synchronizati...	
9321	12/17/2015 04:35:59:219	1	1756-RM2	(1A) Chassis Redundancy State changed ...	State Changes	

The corresponding events in the secondary chassis log indicate that the network is not attached and that the SYS_FAIL_LActive backplane signal is active. Both these events indicate an error in the connection of the ControlNet module to the network.

5. Confirm the ControlNet connection error by browsing the network in RSLinx Classic software.

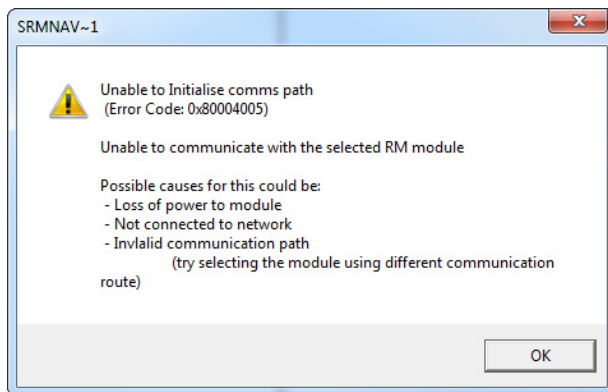
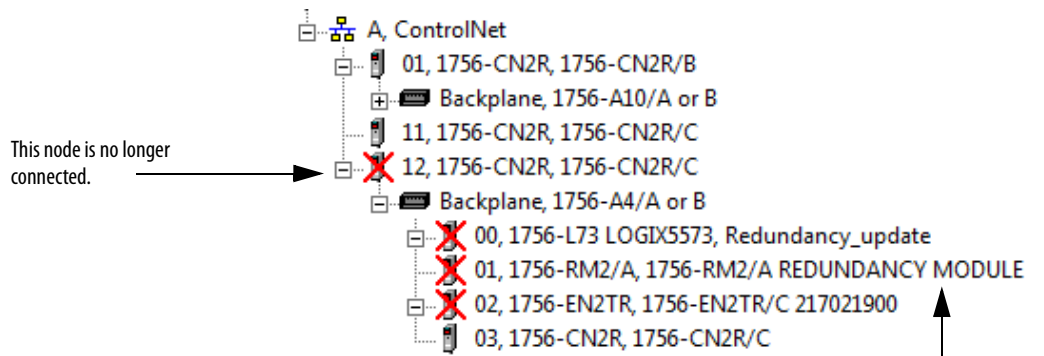

An attempt to access the secondary RMCT fails and this error is indicated.

To recover from a ControlNet network disconnection, perform the following:

- Check all ControlNet tap and trunkline connections. Correct any disconnections or other connection anomalies.
- If the Auto-Synchronization parameter is not set to Always, use the commands in the Synchronization tab of the RMCT to synchronize your chassis.

For more information about troubleshooting ControlNet network anomalies, see the ControlNet Network Configuration User Manual, publication [CNET-UM001](#).

To recover from an EtherNet/IP network disconnection, perform the following:

- Check all EtherNet/IP network and switch connections.
- If the Auto-Synchronization parameter is not set to Always, use the commands in the Synchronization tab of the RMCT to synchronize your chassis.

For more information about troubleshooting EtherNet/IP network anomalies, see the EtherNet/IP Network Configuration User Manual, publication [ENET-UM001](#).

Redundancy Module Connection Lost

To determine if the connection between the redundancy modules caused a switchover or state change, open the Event Log of the redundancy module that is the primary.

Chassis A					
Event	Log Time	Slot	Module Na...	Description	Classificati...
24076	12/17/2015 05:30:46:8...	3	1756-CN2R	(4) Partner Connection Timeout	Synchroniz...
24075	12/17/2015 05:30:46:7...	2	1756-EN2TR	(4) Partner Connection Timeout	Synchroniz...
24074	12/17/2015 05:30:46:1...	1	1756-RM2	(1C) Chassis Redundancy State changed to DSw...	State Char...
24073	12/17/2015 05:30:46:1...	1	1756-RM2	(56) The partner RM has been disconnected	State Char...
24072	12/17/2015 05:30:46:1...	1	1756-RM2	(C) Port2 Communication error	Minor Fault
24071	12/17/2015 05:30:46:1...	1	1756-RM2	(D0) CH2 Link Down	Minor Fault
24070	12/17/2015 05:30:46:1...	1	1756-RM2	(C) Port2 Communication error	Minor Fault

Chassis B					
Event	Log Time	Slot	Module Na...	Description	Classi...
9940	12/17/2015 05:31:43:901	1	1756-RM2	(1A) Chassis Redundancy State changed to PwQS	State
9939	12/17/2015 05:31:43:771	2	1756-EN2TR	(14) Enter Qualification Phase 4	Qualif
9938	12/17/2015 05:31:43:770	3	1756-CN2R	(21) Equally Able To Control	State
9937	12/17/2015 05:31:43:770	3	1756-CN2R	(14) Enter Qualification Phase 4	Qualif
9936	12/17/2015 05:31:43:742	1	1756-RM2	(2E) Qualification Complete	Qualif

The Event Log clearly indicates that one of the redundancy modules has been disconnected. In addition, the dimmed secondary chassis log indicates that the module is not connected.

To resolve this anomaly, check the intermodule cable that connects the redundancy modules. Verify that it is properly connected and is not severed.

Also, if the Auto-Synchronization parameter of this system is not set to always, use the commands in the Synchronization tab to synchronize that chassis once the anomaly is resolved.

Redundancy Module Missing

To determine if a missing redundancy module caused a state change and switchover, access the Event Log of the chassis that is the primary chassis.

Figure 57 - Event Log with Partner RM Screamed Event

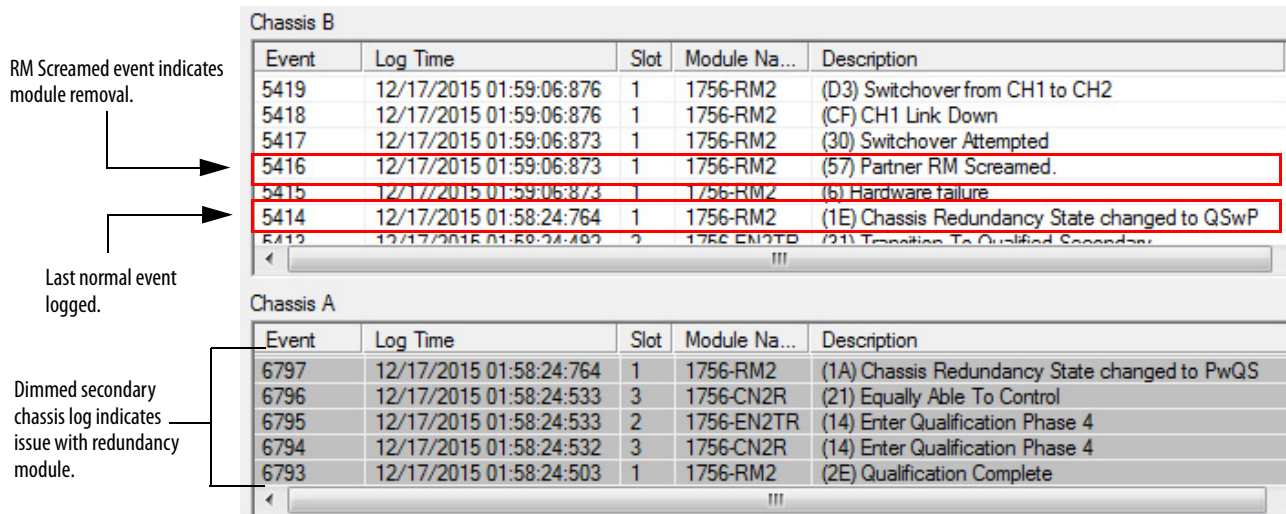

The redundancy module logs the Partner RM Screamed even just before it is disconnected. Depending on the cause of the missing module, the Partner RM Screamed event can fail to be logged before the module is lost.

You can also browse to the redundancy module in RSLinx Classic software to determine if it is connected to the network. A red X over the redundancy module indicates that the module is not in the chassis.

Figure 58 - Missing Redundancy Module in RSLinx Classic Software

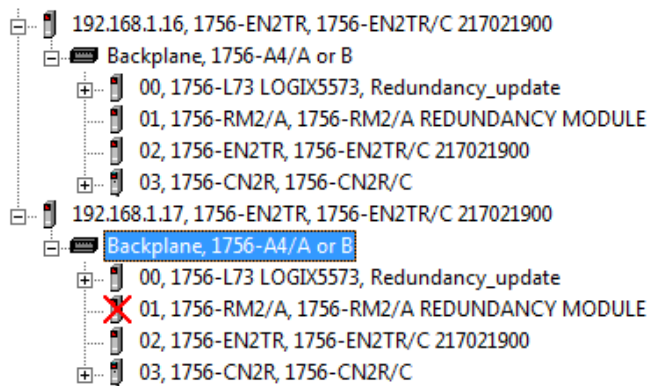

To correct the missing module anomaly, first verify that the redundancy module is correctly installed in the chassis and it is properly powered. Then check the intermodule cable that connects the redundancy modules.

After you have verified that the module is installed and powered, you can need to synchronize the chassis by using the synchronization commands in the Synchronization tab. Use the synchronization commands if your Auto-Synchronization parameter for the chassis is not set to Always.

Qualification Aborted Due to a Non-redundant Controller

If you place a controller that is not enabled for redundancy into the redundant chassis, the qualification and synchronization fail. To determine if your synchronization failure is due to a non-redundant controller, complete these steps.

1. If not already open, open the RMCT of the primary module.
2. Click the Synchronization tab and view the Recent Synchronization Status Attempts log.

The log indicates that there is a Module Configuration Error.

3. To view the description, select the aborted attempt.

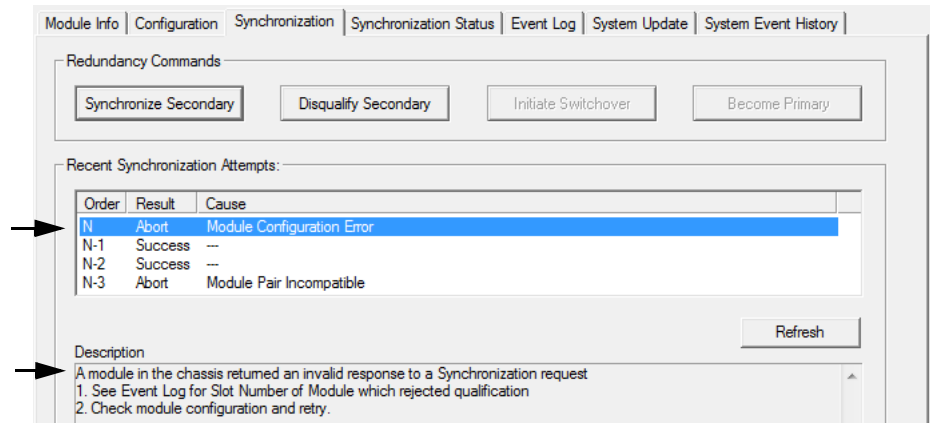

4. Click the Synchronization Status tab to check the compatibility between modules.

Slot	% Complete	Module Name	Module Revision	Secondary Readiness	State	Compatibility
0	0	DB_1756-L73/A INT_7xR...	24.50	Disqualified	Primary	Full
1	0	1756-RM2/A REDUNDAN...	20.5	Disqualified	Primary	Full
2	0	1756-EN2TR/C 217021900	10.7	Disqualified	Primary	Full
3	0	1756-CN2R/C	25.5	Disqualified	Primary	Full

All modules are indicated as being fully compatible.

5. Open the programming software and go online with the primary controller in your system.
6. Open the controller properties and verify that Redundancy Enabled is checked.

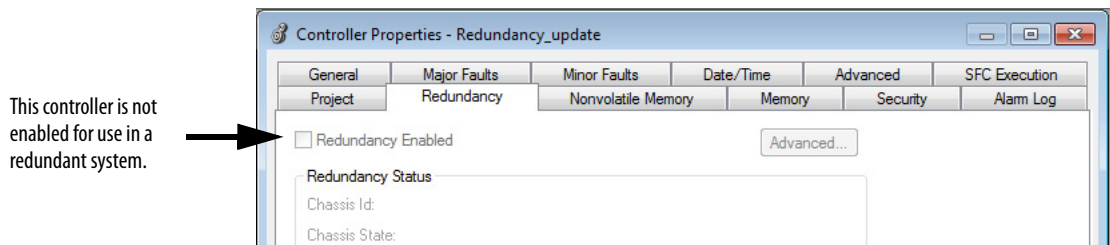

If Redundancy Enabled is **not** selected, then perform the following:

- Do one of the following:
 - Remove the controllers that are not Redundancy Enabled.
 - Enable the controller for redundancy and make other program changes to accommodate redundancy.
- After you remove or correct the Redundancy Enabled setting, attempt to synchronize your redundant system again.

Redundancy Module Status Indicators

The redundancy modules have these diagnostic status indicators.

1756-RM2/A and 1756-RM2XT Status Indicators

Figure 59 - Redundancy Module Status Indicators for 1756-RM2/A and 1756-RM2XT Modules

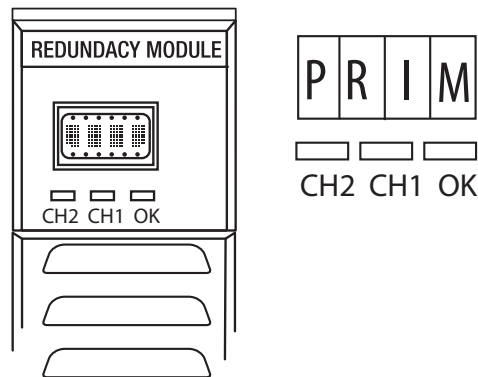

Module Status Display

The module status display provides diagnostic information.

Table 42 - Module Status Display

Module Status Display	Description
■■■■	Four-character display executing self-test at powerup. No action necessary.
Txxx	The redundancy module is executing a self-test at powerup. (xxx represents a hexadecimal test identification number.) Wait for self-test to finish. No action is required.
XFER	Application firmware update is in progress. Wait for firmware update to finish. No action is required.
ERAS	Boot mode - Erasing current redundancy module firmware
PROG	Flash b mode - Updating redundancy module firmware. Wait for firmware update to finish. No action is required.
????	Resolving initial redundancy module state. Wait for state resolution to finish. No action is required.
PRIM	Primary redundancy module. The module is operating as the primary module. No action is required.

Table 42 - Module Status Display

Module Status Display	Description
DISQ	Disqualified secondary redundancy module. Check the type and revision of the secondary partner module.
QFNG	Qualifying secondary redundancy module. Redundant system status. No action is required.
SYNC	Qualified secondary redundancy module. Redundant system status. No action is required.
LKNG	Secondary redundancy module that is in process of locking for update.
LOCK	Secondary redundancy module that is locked for update.
Exxx	Major fault has occurred (xxx represents an error or fault code, with the two least-significant characters in decimal). Use the Error ID code to diagnose and address the error. For more information on error codes, see Redundancy Module Fault Codes and Display Messages on page 213 .
EEPROM Update Required	Onboard EEPROM is empty. Replace the module.
BOOT Erase Error	Error in erasing NVS device while updating boot image. Cycle power to the module. If the error persists, replace the module.
BOOT Program Error	Error in writing in NVS device while updating boot image. Cycle power to the module. If the error persists, replace the module.
APP Erase Error	Error in erasing NVS device while updating application image. Cycle power to the redundancy module. If the error persists, replace the module.
APP Program Error	Error in writing in NVS device while updating application image. Cycle power to the redundancy module. If the error persists, replace the module.
CONFIG Erase Error	Error in erasing NVS device while updating configuration log image. Cycle power to the redundancy module. If the error persists, replace the module.
CONFIG Program Error	Error in writing in NVS device while updating configuration log image. Cycle power to the redundancy module. If the error persists, replace the module.
EEPROM Write Error	Error in writing in EEPROM device while updating configuration log image. Cycle power to the redundancy module. If the error persists, replace the module.
Application Update Required	The module is running boot firmware. Download the application firmware that is obtained from the respective redundancy bundle.
!CPT	A test line on the backplane is asserted. Check if the error message goes away after removing each module, one at a time. If error persists, cycle power to the chassis, or replace the chassis.
!Cpt	All modules in the chassis do not belong to the same redundancy platform.
Untrusted Certificate Error	The 1756-RM2/A and 1756-RM2XT modules use signed firmware. This error appears when either the contents of the downloaded certificate or its signature for the downloaded firmware is invalid.

OK Status Indicators

The OK status indicator reveals the current redundancy module state.

Table 43 - OK Status Indicator

Indicator State	Description
Off	No power is applied to the redundancy module. If necessary, apply power.
Solid red	One of these conditions exists: <ul style="list-style-type: none"> The redundancy module is conducting a self-test during powerup. No action necessary. The redundancy module has experienced a major shutdown fault. Cycle power to clear the fault. If the major fault does not clear, replace the module.
Flashing red	One of these conditions exists: <ul style="list-style-type: none"> The redundancy module is updating its firmware. No action necessary. The redundancy module has been configured improperly. Check the module configuration and correct any issues. The redundancy module has experienced a major fault that can be cleared remotely using the RMCT.
Solid green	The redundancy module is operating normally. No action is required.
Flashing green	The redundancy module is operating normally but is not communicating with the other redundancy modules in the same chassis. If necessary, establish communication with the other redundancy module.

CH1 and CH2 Status Indicators

The CH1 and CH2 status indicators reveal the following module states.

Table 44 - CH1 and CH2 Status Indicators

Indicator State	Description
Off	One of these conditions exists: <ul style="list-style-type: none"> No power RM major fault NVS update
Solid red	One of these conditions exists: <ul style="list-style-type: none"> No transceiver plugged in Faulted or failed transceiver detected Transceiver with incorrect or vendor ID detected
Intermittent red	For 1 s, then off, indicates powerup.
Flashing red	One of these conditions exists: <ul style="list-style-type: none"> Redundant channel error No cable connection
Intermittent green ⁽¹⁾	On for 256 ms for each packet that is received, then off. Active operating channel. (Channel that is used for data communication between the partner 1756-RM2/A modules.)
Flashing green ⁽¹⁾	Indicates that this channel is operating as the back-up channel and is ready to become the Active channel if the current Active channel fails.
Unknown	Operating state is not yet determined.
Active	Channel is operating normally as the active channel.
Redundant	Channel is operating normally as the redundant channel.

Table 44 - CH1 and CH2 Status Indicators

Indicator State	Description
Link Down	Channel is disconnected. Several causes could be: <ul style="list-style-type: none"> - The cable is disconnected, broken, or damaged - The signal is attenuated - The connector is loose - The partner 1756-RM2 module is powered down or in a major fault state
No SFP	No transceiver was detected. Several causes could be: <ul style="list-style-type: none"> - It has failed - It is loosely connected - It is not installed
SFP !Cpt	Rockwell Automation does not support the transceiver.
SFP Fail	The transceiver is in a failed state.

(1) Can be present for either CH1 or CH2, but not both simultaneously.

SFP Error Message

Use only Rockwell Automation approved small form pluggable (SFP).

When an incompatible SFP is installed in the 1756-RM2/A module, the CH1/CH2 status indicator shows solid red and the RMCT software displays the following error message in the status bar at the bottom of the screen: ‘SFP !Cpt.’

1756-RM/A and 1756-RM/B Status Indicators

Figure 60 - Redundancy Module Status Indicators for 1756-RM and 1756-RMXT Modules

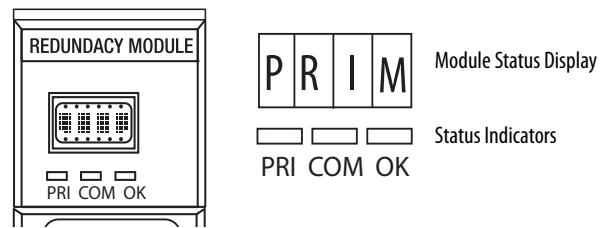

Module Status Display

The module status display provides diagnostic information.

Table 45 - Module Status Display

Module Status Display	Description
■■■■	Four-character display executing self-test at powerup. No action necessary.
Txxx	The redundancy module is executing a self-test at powerup. (xxx represents a hexadecimal test identification number.) Wait for self-test to finish. No action is required.
XFER	Application firmware update is in progress. Wait for firmware update to finish. No action is required.
ERAS	Boot mode - Erasing current redundancy module firmware.

Table 45 - Module Status Display

Module Status Display	Description
PROG	Boot mode - Updating redundancy module firmware. Wait for firmware update to finish. No action is required.
????	Resolving initial redundancy module state. Wait for state resolution to finish. No action is required.
PRIM	Primary redundancy module. The module is operating as the primary module. No action is required.
DISQ	Disqualified secondary redundancy module. Check the type and revision of the secondary partner module.
QFNG	Qualifying secondary redundancy module. Redundant system status. No action is required.
SYNC	Qualified secondary redundancy module. Redundant system status. No action is required.
LKNG	Secondary redundancy module that is in process of locking for update.
LOCK	Secondary redundancy module that is locked for update.
Exxx	Major fault has occurred (xxx represents an error or fault code, with the two least-significant characters in decimal). Use the Error ID code to diagnose and address the error. For more information on error codes, see Redundancy Module Fault Codes and Display Messages on page 213 .
EEPROM Update Required	Onboard EEPROM is empty. Replace the module.
BOOT Erase Error	Error in erasing NVS device while updating boot image. Cycle power to the module. If the error persists, replace the module.
BOOT Program Error	Error in writing in NVS device while updating boot image. Cycle power to the module. If the error persists, replace the module.
APP Erase Error	Error in erasing NVS device while updating application image. Cycle power to the redundancy module. If the error persists, replace the module.
APP Program Error	Error in writing in NVS device while updating application image. Cycle power to the redundancy module. If the error persists, replace the module.
CONFIG Erase Error	Error in erasing NVS device while updating configuration log image. Cycle power to the redundancy module. If the error persists, replace the module.
CONFIG Program Error	Error in writing in NVS device while updating configuration log image. Cycle power to the redundancy module. If the error persists, replace the module.
EEPROM Write Error	Error in writing in EEPROM device while updating configuration log image. Cycle power to the redundancy module. If the error persists, replace the module.
Application Update Required	The module is running boot firmware. Download the application firmware that is obtained from the respective redundancy bundle.
!CPT	A test line on the backplane is asserted. Check if the error message goes away after removing each module, one at a time. If error persists, cycle power to the chassis, or replace the chassis.
!Cpt	All modules in the chassis do not belong to the same redundancy platform.

OK Status Indicators

The OK status indicator reveals the current redundancy module state.

Table 46 - OK Status Indicator

Indicator State	Description
Off	No power is applied to the redundancy module. If necessary, apply power.
Solid red	One of these conditions exists: <ul style="list-style-type: none"> The redundancy module is conducting a self-test during powerup. No action necessary. The redundancy module has experienced a major fault. Cycle power to clear the fault. If the major fault does not clear, replace the module.
Flashing red	One of these conditions exists: <ul style="list-style-type: none"> The redundancy module is updating its firmware. No action necessary. The redundancy module has been configured improperly. Check the module configuration and correct any issues. The redundancy module has experienced a minor failure. Cycle power to clear the fault. If the major fault does not clear, replace the module.
Solid green	The redundancy module is operating normally. No action is required.
Flashing green	The redundancy module is operating normally but is not communicating with the other redundancy module. If necessary, establish communication with the other redundancy module.

Communication Status Indicator

The communication status indicator indicates activity on the redundancy module communication between chassis in the redundant chassis pair.

Table 47 - Communication Status Indicator

Indicator State	Description
Off	One of these conditions exist: <ul style="list-style-type: none"> No power is applied to the module. Apply power to the module. There is no communication between redundancy modules in the redundant chassis pair. Diagnose the redundancy configuration to determine why no communication is taking place.
Red < 1 second	The module has been started and has established partner communication. No action is required.
Solid red	The module has experienced a critical communication failure. Cycle power to clear the fault. If the major fault does not clear, replace the module.
Flashing green > 250 ms	Communication activity is present. No action is required.

Chassis State Status Indicator

The Chassis State (PRI) status indicator identifies whether the chassis is primary. The PRI status indicator on the primary redundancy module remains solid green, and the PRI status indicator on the secondary redundancy module remains off.

Redundancy Module Fault Codes and Display Messages

Redundancy modules can experience any of these faults.

Table 48 - Module Fault Codes

Fault Type	Description
Minor Recoverable	This fault type results in these conditions: <ul style="list-style-type: none"> The fault does not stop redundancy operations and provides you with a recovery mechanism. The module can clear some minor recoverable faults on its own.
Minor Nonrecoverable	This fault type results in these conditions: <ul style="list-style-type: none"> The fault does not stop redundancy operations. No recovery mechanism is available.
Major Recoverable	The fault impacts redundancy operations, although the effect is not always immediate. For example, if the fault occurred in the secondary redundancy module, the secondary chassis disqualifies and is not able to take over control if the primary redundancy module fails
Major Nonrecoverable	This fault type results in these conditions: <ul style="list-style-type: none"> This is a critical fault. Redundancy operations cease. A switchover can occur. No recover mechanism is available. The module can require replacement.

When the redundancy module experiences a fault, indication of that fault type is presented in these methods:

- Event log
- Module Status Display

IMPORTANT This section describes a **subset of module fault codes** you can see in the event log or Module Status Display.
If you see a fault code that is not included in this chapter, contact Rockwell Automation for assistance in troubleshooting that fault.

Event Log When Redundancy Module Experiences Fault

The redundancy module logs the fault type in its event log in NVS memory. You access the event log through the RMCT to troubleshoot the fault yourself or with assistance from Rockwell Automation Technical Support for troubleshooting the fault.

Module Status Display

A character string scrolls across the Module Status Display to indicate the fault type. The character string displays the fault type in either of these ways:

- Two to four-character word abbreviations
- Alpha numeric codes

This table describes the two to four-character word abbreviations.

Table 49 - Major Fault Code Messages

1st Word	2nd Word	3rd Word	4th Word	Error Description
CFG	LOG	ERR		Configuration log error. No action is required.
COMM	RSRC	ERR		Communication resource error. Reset the redundancy module.
COMM	RSRC	ERR	PRT1	Port1 Communication resource error on Backplane. Reset the redundancy module and check the chassis.
COMM	RSRC	ERR	PRT2	Port2 Communication resource error on redundancy link. Complete these tasks: 1. Reset the module. 2. Check the cable.
COMM	ERR	PRT1		Port1 Communication error, Backplane communication. Check or replace the chassis.
COMM	ERR	PRT2		Port2 Communication error on the redundancy link. Check or replace the single-mode cable.
COMM	ERR			General Communication Error. No action is required.
DUPL	RM			Duplicate redundancy module. This module is not in control. Remove this redundancy module.
EVNT	LOG	ERR		Event Log Error. No action is required.
FRMW	ERR			Firmware error. Update the firmware.
HDW	ERR			Hardware failure. Replace the module.
OS	ERR			Operating system error. Replace the module.
RM	PWR	DOWN		The redundancy module Power Down, Module detected a DC_Fail condition. Check the other modules in the chassis.
WDOG	ERR			Watchdog time out. Reset the module.
WDOG	FAIL			Watchdog task failed its status check. Replace the module.

The fault code is a four-character alphanumeric string. Valid characters are 0...9 and A through Z, except S and O. The first character is always E. Each firmware subsystem within the redundancy module is assigned a range of fault codes. Each subsystem assigns fault codes within its range.

If you encounter one of these error codes, record the Exxx code and contact Rockwell Automation Technical Support.

Recovery Messages

For certain faults, the module status display provides recovery instructions. Up to four, four-character words are displayed.

Table 50 - Recover Messages

Recovery Instruction Code	Description
RPLC MOD	Replace the module.
RSET MOD	Reset the module.
REMV MOD	Remove the module.
SEAT MOD	Reinsert the module into the chassis.

Convert from a Non-redundant System

Topic	Page
Update the Configuration in Programming Software	216
Replace Local I/O Tags	218
Replace Aliases to Local I/O Tags	219
Remove Other Modules from the Controller Chassis	220
Add an Identical Chassis	221
Upgrade to Redundancy Firmware	221
Update the Controller Revision and Download the Project	221

When converting from a non-redundant to a redundant system, first consider the following:

- You can use only Studio 5000 Logix Designer® versions 16, 19, 20, 24, 30, or 31 in a redundancy system.
- The redundant chassis pair has controller, communication module and I/O module restrictions.

See [Chapter 1, About ControlLogix Redundancy Systems](#) for additional information.

Complete the tasks in this section to convert a non-redundant ControlLogix® system to a redundancy system.

Update the Configuration in Programming Software

These steps provide an overview of the process that is required to update the I/O Configuration tree in the programming software.

1. If you have I/O in the chassis with the controller, add a ControlLogix communication module to the appropriate network because I/O modules are not permitted in a redundant chassis.

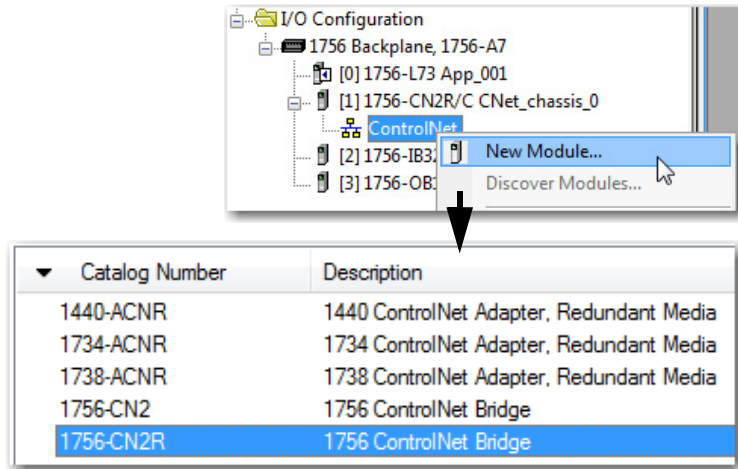

You can now move the I/O modules to the new chassis in the I/O Configuration tree.

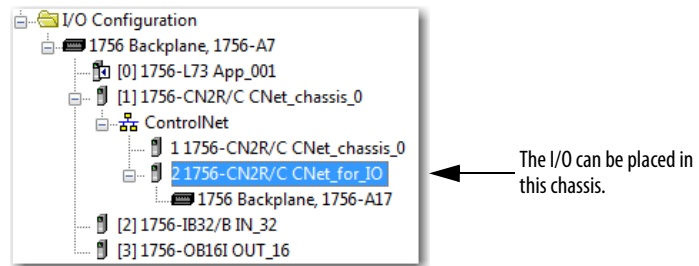

- Copy the I/O modules and paste them into the chassis of the newly added communication module.

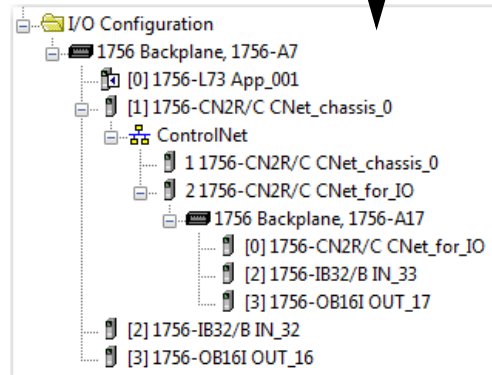
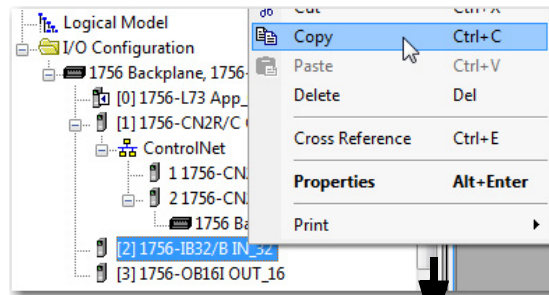

Paste I/O into the new ControlNet® chassis.

- Delete the I/O modules from the controller chassis configuration.

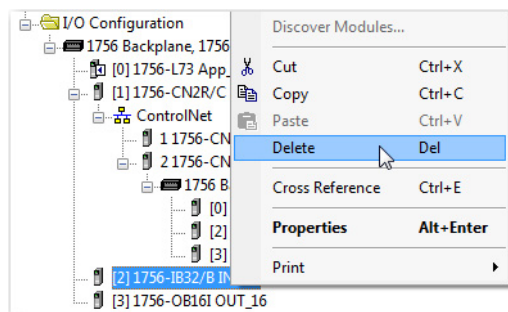

- Continue by completing the procedures to [Replace Local I/O Tags](#) and to [Replace Aliases to Local I/O Tags](#).

Replace Local I/O Tags

If you have moved I/O modules out of the local controller chassis and into the remote I/O chassis, complete these steps to find and replace the local I/O tags in your program.

1. Open the routine where the local I/O tags must be updated.
2. Press CTRL+H to open the Replace in Routines dialog box.

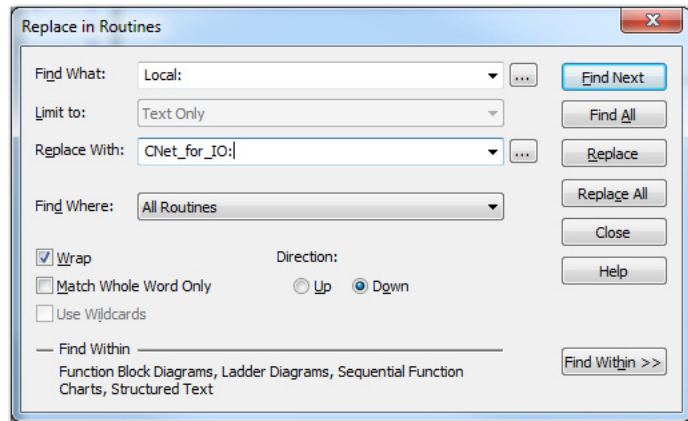

3. From the Find What pull-down menu, choose Local:.
4. From the Replace With pull-down menu, choose the name of the communication module where the remote I/O was placed.
5. From the Find Where pull-down menu, choose All Routines.
6. Click Find Within >>.
7. Select Ladder Diagrams.
8. Check Instruction Operands.

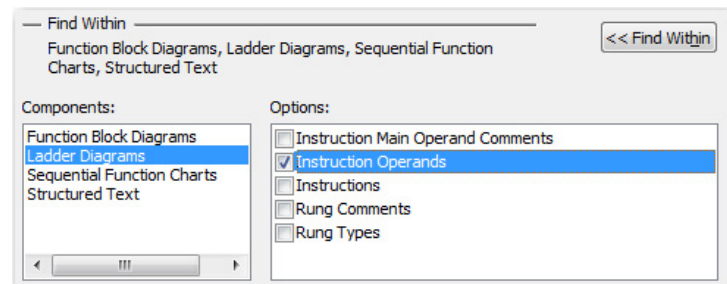

9. Click Replace All.

The find/replace is completed and the results are indicated in the Search Results tab.

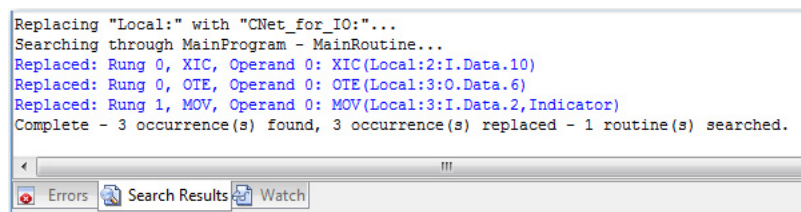

Replace Aliases to Local I/O Tags

If your program uses alias tags for the I/O modules that you are moving, complete these steps to replace alias tags.

1. In the programming software, open the Controller Tags.
2. Press CTRL+H to open the Replace Tags dialog box.

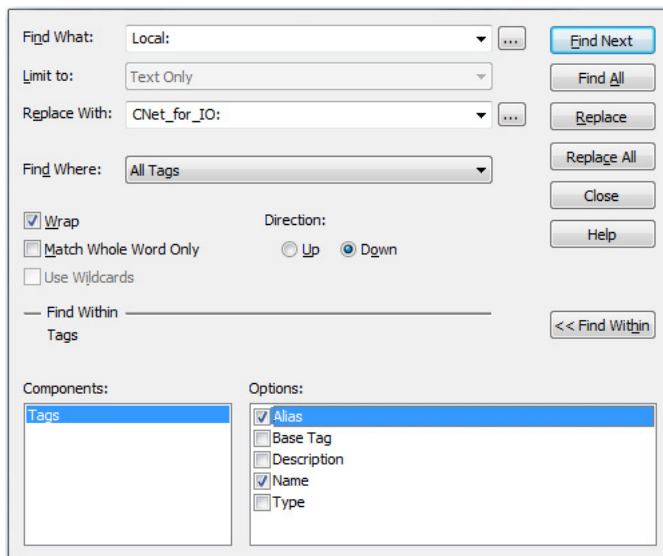

3. From the Find What pull-down menu, choose Local:.
4. From the Replace With pull-down menu, choose the name of the communication module where the remote I/O was placed.
5. From the Find Where pull-down menu, choose All Tags.
6. Click Find Within >>.
7. Select Alias and click Replace All.

The Search Results tab indicates the changed tags.

Remove Other Modules from the Controller Chassis

If modules other than those modules listed in [Table 51](#) are in the controller chassis, you must remove them. You can use these modules in ControlLogix redundancy systems. Not all components are compatible with all redundancy system revisions. To make sure of component compatibility, see the release notes specific to your redundancy system revision in the PCDC at: <http://www.rockwellautomation.com/global/support/pcdc.page>.

Table 51 - Components Available for Use in a Redundant Chassis Pair

Module Type	Cat. No.	Available with Redundancy System: Revision 31.05x_kit1	Available with Redundancy System: Revision 24.05x_kit1, Revision 30.05x_kit1	Available with Redundancy System: Revision 20.05x_kit1	Available with Redundancy System: Revision 19.053_kit2	Available with Redundancy System: Revision 16.081_kit4
Communication modules	1756-CN2 ⁽¹⁾	X	X	X	X	X
	1756-CN2R ⁽¹⁾	X	X	X	X	X
	1756-CN2RXT	X	X	X	X	X
	1756-EN2F	X	X	X	-	-
	1756-EN2T	X	X	X	X	X
	1756-EN2TR	X	X	X	X	-
	1756-EN2TP	X	-	-	-	-
	1756-EN2TXT	X	X	X	X	X
Controllers	1756-L61, 1756-L62, 1756-L63, 1756-L64	-	-	X	X	X
	1756-L63XT	-	-	X	X	X
	1756-L65	-	-	X	X	-
	1756-L71	X	X	X	-	-
	1756-L72, 1756-L73, 1756-L74, 1756-L75	X	X	X	X	-
	1756-L73XT	X	X	X	X	-
Redundancy modules	1756-RM	-	-	X	X	X
	1756-RMXT	-	-	X	X	X
	1756-RM2	X	X	X	X	X
	1756-RM2XT	X	X	X	X	X

(1) You can use series B or later modules.

Add an Identical Chassis

After you have configured your primary chassis with the modules that are listed in [Table 51](#), add an identical chassis that contains the same modules with the same module-placement.

For more information about chassis configuration, see the section titled [Redundant Chassis on page 21](#).

Upgrade to Redundancy Firmware

Once you have made the appropriate changes to your system configuration and program, and have added the identical chassis, upgrade your system firmware.

For information about how to upgrade the redundant system firmware, see [Update Redundant Firmware on page 58](#).

Update the Controller Revision and Download the Project

After you upgrade the firmware, use programming software to access the controller properties and update the controller revision to match the redundancy firmware revision you are using.

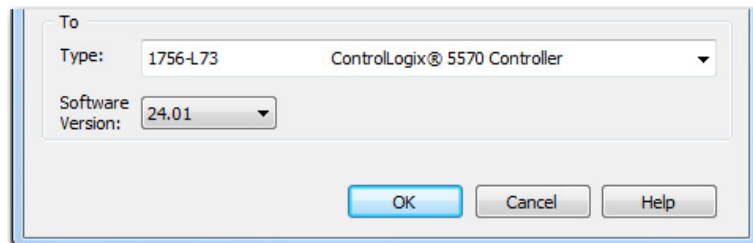

Once you have updated the controller firmware revision and saved the changes, download the updated program to the controller.

Notes:

Redundancy Object Attributes

Table of Redundancy Object Attributes

Use this table of redundancy object attributes as a reference when programming to obtain the status of your redundancy system.

For this information	Get this attribute	Data Type	GSV/SSV	Description	
				If	Then
Redundancy status of the entire chassis.	ChassisRedundancyState	INT	GSV		
				16#2	Primary with synchronized secondary
				16#3	Primary with disqualified secondary
				16#4	Primary with no secondary
				16#10	Primary locked for update
Redundancy state of the partner chassis.	PartnerChassisRedundancyState	INT	GSV		
				16#8	Synchronized secondary
				16#9	Disqualified secondary with primary
				16#E	No partner
				16#12	Secondary locked for update
Redundancy status of the controller.	ModuleRedundancy State	INT	GSV		
				16#2	Primary with synchronized secondary
				16#3	Primary with disqualified secondary
				16#4	Primary with no secondary
				16#6	Primary with synchronizing secondary
				16#F	Primary locking for update.
				16#10	Primary locked for update
Redundancy state of the partner.	PartnerModuleRedundancyState	INT	GSV		
				16#7	Synchronizing secondary
				16#8	Synchronized secondary
				16#9	Disqualified secondary with primary
				16#E	No partner
				16#11	Secondary locking for update
				16#12	Secondary locked for update
Results of the compatibility checks with the partner controller.	CompatibilityResults	INT	GSV		
				0	Undetermined
				1	No compatible partner
				2	Fully compatible partner

For this information	Get this attribute	Data Type	GSV/SSV	Description	
				If	Then
Status of the synchronization (qualification) process.	QualificationInProgress	INT	GSV		
				-1	Synchronization (qualification) is not in progress.
				0	Unsupported
				1...99	For modules that can measure their completion percentage, the percent of synchronization (qualification) that is complete.
				50	For modules that cannot measure their completion percentage, synchronization (qualification) is in progress.
				100	Synchronization (qualification) is complete.
Mode switch settings of the controller and its partner match or do not match.	Mode switchAlarm	DINT	GSV		
				0	<ul style="list-style-type: none"> • The mode switches match OR • No partner is present.
				1	Mode switches do not match
Position of the mode switchmode switch of the partner.	Partnermode switch	DINT	GSV		Then the mode switch is in
				0	Unknown
				1	RUN
				2	PROG
				3	REM
Status of the minor faults of the partner (if the ModuleRedundancyState indicates that a partner is present).	PartnerMinorFaults	DINT	GSV		Means this minor fault
				1	Power-up fault
				3	I/O fault
				4	Problem with an instruction (program)
				6	Periodic task overlap (watchdog)
				9	Problem with the serial port
				10	Low battery or issue with the energy storage module
Mode of the partner.	PartnerMode	DINT	GSV		
				16#0	Power up
				16#1	Program
				16#2	Run
				16#3	Test
				16#4	Faulted
				16#5	Run-to-program
				16#6	Test-to-program
				16#7	Program-to-run
				16#8	Test-to-run
				16#9	Run-to-test
				16#A	Program-to-test
				16#B	Into faulted
16#C	Faulted-to-program				

For this information	Get this attribute	Data Type	GSV/SSV	Description	
				If	Then
In a pair of redundant chassis, identification of a specific chassis without regard to the state of the chassis.	PhysicalChassisID	INT	GSV	0	Unknown
				1	Chassis A
				2	Chassis B
Slot number of the 1756-RM module in this chassis.	1756-RM SlotNumber	INT	GSV		
<ul style="list-style-type: none"> Size of the last crossload. Size of the last crossload if you had a secondary chassis. 	LastDataTransfer Size	DINT	GSV	<p>This attribute gives the size of data that was or would have been crossloaded in the last scan in the number of DINTs (4-byte words).</p> <p>The secondary chassis does not have to be connected or online. If you do not have a secondary chassis, the number of DINTs that would have been crossloaded are indicated.</p>	
<ul style="list-style-type: none"> Size of the biggest crossload. Size of the biggest crossload if you had a secondary chassis. 	MaxDataTransfer Size	DINT	GSV SSV	<p>This attribute gives the biggest size of the LastDataTransfer Size attribute in DINTs (4-byte words).</p> <p>The secondary chassis does not have to be connected or online. If you do not have a secondary chassis, the largest number of DINTs that would have been crossloaded are indicated.</p> <p>If you must reset this value, use an SSV instruction with a Source value of 0.</p>	

Notes:

Redundancy System Checklists

Topic	Page
Chassis Configuration Checklist	227
Remote I/O Checklist	228
Redundancy Module Checklist	228
ControlLogix Controller Checklist	229
ControlNet Checklist	230
EtherNet/IP Module Checklist	231
Project and Programming Checklist	232

Chassis Configuration Checklist

✓	Requirement
	Chassis that is used for the redundant pair are the same size, for example, both are 1756-A7, 7-slot chassis.
	Only these modules are used in the redundant chassis: <ul style="list-style-type: none"> • ControlLogix® controllers, catalog numbers 1756-L61, 1756-L62, 1756-L63, 1756-L63XT, 1756-L64, 1756-L65, 1756-L71, 1756-L72, 1756-L73, 1756-L73XT, 1756-L74, 1756-L75 <ul style="list-style-type: none"> – ControlLogix 5560 and ControlLogix-XT™ 5560 controllers are not compatible with redundancy systems that have firmware revision 24.50 or greater. • ControlNet® communication modules, catalog numbers 1756-CN2/B, 1756-CN2R/B, and 1756-CN2RXT • EtherNet/IP™ communication modules, catalog numbers 1756-EN2F, 1756-EN2T, 1756-EN2TP⁽¹⁾, 1756-EN2TR, and 1756-EN2TXT. • Redundancy modules, catalog numbers 1756-RM, 1756-RMXT, 1756-RM2/A, 1756-RM2XT
	Each chassis of the pair is composed of identical modules that are of identical redundancy firmware revisions and catalog numbers. ⁽²⁾
	Partner modules are placed in same slots of both chassis of the redundant pair (for example, the 1756-L63 is placed in slot 0 of both chassis).
	I/O modules are not placed in the redundant chassis.
	Seven or fewer communication modules of any type or combination are used in each redundant chassis.

(1) You can use the 1756-EN2TP module only with a redundancy system, revision 31.052 or later.

(2) There are some exceptions to this requirement. For more information, see [Redundant Chassis on page 21](#).

Remote I/O Checklist

✓	Requirement
	I/O is not placed in redundant chassis.
	<p>I/O is connected to the redundant chassis by using one of these networking options:</p> <ul style="list-style-type: none"> • ControlNet connections to the same ControlNet network as the redundant controller chassis, without bridging. • EtherNet/IP connections to the same EtherNet/IP network as the redundant controller chassis, without bridging. If in the I/O tree of the redundancy controller, all I/O and consumed tag connections must be multicast connections. The I/O tree of the redundancy controller can contain produced unicast tags that remote devices consume. • A DeviceNet® network that is connected through a 1756-DNB DeviceNet communication module in a remote, that is, non-redundant, chassis. • A universal remote I/O or Data Highway Plus™ network that is connected by using a 1756-DHRIO module in a remote (non-redundant) chassis.

Redundancy Module Checklist

✓	Requirement
	One redundancy module is placed in the same slot of each redundant chassis.
	<p>Series A and B redundancy modules are fully compatible. Therefore, you can use any combination of them in a partnered set, for example, a 1756-RM/A module in the primary chassis and a 1756-RM/B module in the secondary chassis. However, the best scan performance occurs when two Series B redundancy modules are used with ControlLogix 5570 controllers.</p> <hr/> <p>IMPORTANT The scan time is slightly extended when you downgrade a Series B redundancy module to a Series A module with a ControlLogix 5570 controller in the redundant chassis pair. In this case, raise the task watchdog limits by a factor of ~2x before downgrading. Thereafter, you can retune the limits that are based on the updated scan time numbers.</p> <p>ControlLogix 5560 controllers that are used with a combination of Series A and Series B redundancy modules in the redundant chassis pair have the same performance as if only Series A redundancy modules are used in the redundancy chassis pair. This result is regardless of the primary or secondary redundancy state.</p> <hr/>
	<p>A fiber-optic cable connects the redundancy modules in the redundant chassis pair. The following are catalog numbers of fiber-optic cable you can order from Rockwell Automation:</p> <ul style="list-style-type: none"> • 1756-RMC1 (1 m, 3.28 ft) • 1756-RMC3 (3 m, 9.84 ft) • 1756-RMC10 (10 m, 32.81 ft) <p>If necessary, you can make your own fiber-optic cable that is up to 4 km (13,123.36 ft) for the 1756-RM/B module or 10 km (32,808.40 ft) for the 1756-RM2 module.</p>

ControlLogix Controller Checklist

✓	Requirement
	Identical ControlLogix controllers are placed in the same slot of both chassis of the redundant pair.
	Partnered controllers are identical in redundancy firmware revision.
	<p>Within each redundant chassis, one or two (maximum) of these controllers⁽¹⁾ are used:</p> <ul style="list-style-type: none"> • 1756-L61, 1756-L62, 1756-L63, 1756-L63XT, 1756-L64⁽²⁾, 1756-L65 • 1756-L71, 1756-L72, 1756-L73, 1756-L73XT, 1756-L74, 1756-L75 <p>Do not combine ControlLogix 5560 and ControlLogix 5570 controllers in a redundant chassis. ControlLogix 5560 and ControlLogix-XT 5560 controllers are not compatible with redundancy systems that have firmware revision 24.052_kit1 or later.</p>
	<p>Each controller in the redundancy chassis has enough memory to store twice the amount of controller data and I/O memory. See Knowledgebase ID 28972, accessible at: https://rockwellautomation.custhelp.com/ A login is required to access the article.</p>
	Eight controller connections are reserved for redundancy use.

(1) The controllers can be of any series as long as the firmware revisions and catalog numbers are identical.

(2) When using ControlLogix redundancy system, revision 16.081 or earlier, you cannot use two 1756-L64 controllers in the same chassis. You can, however, use a 1756-L64 controller in the same chassis as a 1756-L61, 1756-L62, or 1756-L63 controller.

ControlNet Checklist

✓	Requirement
ControlNet Module	
	Identical ControlNet modules are placed in the same slot of both chassis of the redundant pair.
	ControlNet modules are identical in redundancy firmware revision and in catalog number.
	Only the 1756-CN2/B, 1756-CN2R/B, or 1756-CN2RXT ControlNet modules are used.
	Partnered ControlNet modules both have identical keeper information as explained in the ControlNet Network Configuration User Manual, publication CNET-UM001 .
	Three connections of the ControlNet module are appropriately reserved for redundancy system use.
ControlNet Network	
	USB ports of communication modules in the redundant chassis are not used while the system is running (online).
	At least four ControlNet nodes are used on the ControlNet network. That is, at least two ControlNet nodes are on the ControlNet network along with the two ControlNet modules in the redundant chassis.
	<p>These requirements apply to at least one ControlNet node:</p> <ul style="list-style-type: none"> • It is not in the redundant chassis pair. • It uses a node address lower than the ControlNet node addresses of modules in redundant chassis pair. <p>These requirements apply to all ControlNet communication modules available in a redundancy system.</p>
	<p>ControlNet module partners in the redundant chassis have the following:</p> <ul style="list-style-type: none"> • Node address switches set to the same address (for example, the switches of both modules are set to node address 13). • Two consecutive node addresses reserved (for example, nodes 13 and 14) to accommodate a switchover. The primary ControlNet module can have an even or odd-numbered node address.
	The ControlNet network is scheduled by using techniques that are described in the ControlNet Network Configuration User Manual, publication CNET-UM001 . ⁽¹⁾
	Devices on other communication networks are bridged to the ControlNet network appropriately.
ControlNet HMI	
	A ControlNet network or a ControlNet-to-EtherNet/IP gateway is used to connect to HMI because your system requires that HMI be updated immediately after a switchover.
	<ul style="list-style-type: none"> • PanelView™ Standard terminal, PanelView 1000e, or 1400e terminal For an unscheduled network, ≤ 4 HMI terminals per controller are used. For a scheduled network, any number of terminals within the limits of the ControlNet network are used. • PanelView Plus terminal, VersaView® industrial computer that runs a Windows CE operating system RSLinx® Enterprise software, version 5.0 or later, is used. Within each controller and communication module, five connections for each PanelView Plus or VersaView terminal are reserved. • FactoryTalk® View SE software with RSLinx communication software, version 2.52 or later, RSView®32 software, FactoryTalk Linx software, version 5.0 The number of RSLinx servers that a controller uses is limited to 1 . . . 4 (maximum).

(1) Unscheduled ControlNet networks can be used, however, certain use considerations must be made. See [Chapter 5, Configure the ControlNet Network on page 77](#).

EtherNet/IP Module Checklist

✓	Requirement
EtherNet/IP Module	
	Identical EtherNet/IP communication modules are placed in the same slot of both chassis of the redundant chassis pair.
	EtherNet/IP communication modules are one of these catalog numbers: <ul style="list-style-type: none"> • 1756-EN2F, 1756-EN2T, 1756-EN2TP⁽¹⁾, 1756-EN2TR, and 1756-EN2TXT
EtherNet/IP Network	
	With firmware revision 19.052 and later, you can use an EtherNet/IP network for I/O and produced/consumed tags. With firmware revisions 16.081 and earlier, an EtherNet/IP network does not support I/O or produced/consumed tags.
	Redundancy systems support unicast produced tags. Unicast consumed tags are not supported in redundancy systems.
	USB ports of communication modules in the redundant chassis are not used while the system is running (online).
	IP addresses of devices on the EtherNet/IP network are static and IP address swapping is enabled. ⁽²⁾
EtherNet/IP HMI	
	HMI Blind Time is the time during a switchover from primary to secondary, when tag data from the controller is unavailable for reading or writing. See HMI Blind Time Reduction During a Switchover on page 17 . IMPORTANT: This feature requires FactoryTalk Linx software, version 5.50.04 or later.
	<ul style="list-style-type: none"> • PanelView Standard terminal None (the use of the PanelView Standard terminal in a redundant system requires the same considerations as a non-redundant system). • PanelView Plus terminal, VersaView industrial computer that runs a Windows CE operating system FactoryTalk Linx software, version 3.0 or later, is used. Within each of the controllers and communication modules, five connections for each PanelView Plus or VersaView terminal are reserved. • FactoryTalk® View SE software with FactoryTalk Linx software FactoryTalk Linx software, version 3.0 or later is used. IP address swapping is used. HMI and both redundant chassis are on the same subnet. • FactoryTalk View SE software with RSLinx software, version 2.x, RSView32 software, Any other HMI client software that uses RSLinx software, version 2.x The number of RSLinx servers that a controller uses is limited to 1 . . . 4 (maximum).

(1) You can use the 1756-EN2TP module only with a redundancy system, revision 31.052 or later.

(2) Other IP address configurations are permitted, but require additional considerations. For more information, see [IP Address Swapping on page 66](#).

Project and Programming Checklist

Also see the [ControlLogix Controller Checklist](#) on page 229.

✓	Requirement								
	The Redundancy Module Date and Time has been set by using the RMCT.								
	One project is created by using programming software and is downloaded to the primary controller. ⁽¹⁾								
	Redundancy is enabled within the Redundancy tab of the Controller Properties dialog box. Time synchronization is enabled within the Date/Time tab of the Controller Properties dialog box. Time Sync and Motion is selected in the Module Definition dialog box for the Ethernet module that is located in the local chassis.								
	Task configuration is either: <ul style="list-style-type: none"> • One continuous task within the project. or <ul style="list-style-type: none"> • Multiple periodic tasks with only one task at the highest priority. Also, multiple tasks are structured at all different priorities and periods so that the fewest possible separate tasks are used. 								
	The redundant controller program does not contain: <ul style="list-style-type: none"> • Event tasks. • Inhibited tasks. 								
	Programming specific to critical I/O that must be bumpless is placed in the highest-priority user task according to your task configuration. <table border="1" style="width: 100%; margin-top: 10px;"> <thead> <tr> <th style="text-align: center;">If you use this task structure</th> <th style="text-align: center;">Then programming specific to bumpless I/O is in</th> </tr> </thead> <tbody> <tr> <td>One continuous task</td> <td>The continuous task.</td> </tr> <tr> <td>One continuous task and one or more periodic tasks</td> <td>The highest-priority periodic task where only that one task is at the highest priority.</td> </tr> <tr> <td>Multiple periodic tasks</td> <td>The highest-priority periodic task where only that one task is at the highest priority.</td> </tr> </tbody> </table>	If you use this task structure	Then programming specific to bumpless I/O is in	One continuous task	The continuous task.	One continuous task and one or more periodic tasks	The highest-priority periodic task where only that one task is at the highest priority.	Multiple periodic tasks	The highest-priority periodic task where only that one task is at the highest priority.
If you use this task structure	Then programming specific to bumpless I/O is in								
One continuous task	The continuous task.								
One continuous task and one or more periodic tasks	The highest-priority periodic task where only that one task is at the highest priority.								
Multiple periodic tasks	The highest-priority periodic task where only that one task is at the highest priority.								
	For ControlLogix 5560 controllers, the task watchdog is $(2 * \text{maximum_scan_time}) + 150$ ms when using ControlNet I/O and $(2 * \text{maximum_scan_time}) + 100$ ms when using Ethernet I/O, where maximum_scan_time is the maximum scan time for the entire task to complete when the redundant controllers are synchronized. To calculate watchdog time for ControlLogix 5570 controllers, see Minimum Value for the Watchdog Time on page 145 .								
	Scan time is minimized by using these techniques when possible: <ul style="list-style-type: none"> • Unused tags are eliminated. • Arrays and user-defined data types are used instead of individual tags. • Redundancy data is synchronized at strategic points by using the Synchronize Data after Execution setting in the Program Properties dialog box. • Programming is written as compactly and efficiently as possible. • Programs are executed only when necessary. • Data is grouped according to frequency of use. • DINT tags are used instead of SINT or INT tags. 								
	For produced/consumed data, the communication module in the remote chassis that holds the consuming controller uses the Comm Format: None.								
	Critical messages from a remote chassis to redundant chassis use cached connections.								
	Active tags on scan per controller are less than 10,000 tags/second.								

(1) The project that is loaded on the primary controller is automatically crossloaded to the secondary controller when synchronization occurs.

Numerics

- 1715 Redundant I/O systems** 12, 14, 36
- 1756-CN2x modules** 25
- 1756-EN2T**
 - sockets 73
- 1756-EN2TR**
 - sockets 73
- 1756-EN2Tx modules** 25
- 1756-RM**
 - status indicators 170
- 1756-RM and 1756-RMXT modules** 24
- 1756-RM2/A** 46, 50
 - ControlLogix 5570 120
 - crossload 119
 - dual fiber ports 57
 - status indicators 170, 207
- 1756-RM2XT/A** 46, 50
 - status indicators 207

A

- Array (File)/Shift instructions** 127
- Auto-Synchronization** 97

B

- BOOTP/DHCP utility** 74

C

- calculate**
 - task watchdog 145
- CH1**
 - status indicators 209
- CH2**
 - status indicators 209
- chassis** 44
 - designate 61
 - ID 98
 - install 45
 - module placement 45
 - primary 15
 - secondary 15
- chassis configuration list** 227
- CIP Sync technology** 12, 69 – 71
- clearing a fault** 183
- communication**
 - EtherNet/IP delay 28
 - module connections 26
 - modules 25
- communication module** 44
 - unicast 18
- components**
 - overview 13
- concise, program** 125

configuration

- controller 109
- EtherNet/IP modules 73
- HMI 38
- remote I/O 36
- RMCT
 - determine if needed 90

Configuration tab

connections

- communication 26
- controller 23

continuous task

- execution 114
- recommended 114

ControlFLASH

- 44, 59

controller

- configure redundancy 109
- connections 23
- enable user program 98
- event in Event Log 207
- save project 88
- status 171
- troubleshoot
 - non-redundant 206
- use multiple 120

controller logging

ControlLogix 5560

ControlLogix 5570

- 1756-RM2/A 120
- memory usage slider 155

ControlNet

- CPU usage 167
- keeper crossload 88
- keeper status 86
- module
 - check status 166
 - monitor CPU usage 167
 - network update time 79
 - node requirements 30 – 32
 - overview 30 – 33
 - produce/consume connections 77
 - redundant media 33
 - remote I/O 14
 - requirements 30 – 33
 - sample programs 165, 167
 - schedule
 - existing network 85
 - new network 82
 - troubleshoot
 - keeper status 199
 - lost connection 202
 - unscheduled 81

conversion

- non-redundant to redundant 62

convert

- nonredundant to redundant 215 – 221

CPU usage

- Ethernet/IP 65

crossload 46
 1756-RM2/A 119
 ControlNet keepers 88
 default 114
 estimate 118
 redundancy object attributes 118
 redundant system 15
 scan time 118

D

Data Highway Plus 35
date and time 98
designate
 primary chassis 61
designation
 chassis 61
 conduct 15
 qualification after 62
DeviceNet 35
DSwNP
 qualification status indicators 193
DSwP
 qualification status indicators 193
dual fiber ports
 1756-RM2/A 57
duplex setting 74

E

electrostatic discharge 47
enable
 user program control 98
environmental considerations 43
Ethernet
 HMI blind time 17
EtherNet/IP
 1715 Redundant I/O systems 12
 configure module 73
 delay 28
 duplex setting 74
 IP address swapping 66 – 68
 overview 34
 produce/consume connections 72
 remote I/O 12, 14
 requested packet interval 65
 requirements 34
 set address 74
 troubleshoot
 lost connection 202
 use of CIP Sync technology 69 – 71
 with HMI 38
Ethernet/IP
 CPU usage 65
Event Log
 controller event 207
 qualification events 63
 RMCT 190

Event Log tab 174 – 183
 clearing a fault 183
 export data for all events 181 – 182
 export single event data 178 – 180
 extended event information 177
execution
 continuous task 114
 periodic task 116
export data for a single event 178 – 180
export data for all events 181 – 182
export diagnostics button 196
export event log 178 – 182
extended event information 177

F

FactoryTalk software 12
fiber-optic cable 56
 redundancy channels 54
fiber-optic communication cable 44
firmware 58
 revision 41
 signed and unsigned 13
 update 58 – 61
firmware bundle 43
flash upgrade 58

H

hardware
 install 45
HMI blind time
 Ethernet 17
Human-Machine-Interface (HMI) 38 – 40
 use over ControlNet 39
 use over EtherNet/IP 38

I

I/O
 1715 Redundant I/O systems 12, 36
 in redundancy system revisions 14
 multicast 228
 over EtherNet/IP network 12
 placement 14, 36
install
 hardware 44, 45
 power supply 45
 primary chassis 45 – 52
 redundancy module 46
 secondary chassis 52
installation instructions 51

IP address

- BOOTP/DHCP utility 74
- consecutive 66
- plan 73
- programming software 74
- RSLinx communication software 74
- set 74
- swap 66
- swapping 66 - 68
- switches 74

K**keeper**

- crossloads 88
- status 86
 - mismatch 201
 - module status display 199
 - RSNetWorx for ControlNet software 199
 - unconfigured 200
 - valid 200
- troubleshoot 199

L**laser radiation ports 50****log**

- Recent Synchronization Attempts 100

logic, scan-dependent 128**M****memory usage slider**

- ControlLogix 5570 155

mode switch

- REM 59

Module Info tab 94 - 95**module placement**

- chassis 45

module status display 162**monitor**

- ControlNet
 - sample programs 165, 167

motion

- unsupported feature 13

MSG instruction 141**multicast**

- I/O 228

N**network 81**

- ControlNet
 - monitor CPU usage 167
 - overview 30 - 33
- Data Highway Plus 35
- DeviceNet 34, 35
- EtherNet/IP 34

- overview 28 - 29

- keeper 86

- keeper crossload 88

- Remote I/O 34

- schedule

- existing 85

- new 82

- Universal Remote I/O 35

- update time 79

network update time 79**non-redundant controller 206****non-redundant to redundant**

- conversion 62

nonredundant, convert from 215 - 221**O****online edits 149 - 155**

- finalize 152

- reserve memory 155

- retain edits 151

- test edits 150

operations

- chassis designation 15

- crossload 15

- qualification 15

- redundancy system 15

- switchover 15

- synchronization 15

optical ports 48**P****parallel redundancy protocol 76****Partial Import Online 149****periodic task 135**

- execution 116

- recommended 114

power supply 27, 44

- install 45

primary chassis 15

- designate 61

- designation 61 - 63

- installation 45 - 52

produce/consume connections

- over ControlNet 77

- over EtherNet/IP 72

produced tags

- unicast 73

program

- crossload

- default 114

- scan time 118
 - enable user control 98
 - finalize test edits 152
 - logic after switchover 138
 - maintain data integrity 127 - 130
 - manage tags 122
 - messages for redundancy commands 139 - 143
 - monitor system status 159
 - online edits 149 - 155
 - optimize task execution 131 - 136
 - Partial Import Online 149
 - periodic task 135
 - reserve memory 155
 - scan time
 - minimize 120 - 126
 - synchronization
 - default 114
 - system overhead time slice 132
 - tags 122
 - task type 114
 - test edits 150
 - use concise 125
 - programming software** 74
 - project**
 - save 88
 - PsDS**
 - qualification status indicators 193
 - PwNS**
 - qualification status indicators 193
 - PwQS**
 - qualification status indicators 193
- Q**
- QSwP**
 - qualification status indicators 193
 - qualification**
 - after designation 62
 - check in RMCT 164
 - check status 162
 - description of 15
 - status via RMCT 63
 - troubleshoot
 - non-redundant controller 206
 - qualification status indicators** 193
 - DSwNP 193
 - DSwP 193
 - PwDS 193
 - PwNS 193
 - PwQS 193
 - QSwP 193
 - qualify**
 - redundant module 63
 - quick start**
 - redundancy system 43
- R**
- Recent Synchronization Attempts log** 100
 - redundancy channels**
 - fiber-optic cable 54
 - redundancy module** 24, 44
 - date and time 98
 - info 94 - 95
 - install 46
 - lost connection between modules 204
 - troubleshoot
 - missing 205
 - Redundancy Module Configuration Tab**
 - qualification
 - status 63
 - Redundancy Module Configuration Tool** 89
 - additional configuration 90
 - check qualification 164
 - Configuration tab 96 - 98
 - Event Log tab 174 - 183
 - identify version 92
 - Module Info tab 94 - 95
 - open 91
 - Synchronization Status tab 102
 - Synchronization tab 99 - 102
 - System Update tab 103 - 108
 - update 93
 - redundancy object attributes**
 - for crossload time 118
 - redundancy system**
 - chassis 21
 - communication modules 25
 - components 13
 - controllers 22
 - features 12
 - operations 15
 - power supply 27
 - quick start 43
 - redundancy modules 24
 - restrictions 18
 - using ControlNet 30 - 33
 - using EtherNet/IP 28 - 29
 - redundant chassis**
 - designate 61
 - example 19, 21
 - redundant fiber cable** 53
 - redundant fiber ports**
 - single point of failure 12
 - redundant media**
 - ControlNet 33
 - redundant module**
 - qualify 63
 - remove 64
 - replace 64
 - reset 63
 - REM**
 - mode switch 59
 - remote**
 - 1715 Redundant I/O systems 36
 - communication modules 35
 - I/O 12
 - ControlNet 14
 - EtherNet/IP 14
 - placement 36
 - remote controller**
 - unicast 72
 - remove**
 - redundant module 64

replace
 redundant module 64

requested packet interval
 over EtherNet/IP 65

requirements
 ControlNet 30 - 33
 EtherNet/IP 34
 firmware 41

reset
 redundant module 63

restrictions 18
 redundancy system 18

RIUP 47

RMCT 43, 89
 Event Log 190
 troubleshoot 190
 version 92

RSLinx Classic 43

RSLinx communication software 74

S

scan time
 best performance 120
 concise programming 125
 crossload 118
 efficient crossloads 122 - 124
 minimize 120 - 126
 multiple controllers 120
 number of programs 121

scan-dependent logic 128

schedule
 ControlNet 82

secondary chassis 15
 designation 61 - 63
 installation 52

set IP address 74

SFP 210
 small form pluggable 56
 transceiver 56

signed and unsigned
 firmware 13

SIL3
 unsupported feature 13

single point of failure
 redundant fiber ports 12

small form pluggable
 SFP 56

sockets
 1756-EN2T 73
 1756-EN2TR 73

software
 FactoryTalk Alarms and Events 41
 FactoryTalk Batch 41
 FactoryTalk View Site Edition 41
 optional 41
 programming software 74
 RSLinx communication software 74
 RSNetWorx for ControlNet 41
 RSNetWorx for EtherNet/IP 41
 RSVIEW32 41

status
 of qualification 63
 via module status display 162

status indicators
 1756-RM 170
 1756-RM2/A 170, 207
 1756-RM2XT/A 207
 CH1 209
 CH2 209
 use to troubleshoot 170

Studio 5000 Logix Designer 43
 use to troubleshoot 171

subnet 66

switchover 15
 description 16
 example 106
 locked attempts 108
 logic after 138
 monitor synchronization after 137
 test 164

synchronization
 automatic
 synchronization 97
 default 114
 description of 15
 monitor after switchover 137

Synchronization Status tab 102

Synchronization tab 99 - 102
 attempts log 100
 commands in 100

system
 qualification, system
 synchronization 15

system conversion 215

system overhead time slice 133
 optimize program 132

System Update commands
 abort system lock 105
 initiate locked switchover 106
 lock for update 104

System Update Lock Attempts 107

System Update tab 103 - 108
 commands 104 - 106
 Locked Switchover Attempts 108
 System Update Lock Attempts 107

T

tags
 manage 122

task 116
 continuous, execution 114
 optimize execution 131 - 136
 periodic 135
 recommended 114

time and date 98

transceiver
 SFP 56

troubleshoot 169 - 207
 check status indicators 170
 controller event 207
 EtherNet/IP

- lost connection 202
- lost EtherNet/IP connection 202
- missing redundancy module 205
- qualification abort 206
- redundancy module
 - lost connection 204
 - missing 205
- RMCT 190
- synchronization
 - keeper status 199
- use
 - RSNetWorx for ControlNet software 199
 - Studio 5000 Logix Designer 171

U

unicast

- communication module 18
- produced tags 73
- remote controller 72

Universal Remote I/O 35

unscheduled

- ControlNet network 81

unsupported feature

- motion 13
- SIL3 13

update

- RMCT 93
- system commands 104 - 106

update firmware 44

upgrade

- firmware 58 - 61

user program control 98

utilities

- BOOTP/DHCP 74

V

version

- RMCT 92

W

watchdog time 145, 232

workstation software 43

Rockwell Automation Support

Use the following resources to access support information.

Technical Support Center	Knowledgebase Articles, How-to Videos, FAQs, Chat, User Forums, and Product Notification Updates.	https://rockwellautomation.custhelp.com/
Local Technical Support Phone Numbers	Locate the phone number for your country.	http://www.rockwellautomation.com/global/support/get-support-now.page
Direct Dial Codes	Find the Direct Dial Code for your product. Use the code to route your call directly to a technical support engineer.	http://www.rockwellautomation.com/global/support/direct-dial.page
Literature Library	Installation Instructions, Manuals, Brochures, and Technical Data.	http://www.rockwellautomation.com/global/literature-library/overview.page
Product Compatibility and Download Center (PCDC)	Get help determining how products interact, check features and capabilities, and find associated firmware.	http://www.rockwellautomation.com/global/support/pcdc.page

Documentation Feedback

Your comments will help us serve your documentation needs better. If you have any suggestions on how to improve this document, complete the How Are We Doing? form at http://literature.rockwellautomation.com/idc/groups/literature/documents/du/ra-du002_-en-e.pdf.

Rockwell Automation maintains current product environmental information on its website at <http://www.rockwellautomation.com/rockwellautomation/about-us/sustainability-ethics/product-environmental-compliance.page>.

Allen-Bradley, ControlFLASH, ControlLogix, ControlLogix-XT, Control Tower, Data Highway Plus, FactoryTalk, FLEX I/O, Integrated Architecture, Logix5000, PanelView, PhaseManager, PlantPAx, POINT I/O, PowerFlex, Rockwell Automation, Rockwell Software, RSLinx, RSNetWorx, RSView, Stratix, Studio 5000 Automation & Engineering Design Environment, Studio 5000 Logix Designer, and VersaView are trademarks of Rockwell Automation, Inc.

CIP, CIP Sync, ControlNet, DeviceNet, and EtherNet/IP are trademarks of ODVA, Inc.

Trademarks not belonging to Rockwell Automation are property of their respective companies.

Rockwell Otomasyon Ticaret A.Ş., Kar Plaza İş Merkezi E Blok Kat:6 34752 İçerenköy, İstanbul, Tel: +90 (216) 5698400

www.rockwellautomation.com

Power, Control and Information Solutions Headquarters

Americas: Rockwell Automation, 1201 South Second Street, Milwaukee, WI 53204-2496 USA, Tel: (1) 414.382.2000, Fax: (1) 414.382.4444

Europe/Middle East/Africa: Rockwell Automation NV, Pegasus Park, De Kleetlaan 12a, 1831 Diegem, Belgium, Tel: (32) 2 663 0600, Fax: (32) 2 663 0640

Asia Pacific: Rockwell Automation, Level 14, Core F, Cyberport 3, 100 Cyberport Road, Hong Kong, Tel: (852) 2887 4788, Fax: (852) 2508 1846

Publication 1756-UM535G-EN-P - August 2018

Supersedes Publication 1756-UM535F-EN-P - March 2017

Copyright © 2018 Rockwell Automation, Inc. All rights reserved. Printed in the U.S.A.